

# SANTA CRUZ METROPOLITAN TRANSIT DISTRICT

BOARD OF DIRECTORS REGULAR MEETING AGENDA  
SEPTEMBER 10, 2004 (Second Friday of Each Month)  
SCMTD ENCINAL CONFERENCE ROOM\*  
"370 ENCINAL STREET, SUITE 100"  
SANTA CRUZ, CALIFORNIA  
9:00 a.m. – 11:00 a.m.

THE BOARD AGENDA PACKET CAN BE FOUND ONLINE AT [WWW.SCMTD.COM](http://WWW.SCMTD.COM)

**NOTE: THE BOARD CHAIR MAY TAKE ITEMS OUT OF ORDER**

**SECTION I: OPEN SESSION - 9:00 a.m.**

1. ROLL CALL
2. ORAL AND WRITTEN COMMUNICATION
  - a. Will Regan, VMU RE: Bart Cavallaro
3. LABOR ORGANIZATION COMMUNICATIONS
4. ADDITIONAL DOCUMENTATION TO SUPPORT EXISTING AGENDA ITEMS

**CONSENT AGENDA**

- 5-1. APPROVE REGULAR BOARD MEETING MINUTES OF AUGUST 13 AND AUGUST 27, 2004 AND THE SPECIAL MEETING MINUTES OF AUGUST 13, 2004  
Minutes: **THE AUGUST 27, 2004 MINUTES WILL BE PRESENTED FOR CONSIDERATION AT THE SEPTEMBER 24, 2004 BOARD MEETING**
- 5-2. ACCEPT AND FILE PRELIMINARILY APPROVED CLAIMS  
Report: Attached
- 5-3. ACCEPT AND FILE AUGUST 2004 RIDERSHIP REPORT  
Report: Attached  
**PAGE 1 OF THE RIDERSHIP REPORT WILL BE PRESENTED FOR CONSIDERATION AT THE SEPTEMBER 24, 2004 BOARD MEETING**
- 5-4. CONSIDERATION OF TORT CLAIMS: REJECT THE CLAIM ENTIRELY OF JOSE SAAVEDRA, CLAIM # 04-0016  
Claim: Attached

- 5-5. ACCEPT AND FILE THE METRO ADVISORY COMMITTEE (MAC) AGENDA FOR SEPTEMBER 22, 2004 AND MINUTES OF JULY 21, 2004  
Agenda/Minutes: Attached
- 5-6. ACCEPT AND FILE AGENDA FOR THE MASTF COMMITTEE MEETING OF SEPTEMBER 16, 2004 AND THE MINUTES OF THE AUGUST 19, 2004 MEETING  
Agenda/Minutes: **DOCUMENTATION WILL BE PRESENTED FOR CONSIDERATION AT THE SEPTEMBER 24, 2004 BOARD MEETING**
- 5-7. ACCEPT AND FILE PARACRUZ STATUS REPORT FOR JUNE 2004  
Staff Report: Attached
- 5-8. ACCEPT AND FILE HIGHWAY 17 STATUS REPORT FOR JULY 2004  
Staff Report: **DOCUMENTATION WILL BE PRESENTED FOR CONSIDERATION AT THE SEPTEMBER 24, 2004 BOARD MEETING**
- 5-9. ACCEPT AND FILE UNIVERSITY OF CALIFORNIA, SANTA CRUZ SERVICE UPDATE  
Staff Report: Attached
- 5-10. ACCEPT AND FILE METROBASE STATUS REPORT  
Staff Report: Attached
- 5-11. ACCEPT AND FILE MINUTES REFLECTING VOTING RESULTS FROM APPOINTEES TO THE SANTA CRUZ COUNTY REGIONAL TRANSPORTATION COMMISSION FOR THE JULY MEETING  
Staff Report: Attached
- 5-12. CONSIDERATION OF CONTRACT RENEWAL WITH DEVCO OIL FOR DISTRICT FUEL REQUIREMENTS  
Staff Report: Attached
- 5-13. CONSIDERATION OF CONTRACT RENEWAL WITH CLAREMONT BEHAVIORAL SERVICES FOR EMPLOYEE ASSISTANCE PROGRAM  
Staff Report: Attached
- 5-14. CONSIDERATION OF ADOPTING A **RESOLUTION** ESTABLISHING A PETTY CASH FUND FOR THE PARACRUZ FACILITY  
Staff Report: Attached  
**ACTION REQUIRED AT THE SEPTEMBER 10, 2004 BOARD MEETING**
- 5-15. CONSIDERATION OF APPROVAL OF CALPERS **RESOLUTIONS** TO FIX AND SET THE DISTRICT'S MEDICAL PREMIUM CONTRIBUTION RATES  
Staff Report: Attached  
**ACTION REQUIRED AT THE SEPTEMBER 10, 2004 BOARD MEETING**

- 5-I 6. CONSIDERATION OF MODIFICATION TO CURRENT CLASS SPECIFICATION (JOB DESCRIPTION) OF THE PARTS CLERK TO REPLACE THE CLASS B DRIVERS LICENSE REQUIREMENT WITH A CLASS C RIVER'S LICENSE REQUIREMENT

Staff Report: Attached

- 5-I 7. CONSIDERATION OF APPROVAL OF PARATRANSIT CLASS SPECIFICATIONS (JOB DESCRIPTIONS) FOR PARATRANSIT OPERATOR, RESERVATIONIST, DISPATCH/ SCHEDULER, RESERVATION/SCHEDULING COORDINATOR, TRAINING AND ROAD RESPONSE COORDNATOR, MECHANIC II, AND SUPERINTENDENT

Staff Report: Attached

**ACTION REQUIRED AT THE SEPTEMBER 10, 2004 BOARD MEETING**

- 5-I 8. NOTIFICATION OF ACTIONS TAKEN IN CLOSED SESSION REGARDING THE SETTLEMENT WITH GUILLERMO CHAVEZ

Staff Report: Attached

- 5-I 9. CONSIDERATION OF A **RESOLUTION** OF APPRECIATION AND REMEMBRANCE FOR THE SERVICES OF BART CAVALLARO AS A MEMBER OF THE BOARD OF DIRECTORS FOR THE SANTA CRUZ METROPOLITAN TRANSIT DISTRICT

Resolution: Attached

**REGULAR AGENDA**

6. PRESENTATION OF EMPLOYEE LONGEVITY AWARDS

Presented by: Chairperson Reilly

Staff Report: Attached

**THIS PRESENTATION WILL TAKE PLACE AT THE SEPTEMBER 24, 2004 BOARD MEETING**

7. CONSIDERATION OF RECEIPT OF REPORT REGARDING THE SANTA CRUZ COUNTY REGIONAL TRANSPORTATION COMMISSION'S PARATRANSIT COORDINATION TASK FORCE (PCTF) AND DRAFT MINUTES OF AUGUST 18, 2004

Presented by: Director Pat Spence

Staff Report: AUGUST 18, 2004 Draft Minutes are attached

8. CONSIDERATION OF AUTHORIZING THE GENERAL MANAGER TO EXECUTE A CONTRACT TO PURCHASE A VERTICAL LNG STORAGE TANK FOR AN LCNG FUELING STATION FOR THE METROBASE PROJECT

Presented by: Frank Cheng, Project Manager

Staff Report: Attached

**ACTION REQUIRED AT THE SEPTEMBER 10, 2004 BOARD MEETING**

9. CONSIDERATION OF AUTHORIZING THE GENERAL MANAGER TO EXECUTE A CONTRACT TO PURCHASE TWO PRESSURE VESSEL ASSEMBLIES FOR THE LCNG FUELING STATION FOR THE METROBASE PROJECT  
Presented by: Frank Cheng, MetroBase Project Manager  
Staff Report: Attached  
**ACTION REQUIRED AT THE SEPTEMBER 10, 2004 BOARD MEETING**
  
10. CONSIDERATION OF AWARD OF CONTRACT FOR GOODWILL LOSS APPRAISAL SERVICES FOR METROBASE PROPERTIES  
Presented by: Tom Stickel, Fleet Maintenance Manager  
Staff Report: Attached  
**ACTION REQUIRED AT THE SEPTEMBER 10, 2004 BOARD MEETING**
  
11. CONSIDERATION OF AWARD OF CONTRACT FOR SUPPLEMENTAL PARATRANSIT SERVICES  
Presented by: Tom Stickel, Fleet Maintenance Manager  
Staff Report: **DOCUMENTATION WILL BE PRESENTED FOR CONSIDERATION AT THE SEPTEMBER 24, 2004 BOARD MEETING**
  
12. CONSIDERATION OF APPROVAL OF **RESOLUTION** TO MODIFY SANTA CRUZ METRO'S BYLAWS INCLUDING:
  - A. CLARIFYING THAT APPOINTEES TO THE METROS ADVISORY COMMITTEE (MAC) SERVE AT THE PLEASURE OF THE BOARD OF DIRECTORS; AND
  
  - B. ADDING RULES OF PROCEDURE FOR BOARD MEETINGS, SELECTING REPRESENTATIVES TO THE SANTA CRUZ COUNTY REGIONAL TRANSPORTATION COMMISSION, SETTING TIME LIMITS FOR TESTIMONY ON AGENDA ITEMS AND OTHER CHANGES  
Presented by: Margaret Gallagher, District Counsel  
Staff Report: Attached
  
13. CONSIDERATION OF APPOINTING A PERMANENT METRO ADVISORY COMMITTEE (MAC) REPRESENTATIVE TO THE PARATRANSIT COORDINATION TASK FORCE (PCTF)  
Presented by: Les White, General Manager  
Staff Report: **DOCUMENTATION WILL BE PRESENTED FOR CONSIDERATION AT THE SEPTEMBER 24, 2004 BOARD MEETING**
  
14. CONSIDERATION OF APPOINTMENT OF DIRECTORS TO THE SANTA CRUZ CIVIC IMPROVEMENT CORPORATION  
Presented by: Elizabeth Ross, Finance Manager  
Staff Report: Attached

15. CONSIDERATION OF PARACRUZ TRANSITION STATUS REPORT  
Presented by: Bryant Baehr, Operations Manager  
Staff Report: **DOCUMENTATION WILL BE PRESENTED FOR CONSIDERATION AT THE SEPTEMBER 24, 2004 BOARD MEETING**
16. CONSIDERATION OF AUTHORIZING THE GENERAL MANGER TO EXECUTE AN AMENDMENT TO THE RNL DESIGN CONTRACT FOR ARCHITECTURAL/ENGINEERING SERVICES FOR THE METROBASE PROJECT  
Presented by: Frank Cheng, Project Manager  
Staff Report: Attached
17. CONSIDERATION OF APPROVAL OF 40 YEAR LEASE WITH THE CITY OF SANTA CRUZ FOR PROPERTY NEEDED FOR THE METROBASE PROJECT  
Presented by: Frank Cheng, Project Manager  
Staff Report: **DOCUMENTATION WILL BE PRESENTED FOR CONSIDERATION AT THE SEPTEMBER 24, 2004 BOARD MEETING**
18. CONSIDERATION OF AUTHORIZING THE GENERAL MANAGER TO EXECUTE A LEASE AGREEMENT WITH IULIANO 1977 TRUST FOR PROPERTY LOCATED AT 111 DUBOIS STREET FOR METROBASE PROJECT  
Presented by: Frank Cheng, Project Manager  
Staff Report: **DOCUMENTATION WILL BE PRESENTED FOR CONSIDERATION AT THE SEPTEMBER 24, 2004 BOARD MEETING**
19. CONSIDERATION OF AUTHORIZING THE GENERAL MANAGER TO EXECUTE A SUBLEASE AGREEMENT WITH FREDERICK ELECTRONICS (PLANTRONICS) FOR PROPERTY LOCATED AT 375 ENCINAL STREET FOR METROBASE PROJECT TO ASSIGN THE PROPERTY TO A TOOL SHED  
Presented by: Frank Cheng, Project Manager  
Staff Report: **DOCUMENTATION WILL BE PRESENTED FOR CONSIDERATION AT THE SEPTEMBER 24, 2004 BOARD MEETING**
20. CONSIDERATION OF AUTHORIZING THE GENERAL MANAGER TO EXECUTE A LEASE AMENDMENT WITH THE SCOTTS VALLEY TRANSIT CENTER TENANT TO EXTEND THE TERM, INCLUDE JANITORIAL DUTIES AND PROVIDE FOR THE REPAYMENT OF A PG&E BILL  
Presented by: Margaret Gallagher, District Counsel  
Staff Report: Attached
21. REVIEW OF ITEMS TO BE DISCUSSED IN CLOSED SESSION: District Counsel

22. ORAL AND WRITTEN COMMUNICATIONS REGARDING CLOSED SESSION

**SECTION II: CLOSED SESSION**

1. CONFERENCE WITH LEGAL COUNSEL – EXISTING LITIGATION  
(Pursuant to Subdivision (a) of Section 54956.9)
  - a. Name of Case: Sonia McClure v. Santa Cruz Metropolitan Transit District (Before the Workers' Compensation Appeals Board)
  
2. CONFERENCE WITH LEGAL COUNSEL – EXISTING LITIGATION  
(Pursuant to Subdivision (a) of Section 54956.9)
  - a. Name of Case: Freddy Castillo v. Santa Cruz Metropolitan Transit District

**SECTION III: RECONVENE TO OPEN SESSION**

23. REPORT OF CLOSED SESSION

**ADJOURN**

**NOTICE TO PUBLIC**

Members of the public may address the Board of Directors on a topic not on the agenda but within the jurisdiction of the Board of Directors or on the consent agenda by approaching the Board during consideration of Agenda Item #2 "Oral and Written Communications", under Section I. Presentations will be limited in time in accordance with District Resolution 69-2-I.

When addressing the Board, the individual may, but is not required to, provide his/her name and address in an audible tone for the record.

Members of the public may address the Board of Directors on a topic on the agenda by approaching the Board immediately after presentation of the staff report but before the Board of Directors' deliberation on the topic to be addressed. Presentations will be limited in time in accordance with District Resolution 69-2-I.

The Santa Cruz Metropolitan Transit District does not discriminate on the basis of disability. The Encinal Conference Room is located in an accessible facility. Any person who requires an accommodation or an auxiliary aid or service to participate in the meeting, please contact Cindi Thomas at 831-426-6080 as soon as possible in advance of the Board of Directors meeting. Hearing impaired individuals should call 711 for assistance in contacting METRO regarding special requirements to participate in the Board meeting.

September 2, 2004

Board of Directors  
Santa Cruz Metropolitan Transit District  
370 Encinal St, Suite 100  
Santa Cruz, Ca 95060

Dear Metro Board Members:

It is with great sadness that I have learned of the untimely passing of ex Board member Bart Cavallaro. Many employees of the District have not had the occasion to meet or work with the many Board members who have served on the Board since the inception of the District. I have been fortunate to have attended Board meetings for many years and know very well how hard so many have worked for the betterment of Metro.

As a Board member for 19 years, Bart was a true shining star in his tireless support of Metro. So very many in our community will never know or understand how positive his hard work, dedication and caring have touched and improved all our lives.

I know I speak for all the VMU members when I send my deepest condolences to the family and many friends of Bart. He will be missed.



Will Regan, VMU President

2-9.1

# SANTA CRUZ METROPOLITAN TRANSIT DISTRICT

Minutes- Board of Directors

August 13, 2004

A Regular Meeting of the Board of Directors of the Santa Cruz Metropolitan Transit District met on Friday, August 13, 2004 at the District's Administrative Office, 370 Encinal Street, Santa Cruz, CA.

Vice Chair Keogh called the meeting to order at 9:39 a.m.

## SECTION 1: OPEN SESSION

### 1. ROLL CALL:

#### DIRECTORS PRESENT

Sheryl Ainsworth  
Jan Beautz  
Michelle Hinkle  
Mike Keogh  
Emily Reilly  
Mike Rotkin  
Dale Skillicorn  
Pat Spence  
Mark Stone  
Marcela Tavantzis

#### DIRECTORS ABSENT

Dennis Norton  
Ex-Officio Wes Scott

#### STAFF PRESENT

|  |                                       |
|--|---------------------------------------|
| Bryant Baehr,, Operations Manager , ,    | Robyn Slater, Human Resources Manager |
| Margaret Gallagher, District Counsel     | Judy Souza, Base Superintendent       |
| Steve Paulson, Paratransit Administrator | Tom Stickel, Fleet Maint. Manager     |
| Elisabeth Ross, Finance Manager          | Les White, General Manager            |

#### EMPLOYEES AND MEMBERS OF THE PUBLIC WHO VOLUNTARILY INDICATED THEY WERE PRESENT

|                           |                       |
|---------------------------|-----------------------|
| Chuck Boxwell, RNL Design | Paul Marcelin-Sampson |
| Kate Diamond, RNL Design  | Bonnie Morr, UTU      |
| Joni Janecki, JWA         | Will Regan, VMU       |
| Jeff Le Blanc, MASTF      | Bob Yount, MASTF      |
| Gary Klemz, SEIU          |                       |

### 2. ORAL AND WRITTEN COMMUNICATION

#### Oral:

Vice Chair Keogh announced that action is required today on Item #11, but not on Item #5-15. Les White reported that no action is required today on Item # 5-18 due to MAC

5-1.1



member Lesley Wright being unable to attend the August Paratransit Coordination Task Force meeting and no response had been received from the MAC Chair regarding recommending a replacement.

An announcement was made that Director Scott's son, Jonathan Scott, had recently passed away and a memorial is planned for 2:30 p.m. on Sunday, August 15, 2004 at Twin Lakes Church in Aptos.

Written:

None

3. **LABOR ORGANIZATION COMMUNICATIONS**

None.

4. **ADDITIONAL DOCUMENTATION TO SUPPORT EXISTING AGENDA ITEMS**

None. Due to time constraints, Items # 14 and 15 were taken out of order before the Consent Agenda.

**ACTION: MOTION: DIRECTOR TAVANTZIS SECOND: DIRECTOR ROTKIN**

**Take Items # 14 and 15 before the Consent Agenda:**

**Motion passed unanimously with Directors Norton and Scott being absent.**

14. **REVIEW OF REBUILD VS. REMODEL DESIGN OPTIONS FOR THE METROBASE PROJECT MAINTENANCE BUILDING,**

**Summary:**

Les White introduced Chuck Boxwell and Kate Diamond from RNL Design, who gave a presentation on rebuild vs. remodel options, schedule and cost for the MetroBase Maintenance Building on Golf Club Drive.

**Discussion:**

The existing building is twenty years old, has a sloped floor and is past its projected useful life. A completely new building would have a level floor; and the same square footage, but with more useable space. There was discussion about the project being "green" by using locally manufactured and recycled materials, and using natural daylight. Construction of a new building would add approximately 2-3 months, but would not affect the schedule for the LCNG Fueling Station. The overall project cost would be approximately the same. However, design costs, demolition cost and construction costs would be approximately \$490,000 above the remodel cost before the change order contingencies are added.

**Direction:**

The Board requested that more details regarding the total additional cost be brought back to the August 27, 2004 meeting.

**15. REVIEW OF AESTHETIC TREATMENT DESIGN OPTIONS FOR THE OPERATIONS, SERVICE, AND MAINTENANCE BUILDINGS FOR THE METROBASE PROJECT**

**Summary:**

The RNL Design Team (Chuck Boxwell and Kate Diamond from RNL-design, and Joni Janecki from JWA) asked the Board for input on colors, finishes, exposed materials, carpets, tiles and other components that will affect the overall appearance of the MetroBase facilities.

**Discussion:**

The RNL Design Team answered questions and showed examples of materials for the Board make selections from, explaining that recycled, locally made materials and 'native, drought tolerant plants will be used. The Design Team 'is in synch with what Art Space is proposing at the Tannery site, and also has taken into consideration steps necessary to prevent mold from forming.

**VICE CHAIR KEOGH TURNED THE MEETING OVER TO CHAIR REILLY AT THIS TIME AND THEN LEFT THE MEETING**

**CONSENT AGENDA**

Chair Reilly announced that due to time constraints, she not review each Consent Agenda Item individually, but rather asked if there were any comments or questions that anyone wanted to raise on a particular Consent Agenda Item.

Paul Marcelin-Sampson asked the Board to consider responding to the negative articles in the Sentinel regarding Highway 17 drivers. Mr. Marcelin also pointed out that the Paratransit Coordination Task Force minutes included in today's Agenda Packet are actually draft minutes, but not labeled as such. Director Beautz responded that they would be labeled "draft" going forward.

**REGULAR AGENDA**

**6. PRESENTATION OF EMPLOYEE LONGEVITY AWARDS**

This presentation will take place at the August 27, 2004 Board Meeting.

**7. CONSIDERATION OF RECEIPT OF THE SANTA CRUZ COUNTY REGIONAL TRANSPORTATION COMMISSION'S PARATRANSIT COORDINATION TASK FORCE (PCTF) AND MINUTES OF JUNE 16, 2004**

**Summary:**

Director Spence encouraged Board members to attend the next meeting being held at 2:00 p.m. August 18, 2004 in the ABC Room of the Santa Cruz Civic Auditorium. Margaret Gallagher will make a presentation at the meeting regarding the ADA legal mandates.

8. **CONSIDERATION OF APPROVAL OF 40 YEAR LEASE WITH THE CITY OF SANTA CRUZ FOR PROPERTY NEEDED FOR THE METROBASE PROJECT**

Documentation will be presented for consideration at the August 27, 2004 Board Meeting.

9. **AWARD CONTRACT FOR GOODWILL Loss APPRAISAL SERVICES ACTION REQUIRED AT THE JULY 9, 2004 BOARD MEETING**

Documentation will be presented for consideration at the August 27, 2004 Board Meeting.

10. **CONSIDERATION OF MODIFICATIONS TO SANTA CRUZ METRO'S BYLAWS TO CLARIFY THAT APPOINTEES TO THE METROS ADVISORY COMMITTEE (MAC) SERVE AT THE PLEASURE OF THE BOARD OF DIRECTORS**

Paul Marcelin-Sampson asked the Board to consider adding language to the bylaws clarifying that the Board does not intend to remove MAC members based on their point of view.

11. **CONSIDERATION OF AUTHORIZING THE GENERAL MANAGER TO EXECUTE A LEASE AGREEMENT WITH SOQUEL III ASSOCIATES FOR PROPERTY LOCATED AT 2880 RESEARCH PARK DRIVE, SUITE 160 FOR METRO PARACRUZ OPERATION**

ACTION REQUIRED AT THE AUGUST 13, 2004 BOARD MEETING

**Summary:**

Bryant Baehr reported that Greg Walsh of J.R. Parrish has helped Staff locate a suitable property for in-house ParaCruz operations at 2880 Research Park Drive. Of the 10 properties viewed, this property is the only one that met all the criteria necessary for a November 1, 2004 start date. The owner, Soquel III Associates, is proposing a five (5) year lease with two (2) five (5) year options, with three (3) months rent-free.

**Discussion:**

Mr. Baehr reported that the County of Santa Cruz and the Central Fire District have approved the use of this property for ParaCruz operations, including light maintenance. There was discussion regarding the lack of specifically designated parking spaces.

**ACTION: MOTION: DIRECTOR ROTKIN SECOND: DIRECTOR REILLY**

**Authorize the General Manager to execute a lease with Soquel III Associates for property located at 2880 Research Park Drive, Suite 160, for ParaCruz operations and send Board members a copy of the agreement prior to final signature.**

5-1.4

Director Beautz added the following friendly amendment, which was accepted by Director Rotkin:

**Attempt to obtain designated parking spaces with the understanding that Staff may need to take full responsibility regarding enforcement of designated parking spaces and if Soquel III does not agree, then the matter needs to be brought back to the Board of Directors.**

Gary Klemz expressed concern that providing in-house ParaCruz service & costing \$80,000 more than not taking the service in-house, while employees are being laid off.

Director Rotkin clarified that the costs would have been higher to remain with Community Bridges or go with a brokerage service.

**Motion passed unanimously with Directors Keogh, Norton and Scott being absent.**

12. **CONSIDERATION OF APPOINTING A PERMANENT METRO ADVISORY COMMITTEE (MAC) REPRESENTATIVE TO THE PARATRANSIT COORDINATION TASK FORCE (PCTF)**

Documentation will be presented for consideration at the August 27, 2004 Board Meeting.

13. **CONSIDERATION OF MODIFYING THE BYLAWS OF THE METRO ADVISORY COMMITTEE (MAC) TO PROVIDE FOR ALTERNATE MEMBERS**

**ACTION: MOTION: DIRECTOR ROTKIN SECOND: DIRECTOR SPENCE**

**Move this item to the Consent Agenda for the August 27, 2004 Board Meeting.**

**Motion passed unanimously with Directors Keogh, Norton and Scott being absent.**

16. **CONSIDERATION OF APPROVAL OF RESOLUTION TO MODIFY SANTA CRUZ METRO'S BYLAWS INCLUDING ADDING RULES OF PROCEDURE FOR BOARD MEETINGS, SELECTING REPRESENTATIVES TO THE SANTA CRUZ COUNTY REGIONAL TRANSPORTATION COMMISSION, SETTING TIME LIMITS FOR TESTIMONY ON AGENDA ITEMS AND OTHER NEEDED FOR THE METROBASE PROJECT**

Documentation will be presented for consideration at the August 27, 2004 Board Meeting.

**ADJOURN**

**5-1.5**

There being no further business, Chair Reilly adjourned the meeting at 11:25 a.m.

Respectfully submitted,



CINDI THOMAS  
Administrative Services Coordinator

DRAFT

# SANTA CRUZ METROPOLITAN TRANSIT DISTRICT

SPECIAL Meeting Minutes- Board of Directors

August 13, 2004

A SPECIAL Meeting of the Board of Directors of the Santa Cruz Metropolitan Transit District met on Friday, August 13, 2004 at the Administrative Offices, 370 Encinal Street, Santa Cruz, CA.

Vice Chair Keogh called the meeting to order at 8:00 a.m.

## SECTION 1: OPEN SESSION

### 1. ROLL CALL:

#### DIRECTORS PRESENT

Michelle Hinkle  
Mike Keogh  
Mike Rotkin  
Dale Skillicorn  
Pat Spence  
Mark Stone  
Marcela Tavantzis

#### DIRECTORS ABSENT

Sheryl Ainsworth  
Jan Beautz ,  
Dennis Norton  
Emily Reilly ,  
Ex-Officio Wes Scott

#### STAFF PRESENT

Margaret Gallagher, District Counsel  
Les White; General Manager

### 2. REVIEW OF ITEMS TO BE DISCUSSED IN CLOSED SESSION :

Margaret Gallagher reported that the Board would be evaluating the General Manager's job performance.

### 2. ORAL AND WRITTEN COMMUNICATIONS REGARDING CLOSED SESSION

Staff was directed to send a letter of condolence to Director Scott for the recent loss of his son.

## SECTION II: CLOSED SESSION

### 1. PUBLIC EMPLOYEE PERFORMANCE EVALUATION

Pursuant to Government Code Section 54957

Title: General Manager

5-1.7

**SECTION III: RECONVENE TO OPEN SESSION**

**3. REPORT OF CLOSED SESSION**

Margaret Gallagher stated that the Board had done a performance evaluation of the General Manager, whom they agreed is doing an excellent job.

ADJOURN

There being no further business, Vice Chair Keogh adjourned the SPECIAL meeting at 9:39 a.m.

Respectfully submitted,



CINDI THOMAS

Administrative Services Coordinator

CHECK JOURNAL DETAIL BY CHECK NUMBER  
ALL CHECKS FOR COAST COMMERCIAL BANK

DATE: 08/01/04 THRU 08/31/04

| CHECK NUMBER   | CHECK DATE | CHECK AMOUNT | VENDOR NAME                           | VENDOR TRANS. TYPE | TRANS. NUMBER | TRANSACTION DESCRIPTION | TRANSACTION AMOUNT | COMMENT  |
|----------------|------------|--------------|---------------------------------------|--------------------|---------------|-------------------------|--------------------|----------|
| 11711P08/01/04 |            | -596.40      | M006 VAN DER ZANDE, ED<br>VOID CHECK  |                    | 2336          | VOID CHECK              | -596.40            | PRE-PAID |
| 13063          | 08/06/04   | 481.68       | 001 SBC                               |                    | 2024          | JUL PHONE LINES         | 86.38              |          |
|                |            |              |                                       |                    | 2025          | JUL PHONES              | 395.30             |          |
| 13064          | 08/06/04   | 1,982.06     | 001019 HOLDSWORTH NORTH AMERICA       |                    | 2026          | WOOL MATERIAL 1886      | 1,982.06           |          |
| 13065          | 08/06/04   | 825.00       | 001027 OVERLAND PACIFIC & CUTLER, INC |                    | 2027          | MB PROF SVCS JUN04      | 825.00             |          |
| 13066          | 08/06/04   | 1,500.00     | 001032 ARK PROPERTY MAINTENANCE       | 7                  | 2028          | JUL CUSTODIAL SVCS      | 1,500.00           |          |
| 13067          | 08/06/04   | 10,518.17    | 001043 VISION SERVICE PLAN            |                    | 2029          | AUG VISION INSURANCE    | 10,518.17          |          |
| 13068          | 08/06/04   | 298.76       | 001063 NEW FLYER INDUSTRIES LIMITED   |                    | 2030          | REV VEH PARTS 6         | 5.56               |          |
|                |            |              |                                       |                    | 2113          | REV VEH PARTS 293       | 293.20             |          |
| 13069          | 08/06/04   | 523.10       | 001315 WASTE MANAGEMENT               |                    | 2031          | JUL MT HERMON/KINGS     | 41.87              |          |
|                |            |              |                                       |                    | 2032          | JUL KINGS VILLAGE       | 142.95             |          |
|                |            |              |                                       |                    | 2033          | JUL-SEP LOMOND/HY       | 37.98              |          |
|                |            |              |                                       |                    | 2034          | JUL-SEP BIG BASIN/HY    | 37.98              |          |
|                |            |              |                                       |                    | 2035          | JUL-SEP AIRPORT/FREE    | 262.32             |          |
| 13070          | 08/06/04   | 106,065.91   | 001316 DEVCO OIL                      |                    | 2036          | JUL FUEL                | 106,065.91         |          |
| 13071          | 08/06/04   | 5,000.00     | 001365 BORTNICK, ROBERT S. & ASSOC.   | 7                  | 2037          | CALL STOP SURVEY        | 5,000.00           |          |
| 13072          | 08/06/04   | 967.00       | 001523 SANTA CRUZ MEDICAL CLINIC      | 7                  | 2114          | JUN MEDICAL EXAMS       | 967.00             |          |
| 13073          | 08/06/04   | 17,223.53    | 001616 UNUM                           |                    | 2038          | AUG LTD INSURANCE       | 17,223.53          |          |
| 13074          | 08/06/04   | 77.18        | 001645 ERIK'S DELICAFE, INC.          |                    | 2039          | LOCAL MEETING EXP       | 77.18              |          |
| 13075          | 08/06/04   | 34.35        | 001944 SANTA CRUZ COUNTY LAW LIBRARY  |                    | 2040          | COPIES/LEGAL            | 34.35              |          |
| 13076          | 08/06/04   | 445.14       | 001A SBC/MCI                          |                    | 2041          | JUL PHONE/IT            | 91.94              |          |

5-2.1



|        |          |                 |                                |      |                      |                    |
|--------|----------|-----------------|--------------------------------|------|----------------------|--------------------|
|        |          |                 |                                | 2042 | JUL PHONE/IT         | 176.60             |
|        |          |                 |                                | 2043 | JUL PHONE/IT         | 176.60             |
| 13077  | 08/06/04 | 73.50 002063    | COSTCO                         | 2044 | LOCAL MEETING EXP    | 12.16              |
|        |          |                 |                                | 2045 | COFFEE CLUB SUPPLIES | 61.34              |
| 13078  | 08/06/04 | 12.10 002069    | A TOOL SHED, INC.              | 2046 | EQUIPMENT RENTAL     | 12.10              |
| 13079  | 08/06/04 | 2,000.00 002267 | SHAW & YODER, INC.             | 2047 | JUN LEGISLATIVE SVCS | 2,000.00           |
| 13080  | 08/06/04 | 3,750.00 002346 | CHANEY, CAROLYN & ASSOC., INC. | 2048 | AUG LEGISLATIVE SVCS | 3,750.00           |
| 13081  | 08/06/04 | 949.18 002504   | TIFCO INDUSTRIES               | 2049 | PARTS & SUPPLIES     | 949.18             |
| 13082  | 08/06/04 | 1,887.75 002607 | CTC ANALYTICAL SERVICES        | 2050 | OUT REPAIR REV VEH   | 1,887.75           |
| 13083  | 08/06/04 | 426.30 002713   | SANTA CRUZ AUTO TECH, INC.     | 2051 | OUT REPAIR/#8020     | 426.30             |
| 13084  | 08/06/04 | 296.83 007      | UNITED PARCEL SERVICE          | 2052 | JUN/JUL FREIGHT OUT  | 296.83             |
| 13085  | 08/06/04 | 93.41 009       | PACIFIC GAS & ELECTRIC         | 2053 | 6/15-7/14 PAUL SWT   | 82.07              |
|        |          |                 |                                | 2054 | 6/26-7/28 SAKATA     | 11.34              |
| 13086  | 08/06/04 | 828.00 017      | SUN MICROSYSTEMS, INC.         | 2055 | 7/1-9/30 SVCS        | 828.00             |
| 13087  | 08/06/04 | 378.69 020      | ADT SECURITY SERVICES INC.     | 2056 | AUG ALARMS           | 378.69             |
| 13088  | 08/06/04 | 482.88 061      | REGISTER PAJARONIAN            | 2057 | DISPLAY AD           | 482.88             |
| 13089  | 08/06/04 | 75.96 061A      | REGISTER PAJARONIAN            | 2058 | CLASSIFIED AD        | 75.96              |
| 13090  | 08/06/04 | 83.35 074       | KENVILLE LOCKSMITHS            | 2059 | JUL LOCKS/KEYS       | 83.35              |
| 13091  | 08/06/04 | 213.90 107      | SAN LORENZO LUMBER             | 2060 | REPAIRS/MAINTENANCE  | 213.90             |
| 13092  | 08/06/04 | 2,354.58 110    | JESSICA GROCERY STORE, INC.    | 2061 | JUL CUSTODIAN SVCS   | 2,354.58           |
| 13092P | 08/05/04 | -2,354.58 110   | JESSICA GROCERY STORE, INC.    | 2334 | VOID CHECK           | -2,354.58 PRE-PAID |
|        |          |                 | VOID CHECK                     |      |                      |                    |
| 13093  | 08/06/04 | 1,762.02 117    | GILLIG CORPORATION             | 2062 | REV VEH PARTS        | 1,762.02           |
| 13094  | 08/06/04 | 1,871.78 130    | CITY OF WATSONVILLE UTILITIES  | 2063 | CONTAINER RODRIGUEZ  | 1,282.64           |
|        |          |                 |                                | 2064 | 5/4-7/1 RODRIGUEZ    | 486.27             |
|        |          |                 |                                | 2065 | 5/4-7/1 RODRIGUEZ    | 60.02              |
|        |          |                 |                                | 2066 | 5/4-7/1 RODRIGUEZ    | 42.85              |
| 13095  | 08/06/04 | 874.42 166      | HOSE SHOP, THE                 | 2067 | REPAIRS/MAINTENANCE  | 46.08              |

S-2.2

## CHECK JOURNAL DETAIL BY CHECK NUMBER

ALL CHECKS FOR COAST COMMERCIAL BANK

DATE: 08/01/04 THRU 08/31/04

| CHECK NUMBER | CHECK DATE | CHECK VENDOR AMOUNT | VENDOR NAME                   | VENDOR TRANS. TYPE | TRANS. NUMBER | TRANSACTION DESCRIPTION | TRANSACTION COMMENT AMOUNT |
|--------------|------------|---------------------|-------------------------------|--------------------|---------------|-------------------------|----------------------------|
|              |            |                     |                               |                    | 2115          | REV VEH PARTS/SUPPLY    | 828.34                     |
| 13096        | 08/06/04   | 60.00 271           | CARLSON, BRENT D., M.D., INC. | 7                  | 2068          | JUL DRUG TESTING        | 60.00                      |
| 13097        | 08/06/04   | 91.70 282           | GRAINGER                      |                    | 2069          | WATER DISP/MET          | 91.70                      |
| 13098        | 08/06/04   | 242.68 291          | STANLEY ACCESS TECHNOLOGIES   |                    | 2070          | REPAIR METRO DOOR       | 242.68                     |
| 13099        | 08/06/04   | 1,460.00 351        | BEI CORPORATION               |                    | 2071          | SW MAINT (8/1-7/30)     | 1,460.00                   |
| 13100        | 08/06/04   | 88.23 372           | FEDERAL EXPRESS               |                    | 2072          | JUN/JUL MAILINGS/ADM    | 88.23                      |
| 13101        | 08/06/04   | 8,113.33 378        | STEWART & STEVENSON           |                    | 2073          | REBUILD TRANSMISSION    | 8,113.33                   |
| 13102        | 08/06/04   | 8.51 418            | COUNTY OF SANTA CRUZ          |                    | 2074          | CNG FUEL                | 8.51                       |
| 13103        | 08/06/04   | 164.00 434          | VERIZON WIRELESS-PAGERS       |                    | 2075          | AUG PAGERS              | 164.00                     |
| 13104        | 08/06/04   | 252.27 448          | UNISOURCE                     |                    | 2076          | COPY PAPER/ADM          | 252.27                     |
| 13105        | 08/06/04   | 248.00 497B         | APTA                          |                    | 2116          | DBE FY05 ADVERTISMNT    | 248.00                     |
| 13106        | 08/06/04   | 237,410.90 502      | CA PUBLIC EMPLOYEES'          |                    | 2077          | AUG MEDICAL INS         | 237,410.90                 |
| 13107        | 08/06/04   | 540,814.00 588      | CALTIP                        |                    | 2078          | 04/05 LIABILITY INS     | 458,518.00                 |
|              |            |                     |                               |                    | 2079          | 04/05 PHYS DAMAGE       | 82,296.00                  |
| 13108        | 08/06/04   | 1,987.91 647        | GFI GENFARE                   |                    | 2080          | REV VEH PARTS           | 1,987.91                   |
| 13109        | 08/06/04   | 90.35 667           | CITY OF SCOTTS VALLEY         |                    | 2081          | 5/15-7/15 KINGS VLG     | 90.35                      |
| 13110        | 08/06/04   | 70.00 682           | WEISS, AMY L.                 | 7                  | 2082          | PROF SVCS 7/23          | 70.00                      |
| 13111        | 08/06/04   | 9,056.25 683        | TRISTAR RISK MANAGEMENT       |                    | 2083          | AUG WC SVC FEE          | 9,056.25                   |
| 13112        | 08/06/04   | 849.70 733          | CLAREMONT BEHAVIORAL SERVICES |                    | 2084          | AUG EAP PREMIUM         | 849.70                     |
| 13113        | 08/06/04   | 2,593.41 809        | IBM CORPORATION               |                    | 2085          | SW MAINT 7/04-6/05      | 2,593.41                   |
| 13114        | 08/06/04   | 29.11 848           | SANTA CRUZ ELECTRONICS, INC.  |                    | 2086          | COMPUTER SUPPLIES/IT    | 29.11                      |
| 13115        | 08/06/04   | 39,160.09 875       | PACIFICARE DENTAL             |                    | 2087          | AUG DENTAL              | 39,160.09                  |

5-2-3

|       |          |            |      |                               |      |                      |            |
|-------|----------|------------|------|-------------------------------|------|----------------------|------------|
| 13116 | 08/06/04 | 5,000.00   | 897  | GAULT STREET SENIOR HOUSING   | 2088 | BUS SHELTER          | 5,000.00   |
| 13117 | 08/06/04 | 90.00      | 898  | JAFFEE, DENISE AND            | 2089 | REFUND PT COUPONS    | 90.00      |
| 13118 | 08/06/04 | 199,125.62 | 904  | RNL DESIGN                    | 2117 | PROF SVCS THRU 5/31  | 74,696.54  |
|       |          |            |      |                               | 2118 | REIMBRS EXP TO 5/31  | 2,036.52   |
|       |          |            |      |                               | 2119 | PROF SVCS THRU 6/30  | 118,740.80 |
|       |          |            |      |                               | 2120 | REIMBRS EXP TO 6/30  | 3,651.76   |
| 13119 | 08/06/04 | 2,837.57   | 909  | CLASSIC GRAPHICS              | 2121 | OUT REPAIR REV VEH   | 2,837.57   |
| 13120 | 08/06/04 | 1,440.00   | 914  | CALTRONICS BUSINESS SYSTEMS   | 2122 | MAINT COPIERS/FLEET  | 1,440.00   |
| 13121 | 08/06/04 | 692.00     | 950  | PARADISE LANDSCAPE            | 2090 | JUL MAINT/PEST CNTRL | 692.00     |
| 13122 | 08/06/04 | 63,797.53  | 975  | TRISTAR RISK MANAGEMENT NO. 2 | 2091 | JUL TRUST ACCOUNT    | 63,797.53  |
| 13123 | 08/06/04 | 50.00      | B001 | AINSWORTH, SHERYL             | 2101 | JUL BOARD MEETING    | 50.00      |
| 13124 | 08/06/04 | 50.00      | B003 | BEAUTZ, JAN                   | 2102 | JUL BOARD MEETING    | 50.00      |
| 13125 | 08/06/04 | 50.00      | B006 | HINKLE, MICHELLE              | 2103 | JUL BOARD MEETING    | 50.00      |
| 13126 | 08/06/04 | 100.00     | B007 | KEOGH, MICHAEL                | 2104 | JUL BOARD MEETING    | 100.00     |
| 13127 | 08/06/04 | 100.00     | B010 | NORTON, DENNIS                | 2105 | JUL BOARD MEETING    | 100.00     |
| 13128 | 08/06/04 | 100.00     | B011 | REILLY, EMILY                 | 2106 | JUL BOARD MEETING    | 100.00     |
| 13129 | 08/06/04 | 100.00     | B012 | SPENCE, PAT                   | 2109 | JUL BOARD MEETING    | 100.00     |
| 13130 | 08/06/04 | 100.00     | B014 | CITY OF WATSONVILLE           | 2111 | JUL BOARD MEETING    | 100.00     |
| 13131 | 08/06/04 | 100.00     | B015 | ROTKIN, MIKE                  | 2107 | JUL BOARD MEETING    | 100.00     |
| 13132 | 08/06/04 | 50.00      | B016 | SKILLICORN, DALE              | 2108 | JUL BOARD MEETING    | 50.00      |
| 13133 | 08/06/04 | 100.00     | B017 | STONE, MARK                   | 2110 | JUL BOARD MEETING    | 100.00     |
| 13134 | 08/06/04 | 3,000.00   | E021 | HILTNER, THOMAS               | 2092 | MEDICAL EQUIPMENT    | 3,000.00   |
| 13135 | 08/06/04 | 34.00      | E048 | MARTINEZ, MARK                | 2093 | DMV FEES             | 34.00      |
| 13136 | 08/06/04 | 58.93      | E221 | DEAN, RONALD                  | 2094 | PARACRUZ MEETING     | 58.93      |
| 13137 | 08/06/04 | 10.00      | E258 | O'HAGIN, JUSTINA              | 2095 | VTT FEES             | 10.00      |
| 13138 | 08/06/04 | 10.00      | E304 | BRIDINGER, CHRIS              | 2096 | VTT FEES             | 10.00      |
| 13139 | 08/06/04 | 106.27     | E397 | GALLAGHER, MARGARET           | 2097 | TAPE DUPLICATION     | 106.27     |
| 13140 | 08/06/04 | 10.00      | E480 | PHILLIPS, THOMAS              | 2098 | VTT FEES             | 10.00      |

5-2.4

## CHECK JOURNAL DETAIL BY CHECK NUMBER

ALL CHECKS FOR COAST COMMERCIAL BANK

DATE: 08/01/04 THRU 08/31/04

| CHECK<br>NUMBER | CHECK<br>DATE | CHECK VENDOR<br>AMOUNT | VENDOR<br>NAME                               | VENDOR TRANS.<br>TYPE NUMBER | TRANSACTION<br>DESCRIPTION                                   | TRANSACTION COMMENT<br>AMOUNT |
|-----------------|---------------|------------------------|--|------------------------------|--|-------------------------------|
| 13141           | 08/06/04      | 10.00 E515             | GARBEZ, MANNY                                | 2099                         | VTT FEES   | 10.00                         |
| 13142           | 08/06/04      | 5,000.00 R424          | BEAMS, BEVERLY                               | 7<br>2100                    | SETTLEMENT CLAIM   | 5,000.00                      |
| 13143M          | 08/13/04      | 562.00 438             | COUNTY OF SANTA CRUZ<br>FEES PARACRUZ FACLTY | 2227                         | FEES PARACRUZ FACLTY   | 562.00 MANUAL                 |
| 13143P          | 08/13/04      | -562.00 438            | COUNTY OF SANTA CRUZ<br>VOID CHECK           | 2338                         | VOID CHECK   | -562.00 PRE-PAID              |
| 13144           | 08/20/04      | 1,077.95 001           | SBC  | 2123<br>2124<br>2125         | AUG PHONE/IT<br>AUG PHONE LINES<br>AUG PHONES                | 595.52<br>86.51<br>395.92     |
| 13145           | 08/20/04      | 46.57 001008           | SUNNYVALE FLUID SYSTEM                       | 2228                         | REV VEH PARTS  | 46.57                         |
| 13146           | 08/20/04      | 495.00 001040          | TERRYBERRY CO., LLC                          | 2126                         | EMPLOYEE INCENTIVE   | 495.00                        |
| 13147           | 08/20/04      | 1,609.94 001063        | NEW FLYER INDUSTRIES LIMITED                 | 2229                         | REV VEH PARTS 1500   | 1,609.94                      |
| 13148           | 08/20/04      | 152.63 001112          | BRINKS TROPHY SHOPPE                         | 7<br>2127                    | LOCAL MEETING EXP  | 152.63                        |
| 13149           | 08/20/04      | 786.00 001257          | DOMINICAN HOSPITAL OF S C                    | 2128                         | JUN DRUG TESTING   | 786.00                        |
| 13150           | 08/20/04      | 3,582.25 001492        | EVERGREEN OIL INC.                           | 2129<br>2130                 | HAZ WASTE DISPOSAL<br>HAZ WASTE DISPOSAL                     | 290.00<br>3,292.25            |
| 13151           | 08/20/04      | 939.10 001627          | NEW PIG CORPORATION                          | 2131                         | REPAIRS/MAINT 890  | 939.10                        |
| 13152           | 08/20/04      | 84.54 001976           | SPORTWORKS NORTHWEST, INC.                   | 2132                         | REV VEH PARTS 80   | 84.54                         |
| 13153           | 08/20/04      | 2,044.37 001A          | SBC/MCI                                      | 2133                         | JUL PHONES   | 2,044.37                      |
| 13154           | 08/20/04      | 120.98 002063          | COSTCO                                       | 2134<br>2135<br>2136         | PHOTO PROCESS/OPS<br>PHOTO PROCESS/OPS<br>PHOTO PROCESS/RISK | 53.52<br>34.68<br>32.78       |

5-2.5

|       |          |           |        |                              |      |                      |           |
|-------|----------|-----------|--------|------------------------------|------|----------------------|-----------|
| 13155 | 08/20/04 | 245.99    | 002094 | TRANSIT CARE, INC.           | 2137 | REV VEH PARTS        | 245.99    |
| 13156 | 08/20/04 | 146.71    | 002161 | APPLIED INDUSTRIAL TECH      | 2138 | REPAIRS/MAINTENANCE  | 146.71    |
| 13157 | 08/20/04 | 2,550.00  | 002287 | CALIFORNIA SERVICE EMPLOYEES | 2139 | AUG MEDICAL          | 2,550.00  |
| 13158 | 08/20/04 | 26,364.00 | 002295 | FIRST ALARM                  | 2140 | JUL SECURITY         | 26,364.00 |
| 13159 | 08/20/04 | 778.11    | 002412 | BORDEN DECAL                 | 2141 | REV VEH PARTS        | 778.11    |
| 13160 | 08/20/04 | 4,501.65  | 002627 | CDW GOVERNMENT, INC.         | 2230 | OFFICE SUPPLIES/IT   | 3,783.25  |
|       |          |           |        |                              | 2231 | OFFICE SUPPLIES/IT   | 526.55    |
|       |          |           |        |                              | 2240 | OFFICE SUPPLIES/OPS  | 191.85    |
| 13161 | 08/20/04 | 2,500.00  | 002634 | PITNEY BOWES PURCHASE POWER  | 2142 | POSTAGE FOR METER    | 2,500.00  |
| 13162 | 08/20/04 | 152.70    | 002639 | NEXTEL COMMUNICATIONS        | 2143 | 6/26-7/25 PHONES     | 152.70    |
| 13163 | 08/20/04 | 266.49    | 002643 | IOS CAPITAL                  | 2144 | 7/22-8/21 CANON RENT | 266.49    |
| 13164 | 08/20/04 | 104.50    | 002689 | B & B SMALL ENGINE           | 2145 | REPAIRS/MAINTENANCE  | 104.50    |
| 13165 | 08/20/04 | 1,362.01  | 002713 | SANTA CRUZ AUTO TECH, INC.   | 2146 | OUT REPAIR/#8029     | 1,121.11  |
|       |          |           |        |                              | 2147 | OUT REPAIR/#8027     | 240.90    |
| 13166 | 08/20/04 | 353.82    | 004    | NORTH BAY FORD LINC-MERCURY  | 2148 | OUT REPAIR OTHER VEH | 353.82    |
| 13168 | 08/20/04 | 22,448.83 | 009    | PACIFIC GAS & ELECTRIC       | 2149 | 7/1-7/30 RODRIGUEZ   | 1,338.41  |
|       |          |           |        |                              | 2150 | 7/1-7/30 HRVY WEST   | 35.72     |
|       |          |           |        |                              | 2151 | 7/1-7/30 GOLF CLUB   | 128.99    |
|       |          |           |        |                              | 2152 | 7/1-7/30 GOLF CLUB   | 1,912.37  |
|       |          |           |        |                              | 2153 | 7/1-7/30 RIVER ST    | 1,867.07  |
|       |          |           |        |                              | 2154 | 7/1-7/30 111 DUB     | 992.32    |
|       |          |           |        |                              | 2155 | 7/1-7/30 111 DUB     | 309.08    |
|       |          |           |        |                              | 2156 | 7/1-7/30 RIVER ST    | 102.09    |
|       |          |           |        |                              | 2157 | 7/1-7/30 370 ENC     | 2,940.95  |
|       |          |           |        |                              | 2158 | 7/1-7/30 370 ENC     | 53.52     |
|       |          |           |        |                              | 2159 | 7/1-7/30 RODRIGUEZ   | 21.51     |
|       |          |           |        |                              | 2160 | 7/8-8/4 PACIFIC      | 1,007.25  |
|       |          |           |        |                              | 2161 | 7/8-8/4 PACIFIC      | 591.55    |

5-2.6

CHECK JOURNAL DETAIL BY CHECK NUMBER

ALL CHECKS FOR COAST COMMERCIAL BANK

DATE: 08/01/04 THRU 08/31/04

| CHECK NUMBER | CHECK DATE | CHECK AMOUNT | VENDOR NAME                       | VENDOR TRANS. TYPE | TRANS. NUMBER | TRANSACTION DESCRIPTION | TRANSACTION AMOUNT | TRANSACTION COMMENT |
|--------------|------------|--------------|-----------------------------------|--------------------|---------------|-------------------------|--------------------|---------------------|
|              |            |              |                                   |                    | 2162          | 7/8-8/4 PACIFIC         | 120.64             |                     |
|              |            |              |                                   |                    | 2163          | 7/15-8/13 PAUL SWT      | 82.57              |                     |
|              |            |              |                                   |                    | 2164          | 7/13-8/11 KINGS VLG     | 560.41             |                     |
|              |            |              |                                   |                    | 2165          | 7/13-8/11 KINGS VLG     | 14.18              |                     |
|              |            |              |                                   |                    | 2166          | 7/1-7/30 CNG/E RVR      | 2,263.83           |                     |
|              |            |              |                                   |                    | 2167          | 7/6-7/31 CNG/G RVR      | 7,952.17           |                     |
|              |            |              |                                   |                    | 2168          | PM30261420              | 154.20             |                     |
| 13169        | 08/20/04   | 552.07       | 039 KINKO'S INC.                  |                    | 2169          | JUL PRINTING            | 552.07             |                     |
| 13170        | 08/20/04   | 145.85       | 040 LENZ ARTS, INC.               |                    | 2170          | FRAMES/EMP INC          | 145.85             |                     |
| 13171        | 08/20/04   | 2,333.76     | 041 MISSION UNIFORM               |                    | 2171          | JUL UNIFORMS/LAUNDRY    | 2,333.76           |                     |
| 13172        | 08/20/04   | 514.58       | 043 PALACE ART & OFFICE SUPPLY    |                    | 2232          | OFFICE SUPPLIES         | 514.58             |                     |
| 13173        | 08/20/04   | 194.12       | 061A REGISTER PAJARONIAN          |                    | 2172          | CLASSIFIED AD           | 194.12             |                     |
| 13174        | 08/20/04   | 10,872.30    | 085 DIXON & SON TIRE, INC.        |                    | 2173          | JUL TIRES/TUBES         | 10,872.30          |                     |
| 13175        | 08/20/04   | 192.90       | 115 SNAP-ON INDUSTRIAL            |                    | 2174          | EMP TOOL/IMPACT GUN     | 192.90             |                     |
| 13176        | 08/20/04   | 642.36       | 117 GILLIG CORPORATION            |                    | 2175          | REV VEH PARTS           | 642.36             |                     |
| 13177        | 08/20/04   | 94.64        | 130 CITY OF WATSONVILLE UTILITIES |                    | 2176          | 7/1-8/5 SAKATA          | 13.38              |                     |
|              |            |              |                                   |                    | 2177          | 7/1-8/5 RODRIGUEZ       | 9.46               |                     |
|              |            |              |                                   |                    | 2178          | 7/1-8/2 SAKATA          | 71.80              |                     |
| 13178        | 08/20/04   | 1,361.42     | 135 SANTA CRUZ AUTO PARTS, INC.   |                    | 2179          | REV VEH PARTS/SUPPLY    | 1,361.42           |                     |
| 13179        | 08/20/04   | 219.32       | 147 ZEE MEDICAL SERVICE           |                    | 2180          | SAFETY SUPPLIES         | 219.32             |                     |
| 13180        | 08/20/04   | 1,287.20     | 148 ZEP MANUFACTURING COMPANY     |                    | 2181          | CLEANING SUPPLIES       | 1,287.20           |                     |
| 13181        | 08/20/04   | 561.62       | 149 SANTA CRUZ SENTINEL           |                    | 2182          | JUL ADVERTISING         | 561.62             |                     |

5-2-7

|       |          |           |     |                                  |      |                      |          |
|-------|----------|-----------|-----|----------------------------------|------|----------------------|----------|
| 13182 | 08/20/04 | 21.96     | 166 | HOSE SHOP, THE                   | 2183 | REPAIRS/MAINTENANCE  | 21.96    |
| 13183 | 08/20/04 | 1,962.42  | 170 | TOWNSEND'S AUTO PARTS            | 2184 | REV VEH PARTS/SUPPLY | 1,962.42 |
| 13184 | 08/20/04 | 7.00      | 172 | CENTRAL WELDER'S SUPPLY, INC.    | 2185 | PARTS & SUPPLIES     | 7.00     |
| 13185 | 08/20/04 | 104.35    | 192 | ALWAYS UNDER PRESSURE            | 2186 | REPAIRS/MAINT WTRJET | 104.35   |
| 13186 | 08/20/04 | 2,672.94  | 221 | VEHICLE MAINTENANCE PROGRAM      | 2187 | REV VEH PARTS 2673   | 2,672.94 |
| 13187 | 08/20/04 | 60.00     | 271 | CARLSON, BRENT D., M.D., INC.    | 2188 | AUG DRUG TESTING     | 60.00    |
| 13188 | 08/20/04 | 2,863.56  | 282 | GRAINGER                         | 2189 | REPAIRS/MAINTENANCE  | 92.77    |
|       |          |           |     |                                  | 2190 | TORQUE WRENCH/FAC    | 111.80   |
|       |          |           |     |                                  | 2191 | QTY 2 TRUCK BOXES    | 1,046.34 |
|       |          |           |     |                                  | 2192 | CLEANING SUPPLIES    | 1,527.62 |
|       |          |           |     |                                  | 2193 | MOP BUCKET/FLT       | 85.03    |
| 13189 | 08/20/04 | 572.23    | 294 | ANDY'S AUTO SUPPLY               | 2194 | REV VEH PARTS/SUPPLY | 572.23   |
| 13190 | 08/20/04 | 100.00    | 307 | SANTA CRUZ CHAMBER OF COMMERCE   | 2195 | DUES 8/04-8/05       | 100.00   |
| 13191 | 08/20/04 | 153.00    | 367 | COMMUNITY TELEVISION OF          | 2196 | TV COVERAGE 7/23 MTG | 153.00   |
| 13192 | 08/20/04 | 17,218.95 | 378 | STEWART & STEVENSON              | 2197 | REV VEH PARTS        | 102.86   |
|       |          |           |     |                                  | 2198 | REV VEH PARTS        | 1,437.37 |
|       |          |           |     |                                  | 2199 | REV VEH PARTS        | 237.80   |
|       |          |           |     |                                  | 2200 | REV VEH PARTS        | 920.80   |
|       |          |           |     |                                  | 2201 | REBUILD TRANSMISSION | 5,023.26 |
|       |          |           |     |                                  | 2202 | REV VEH PARTS        | 1,884.66 |
|       |          |           |     |                                  | 2233 | REBUILD TRANSMISSION | 7,612.20 |
| 13193 | 08/20/04 | 396.57    | 389 | KEN'S AUTO PARTS, INC.           | 2203 | PARTS & SUPPLIES     | 396.57   |
| 13194 | 08/20/04 | 1,198.75  | 406 | MESITI-MILLER ENGINEERING, INC 7 | 2204 | PROF SVCS TO 7/25    | 1,198.75 |
| 13195 | 08/20/04 | 5,095.00  | 413 | COLUMBIA EQUIPMENT COMPANY INC   | 2205 | BUS SHLTR/MERCY 5095 | 5,095.00 |
| 13196 | 08/20/04 | 45.00     | 440 | RUNFOROFFICE.COM 7               | 2206 | JUL-SEP LOBBY REPORT | 45.00    |
| 13197 | 08/20/04 | 2,072.45  | 480 | DIESEL MARINE ELECTRIC, INC.     | 2207 | REV VEH PARTS        | 2,072.45 |
| 13198 | 08/20/04 | 321.00    | 481 | PIED PIPER EXTERMINATORS, INC.   | 2208 | JUL PEST CONTROL/    | 271.00   |
|       |          |           |     |                                  | 2209 | CHINA EXPRESS        | 50.00    |

S-2.8

CHECK JOURNAL DETAIL BY CHECK NUMBER  
 ALL CHECKS FOR COAST COMMERCIAL BANK

DATE: 08/01/04 THRU 08/31/04

| CHECK NUMBER | CHECK DATE | CHECK AMOUNT | VENDOR NAME                        | VENDOR TRANS. TYPE | TRANS. NUMBER | TRANSACTION DESCRIPTION | TRANSACTION AMOUNT | TRANSACTION COMMENT |
|--------------|------------|--------------|------------------------------------|--------------------|---------------|-------------------------|--------------------|---------------------|
| 13199        | 08/20/04   | 101.55       | 504 CUMMINS WEST, INC.             |                    | 2210          | REV VEH PARTS           | 101.55             |                     |
| 13200        | 08/20/04   | 191.92       | 510 ASCOM HASLER LEASING           |                    | 2211          | SEP EQUIP RENTAL        | 191.92             |                     |
| 13201        | 08/20/04   | 60.69        | 579 LAB SAFETY SUPPLY, INC.        |                    | 2212          | HAZ CHEM GUIDE 52       | 60.69              |                     |
| 13202        | 08/20/04   | 1,190.00     | 616 BROWN ARMSTRONG                |                    | 2213          | AUDIT SERVICES          | 1,190.00           |                     |
| 13203        | 08/20/04   | 563.00       | 629 HUGHES & ASSOCIATES            | 7                  | 2214          | INVESTIGATIVE SVCS      | 563.00             |                     |
| 13204        | 08/20/04   | 1,832.19     | 680 GOVPLACE                       |                    | 2215          | DISKEEPER LICENSES      | 1,832.19           |                     |
| 13205        | 08/20/04   | 150.00       | 708 CALIFORNIA HIGHWAY PATROL      |                    | 2216          | 9/7 CIVIL SUBPOENA 2    | 150.00             |                     |
| 13206        | 08/20/04   | 6,642.00     | 804 ORTHOPAEDIC HOSPITAL           | 7                  | 2239          | JUN PROF/TECH SVCS      | 6,642.00           |                     |
| 13207        | 08/20/04   | 133.20       | 819 MONEY SYSTEMS TECHNOLOGY, INC. |                    | 2217          | REV VEH PARTS 129       | 133.20             |                     |
| 13208        | 08/20/04   | 413.01       | 851 I.M.P.A.C. GOVERNMENT SERVICES |                    | 2220          | 4055019201230722        | 413.01             |                     |
| 13209        | 08/20/04   | 504.00       | 852 LAW OFFICES OF MARIE F. SANG   | 7                  | 2218          | WORKERS COMP CLAIMS     | 378.00             |                     |
|              |            |              |                                    |                    | 2219          | WORKERS COMP CLAIM      | 126.00             |                     |
| 13210        | 08/20/04   | 207.59       | 856 ANGI INTERNATIONAL LLC         |                    | 2221          | CNG IDLER BUSHING       | 207.59             |                     |
| 13211        | 08/20/04   | 1,589.24     | 872 YALE-PACIFIC, INC.             |                    | 2234          | OUT REPAIR FORKLIFTS    | 1,589.24           |                     |
| 13212        | 08/20/04   | 24.00        | 895 CARSON, DONALD W.              |                    | 2222          | REFUND PT COUPONS       | 24.00              |                     |
| 13213        | 08/20/04   | 289.73       | 914 CALTRONICS BUSINESS SYSTEMS    |                    | 2235          | OUT REPAIR EQUIP/FLT    | 12.26              |                     |
|              |            |              |                                    |                    | 2236          | TONER/DRUM FAX MACH     | 277.47             |                     |
| 13214        | 08/20/04   | 95.20        | 933 COUNTRY INN STS FRESNO NORTH   |                    | 2223          | CONFIRM #213H7QN        | 95.20              |                     |
| 13215        | 08/20/04   | 44.00        | E007 HARRIS, ANDREW                |                    | 2224          | DMV/VTT FEES            | 44.00              |                     |
| 13216        | 08/20/04   | 34.00        | E152 PENNA, LEONARDO               |                    | 2225          | DMV FEES                | 34.00              |                     |
| 13217        | 08/20/04   | 30.44        | M024 DOBBS, GLENN                  |                    | 2238          | MAR MEDICAL PREMIUM     | 30.44              |                     |
| 13218        | 08/20/04   | 250.00       | R425 HORTON, KERRY                 |                    | 2226          | SETTLEMENT CLAIM        | 250.00             |                     |

5-29



|                |                  |                             |           |                      |               |
|----------------|------------------|-----------------------------|-----------|----------------------|---------------|
| 13219M08/24/04 | 961.00 080       | STATE BOARD OF EQUALIZATION | 2333      | JUL USE TAX PREPAY   | 961.00 MANUAL |
|                |                  | JUL USE TAX PREPAY          |           |                      |               |
| 13220 08/27/04 | 1,407.05 001119  | MACERICH PARTNERSHIP LP     | 9000147   | CAPITOL MALL RENT    | 1,407.05      |
| 13221 08/27/04 | 31,581.00 002116 | HINSHAW, EDWARD & BARBARA   | 7 9000148 | 120 DUBOIS RENT      | 6,435.77      |
|                |                  |                             | 9000149   | 370 ENCINAL RENT     | 25,145.23     |
| 13222 08/27/04 | 10,794.22 002117 | IULIANO, NICK               | 9000150   | 111 DUBOIS RENT      | 10,794.22     |
| 13223 08/27/04 | 2,422.21 002610  | FREDERICK ELECTRONICS CORP. | 9000151   | 375 ENCINAL RENT     | 2,422.21      |
| 13224 08/27/04 | 900.00 840       | BOUCHARD, BRENT             | 9000152   | VERNON ST RENT       | 900.00        |
| 13225 08/27/04 | 72.14 M001       | HORTON, JOSEPH              | 9000153   | MED INS PREMIUM REIM | 72.14         |
| 13226 08/27/04 | 41.14 M002       | RACKLEY, EARL               | 9000154   | MED INS PREMIUM REIM | 41.14         |
| 13227 08/27/04 | 228.77 M003      | WYANT, JUDI                 | 9000155   | MED INS PREMIUM REIM | 228.77        |
| 13228 08/27/04 | 228.77 M005      | ROSS, EMERY                 | 9000156   | MED INS PREM REIMB   | 228.77        |
| 13229 08/27/04 | 596.40 M006      | VAN DER ZANDE, ED           | 9000157   | MED INS PREM REIMB   | 596.40        |
| 13230 08/27/04 | 489.54 M007      | BLAIR-ALWARD, GREGORY       | 9000158   | MED INS PREM REIMB   | 489.54        |
| 13231 08/27/04 | 816.40 M009      | FREEMAN, MARY               | 9000159   | MED INS PREM REIMB   | 816.40        |
| 13232 08/27/04 | 280.84 M010      | SHORT, SLOAN                | 9000160   | MED INS PREM REIMB   | 280.84        |
| 13233 08/27/04 | 41.14 M011       | LAWSON, LOIS                | 9000161   | MED INS PREM REIMB   | 41.14         |
| 13234 08/27/04 | 41.14 M012       | ROSE, JACK                  | 9000162   | MED INS PREM REIMB   | 41.14         |
| 13235 08/27/04 | 72.14 M013       | JAHNKE, EILEEN              | 9000163   | MED INS PREM REIMB   | 72.14         |
| 13236 08/27/04 | 41.14 M015       | HETH, KATHRYN               | 9000164   | MED INS PREM REIMB   | 41.14         |
| 13237 08/27/04 | 249.84 M016      | HICKLIN, DONALD KENT        | 9000165   | MED INS PREM REIMB   | 249.84        |
| 13238 08/27/04 | 20.07 M017       | PORTILLA, EARLENE           | 9000166   | MED INS PREM REIMB   | 20.07         |
| 13239 08/27/04 | 72.14 M019       | WILLIAMS, ROBERT            | 9000167   | MED INS PREM REIMB   | 72.14         |
| 13240 08/27/04 | 219.57 M022      | CAPELLA, KATHLEEN           | 9000168   | MED INS PREM REIMB   | 219.57        |
| 13241 08/27/04 | 8.94 M023        | CARLSON, WILLIAM            | 9000169   | MED INS PREM REIMB   | 8.94          |
| 13242 08/27/04 | 30.44 M024       | DOBBS, GLENN                | 9000170   | MED INS PREM REIMB   | 30.44         |
| 13243 08/27/04 | 35.19 M025       | ELIA, LARRY                 | 9000171   | MED INS PREM REIMB   | 35.19         |
| 13244 08/27/04 | 30.44 M028       | ORTEGA, MANUELA             | 9000172   | MED INS PREM REIMB   | 30.44         |

S-2.10

CHECK JOURNAL DETAIL BY CHECK NUMBER

ALL CHECKS FOR COAST COMMERCIAL BANK

DATE: 08/01/04 THRU 08/31/04

| CHECK NUMBER | CHECK DATE | CHECK VENDOR AMOUNT | VENDOR NAME                                 | VENDOR TRANS. TYPE NUMBER | TRANSACTION DESCRIPTION | TRANSACTION COMMENT |
|--------------|------------|---------------------|---|---------------------------|-------------------------|---------------------|
| 13245        | 08/27/04   | 39.94 M029          | REESE, CHARLES                              | 9000173                   | MED INS PREM REIMB      | 39.94               |
| 13246        | 08/27/04   | 11.34 M032          | TOWE, JANIE                                 | 9000174                   | MED INS PREM REIMB      | 11.34               |
| 13247M       | 08/30/04   | 19 195.08 001075    | SOQUEL III ASSOCIATES<br>SEP RENT & DEPOSIT | 2343                      | SEP RENT & DEPOSIT      | 19 195.08 MANUAL    |
| TOTAL        |            | 1 498 143 16        | COAST COMMERCIAL BANK                       |                           | TOTAL CHECKS            | 187 1 498 143 16    |

11.2-S

**Page 1 of the July Ridership Report will be  
presented for consideration at the  
September 24, 2004 Board Meeting.**

BUS OPERATOR LIFT TEST \*PULL-OUT\*

| VEHICLE CATEGORY        | TOTAL BUSES | AVG # DEAD IN GARAGE | AVG #AVAIL. FOR SERVICE | AVG # IN SERVICE | AVG # SPARE BUSES | AVG # LIFTS OPERATING | % LIFTS WORKING ON PULL-OUT BUSES |
|-------------------------|-------------|----------------------|-------------------------|------------------|-------------------|-----------------------|-----------------------------------|
| FLYER/HIGHWAY 17 - 40'  | 7           | 0                    | 7                       | 1                | 6                 | 1                     | 100%                              |
| FLYER/LOW FLOOR - 40'   | 12          | 1                    | 11                      | 5                | 6                 | 5                     | 100%                              |
| FLYER/LOW FLOOR - 35'   | 18          | 3                    | 15                      | 12               | 3                 | 12                    | 100%                              |
| FLYER/HIGH FLOOR - 35'  | 15          | 1                    | 14                      | 5                | 9                 | 5                     | 100%                              |
| GILLIG/SAMTRANS - 40'   | 10          | 2                    | 8                       | 8                | 0                 | 8                     | 100%                              |
| DIESEL CONVERSION - 35' | 15          | 3                    | 12                      | 12               | 0                 | 12                    | 100%                              |
| DIESEL CONVERSION - 40' | 14          | 4                    | 10                      | 9                | 1                 | 9                     | 100%                              |
| ORION/HIGHWAY 17 - 40'  | 11          | 1                    | 10                      | 8                | 2                 | 8                     | 100%                              |
| CHAMPION                | 4           | 1                    | 3                       | 0                | 3                 | 0                     | 100%                              |
| TROLLEY                 | 1           | 0                    | 1                       | 1                | 0                 | 1                     | 100%                              |
| CNG NEW FLYER - 40'     | 8           | 1                    | 7                       | 5                | 2                 | 5                     | 100%                              |

5-3.2

SANTA CRUZ METROPOLITAN TRANSIT DISTRICT

PASSENGER LIFT PROBLEMS

MONTH OF AUGUST 2004

| BUS #            | DATE             | DAY               | REASON  |
|------------------|------------------|-------------------|---|
| 3810LF<br>3807LF | 10-Aug<br>29-Aug | TUESDAY<br>SUNDAY | amp does not stow except manually<br>us still moved forward with front door open & kneel down |

- F New Flyer
- G Gillig
- C Champion
- LF Low Floor Flyer
- GM GMC
- CG CNG
- CN SR855 & SR854
- OR Orion/Hwy 17

Note: Lift operating problems that cause delays of less than 30 minutes.

5-3.3

Service Interruption Summary Report  
Lift Problems  
08/01/2004 to 08/31/2004

| AM Peak<br>Hour/Mile | Midday<br>Hour/Mile | PM Peak<br>Hour/Mile | Other<br>Hour/Mile | Weekday<br>Hour/Mile | Saturday<br>Hour/Mile | Sunday<br>Hour/Mile |
|----------------------|---------------------|----------------------|--------------------|----------------------|-----------------------|---------------------|
| 00:00/0              | 00:00/00.00         | 00:00/00.00          | 0:00               | 00:00/00.00          | 00:00/0               | 00:00/0             |

5-3.4

# GOVERNMENT TORT CLAIM

## RECOMMENDED ACTION

TO: Board of Directors

FROM: District Counsel

RE: Claim of: Saavedra, Jose Received: 8/3 1/04 Claim #: 04-0016  
Date of Incident: 7/15/04 Occurrence Report No.: SC 07-04-09

In regard to the above-referenced Claim, this is to recommend that the Board of Directors take the following action:

- 1. Reject the claim entirely.
- 2. Deny the application to file a late claim.
- 3. Grant the application to file a late claim.
- 4. Reject the claim as untimely filed.
- 5. Reject the claim as insufficient.
- 6. Allow the claim in full.
- 7. Allow the claim in part, in the amount of \$\_\_\_\_\_ and reject the balance.

By Margaret Gallagher  
Margaret Gallagher er  
DISTRICT COUNSEL

Date: 8/02/04

I, Cindi Thomas, do hereby attest that the above Claim was duly presented to and the recommendations were approved by the Santa Cruz Metropolitan Transit District's Board of Directors at the meeting of.

By \_\_\_\_\_  
Cindi Thomas  
RECORDING SECRETARY

Date: \_\_\_\_\_

MG/mm  
Attachment(s)

CLAIM AGAINST THE SANTA CRUZ METROPOLITAN TRANSIT DISTRICT

(Pursuant to Section 91 et Seq., Government Code)

Claim # 04-0016

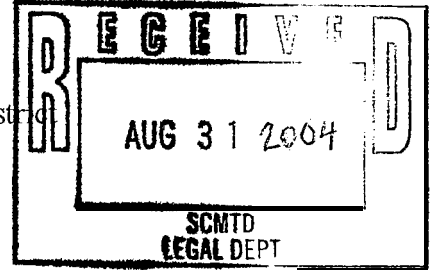

TO: BOARD OF DIRECTORS, Santa Cruz Metropolitan Transit District

ATTN: Secretary to the Board of Directors
370 Encinal Street, Suite 100
Santa Cruz, CA 95060

1. Claimant's Name: Jose Saavedra

Claimant's Address/Post Office Box: 150-B-quiet meadow DRIVE
WATSONVILLE, CALIF 95076

Claimant's Phone Number: 831-729-6197

2. Address to which notices are to be sent: SAME AS ABOVE

3. Occurrence: accident inside the BUS/TIRE IN THE BACK OF THE
BUS - OUT causing an accident

Date: Times/04 1: PM Place: HWY 1

Circumstances of occurrence or transaction giving rise to claim: The BUS
EXPRESS W68 OR W69 WAS DRIVING SOUTH
ON HWY 1 FROM SANTA CRUZ TO WATSONVILLE
When accident occurred during accident
LEFT LOWER BACK WAS INJURED - I WAS TAKEN TO Watsonville Hos

4. General description of indebtedness, obligation, injury, damage, or loss incurred so far as
is known: Ambulance BHO - Bill FROM Watsonville COM- spinal
PAIN AND SUFFERING AND MY LOWER BACK INJURY
LOSS OF TIME AND WAGES FROM WORK DO TO
The accident

5. Name or names of public employees or employees causing injury, damage, or loss, if
known: I DON'T KNOW THE DRIVER OF THE BUS BUT IT
was the express 68W OR 69W FROM SANTA CRUZ TO Watson

6. Amount claimed now ..... \$ 6,000.00
Estimated amount of future loss, if known ..... \$ 15,000.00
TOTAL ..... \$ 21,000.00

7. Basis of above computations: IMMEDIATE medical bills
FUTURE medical bills BECAUSE OF BACK INJURY TO SPINE
Loss of wages / FROM WORK AND FUTURE PAIN AND SUFFERING
Jose Saavedra 9/15/04

CLAIMANT'S SIGNATURE (or Company
Representative or Parent of Minor Claimant)

DATE

Note: Claim must be presented to the Secretary to the Board of Directors, Santa Cruz
Metropolitan Transit District



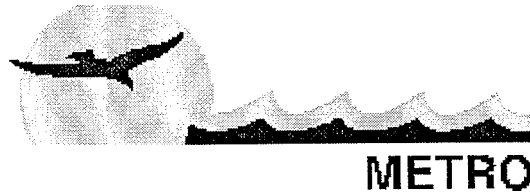

## **Agenda**

### **Metro Advisory Committee**

6:00 pm  
September 22, 2004  
920 Pacific Avenue  
Santa Cruz, California

- I. Roll Call
- II. Agenda Additions/ Deletions
- III. Oral/Written Communication
- IV. Consideration of Minutes of August 18, 2004 MAC Meeting
- V. Election of MAC Vice Chair
- VI. Consideration of Recommendation Regarding Process for Board Removal of Advisory Committee Members.
- VII. Discussion of Bikes on Buses Accessibility.
- VIII. Consideration of the Actions Taken by the California Transportation Commission on August 5, 2004 and the Impact on MetroBase Funding.
- IX. Discussion of State of California General Fund Debt to Transportation Fund.
- X. Receive Information Regarding Comparability of METRO Labor Costs to Other Bay Area Transit Systems.
- XI. Review and Discussion of the State Transportation Improvement Program (STIP) 2004/2009 and the SCCRTC Expenditure Plan being submitted to the Voters.
- XII. Consideration of Board Rules of Order
- XIII. Consideration of Measure J for the November Election
- XIV. Discussion of Surfboards on Buses

- XV. Communications to METRO General Manager.
- XVI. Communications to METRO Board of Directors.
- XVII. Items for Next Meeting Agenda.
- XVIII. Adjournment

Next Meeting: Wednesday October 20, 2004 @ 6:00 pm  
Santa Cruz Metro Center Conference Room  
Santa Cruz Metro Center

**SANTA CRUZ METROPOLITAN TRANSIT DISTRICT**

**Minutes- METRO Advisory Committee (MAC)**

**July 21, 2004**

---

A Regular Meeting of the METRO Advisory Committee (MAC) met on Wednesday, July 21, 2004 at the METRO Center Conference Room, 920 Pacific Avenue, Santa Cruz, CA.

At 6:10 p.m. METRO General Manager, Les White, announced that since MAC Chair Kanoa Dynek was absent and there was a quorum, the committee could select a temporary Chair for today's meeting.

**ACTION: MOTION: JEFF LE BLANC SECOND: NORM HAGEN**

**MAC ELECTS PAUL MARCELIN-SAMPSON TO ACT AS TEMPORARY CHAIR FOR TODAY'S MAC MEETING**

**Motion passed unanimously with Kanoa Dynek, Matthew Melzer and Stuart Rosenstein being absent.**

**1. ROLL CALL:**

**MEMBERS PRESENT**

Dan Alper  
Norm Hagen  
Jeff Le Blanc  
Paul Marcelin-Sampson  
James Sheldon  
Lesley Wright  
Robert Yount

**MEMBERS ABSENT**

Kanoa Dynek, Chair  
Matthew Melzer  
Stuart Rosenstein

**VISITORS PRESENT**

None

**STAFF PRESENT**

Bryant Baehr, Operations Manager  
Les White, General Manager

**2. AGENDA ADDITIONS/DELETIONS**

None.

**3. ORAL/WRITTEN COMMUNICATIONS**

Oral: Les White reported that Stuart Rosenstein had contacted Staff to say he would be absent from today's meeting.

Written: Norm Hagen distributed 2 handouts, which are attached as part of these minutes. The first one, dated 7/19/04, announcing his resignation from the Paratransit Coordination Task

**5-5.3**

Force; and the second, dated 7/21/04 rescinding his verbal resignation from MAC at the June 16, 2004 MAC meeting.

Oral: Robert Yount announced that he would like MAC to follow the same procedures for conducting MAC meetings that the METRO's Board of Directors use for Board meetings. Temporary Chair, Paul Marcelin-Sampson, suggested this be addressed under Item #1 1 on today's agenda.

Oral: Paul Marcelin-Sampson reported that Stuart Rosenstein had joined himself and the Metro Riders Union at the Watsonville Transit Center (WTC) on June 17, 2004 handing out fliers announcing the Service Reductions Public Hearings that were held in Watsonville. Paul added that James Sheldon offered to participate in future Riders Union outreach activities.

#### **4. CONSIDERATION OF MINUTES OF JUNE 16, 2004 MAC MEETING**

Norm Hagen proposed deleting the reference to his resignation on Page 5 of the June 16, 2004 MAC minutes because he had not intended to resign and had spoken to Director Tavantzis, who appointed him to MAC, and rescinded his resignation the next day. (Refer to Mr. Hagen's letter, attached to these minutes).

The committee discussed different ways to go about this and agreed that the minutes should reflect accurately what happened to preserve their integrity. James Sheldon suggested adding a footnote to the June 16<sup>th</sup> minutes explaining that Mr. Hagen rescinded his resignation the next day. The file copy of these minutes were changed to reflect the following: \*On June 17, 2004, Norm Hagen rescinded his resignation from MAC was added at the bottom of page 5.

**ACTION: MOTION: JAMES SHELDON SECOND: ROBERT YOUNT**

**ACCEPT AND FILE MINUTES OF THE JUNE 16, 2004 MAC MEETING AS AMENDED.**

**Motion passed with Norm Hagen abstaining and Kanoa Dynek, Matthew Melzer and Stuart Rosenstein being absent.**

#### **5. CONSIDERATION OF RECOMMENDATION REGARDING THE DEVELOPMENT OF A PROCESS FOR BOARD REMOVAL OF ADVISORY COMMITTEE MEMBERS**

Les White explained that the Bonnie Morr, Chair of the UTU Committee of Adjustment had requested that the Board address this issue. Currently, the only way to remove a MAC member is due to absences.

The Committee expressed that this request is inappropriate and stems from the Committee of Adjustment's belief that some of MAC's views may be inconsistent with UTU's views. Discussion turned to the fact that MAC members were appointed by the Board and need the ability to express themselves, and it is expected that their views will not always be consistent with the Board's, METRO's, UTU's, etc.

**ACTION: MOTION: PAUL MARCELIN-SAMPSON SECOND: JEFF LE BLANC**

**5.54**

**MAC RECOMMENDS THAT THE BOARD OF DIRECTORS REFRAIN FROM DEVELOPING OR IMPLEMENTING A PROCESS FOR THE REMOVAL OF BOARD APPOINTEES TO BOARDS AND COMMITTEES FOR REASONS OTHER THAN ABSENCE**

**Motion passed with Kanoa Dynek, Matthew Melzer and Stuart Rosenstein being absent.**

**6. CONSIDERATION OF LETTER REGARDING UNMET TRANSIT NEEDS**

Les White explained that part of METRO's funding comes from a ¼ cent sales tax which is collected by the State and allocated to the Santa Cruz County Regional Transportation Commission (SCCRTC). The SCCRTC receives these funds pursuant to the Transportation Development Act (TDA). One of the requirements of the TDA is that the SCCRTC make an annual finding with respect to unmet transit needs.

The Board will hold a Public Hearing at the Board meeting on Friday, July 23, 2004 to consider what unmet fixed route and ParaCruz needs should be transmitted to the SCCRTC for inclusion in the unmet needs finding.

After discussion, the following motion was made adding several unique additional items to the list, in no particular order, and not duplicating those items already on or being added to the list by other committees:

**ACTION: MOTION: NORM HAGEN SECOND: LESLEY WRIGHT**

**MAC RECOMMENDS THAT THE BOARD OF DIRECTORS INCLUDE THE FOLLOWING ADDITIONS TO THE LIST OF UNMET TRANSIT NEEDS TO BE SUBMITTED TO THE SANTA CRUZ COUNTY REGIONAL TRANSPORTATION COMMISSION FOR CONSIDERATION.**

- **Improved frequencies and wider span of service on the Highway 17/Amtrak service.**
- **Implementation of 30-minute peak hour frequencies or better on all collector and arterial routes.**
- **Better connection of UCSC main campus to Long Marine Lab and Westside offices (old Texas Instruments Bldg).**
- **Service to new Watsonville High School.**
- **Service from Santa Cruz County to Los Gatos.**
- **Implementation of Improved East/West Express service to UCSC and Cabrillo College.**
- **Express service from the San Lorenzo Valley to UCSC and Cabrillo College.**
- **Direct bi-directional service in the Watsonville service area.**
- **"Bona Fide" express service connecting the four transit centers in Santa Cruz County together.**
- **Direct service between Santa Cruz and Monterey.**
- **Service to Independence Square in Watsonville.**
- **Service to the Santa Cruz County Fairgrounds in Watsonville.**

- **Service from the UC Inn to UCSC.**
- **Expanded evening and late night service on major fixed routes to improve service accessibility.**
- **Expanded service to UCSC to eliminate “pass-bys”.**
- **Expand bicycle capacity and access on the fixed route system.**
- **Reduce the cash fare while preserving the pass charges so that the average fare using a pass is a higher percentage of the cash fare than currently exists.**
- **Establish a means tested low income fare.**

**Motion passed with Kanoa Dynek, Matthew Melzer and Stuart Rosenstein being absent.**

**ITEM #8 WAS TAKEN OUT OF ORDER AT THIS TIME**

**8. CONSIDERATION OF TRANSMITTING A LETTER OF SUPPORT FOR METROBASE FUNDING TO THE CALIFORNIA TRANSPORTATION COMMISSION.**

Les White reported that the California Transportation Commission (CTC) received the Staff Recommendations for the funding of projects for the State Transportation Improvement Program (STIP) for the time period 2005/2009. The Santa Cruz County Regional Transportation Commission (SCCRTC) included a reprogramming of \$7.8 million of previously programmed funds for the MetroBase Project.

The CTC will consider the 2005/2009 STIP Projects in August 2004. In anticipation of that meeting, METRO and the SCCRTC are soliciting Members of the Legislature, organizations, and committees to write letters to the CTC supporting the restoration of the MetroBase funding by the July 23, 2004 deadline.

Staff recommends that MAC authorize the Chair of MAC to submit a MetroBase funding support letter to the CTC.

**ACTION: MOTION: JEFF LE BLANC SECOND: DAN ALPER**

**MAC AUTHORIZES THE MAC CHAIR TO SUBMIT A METROBASE FUNDING SUPPORT LETTER TO THE CALIFORNIA TRANSPORTATION COMMISSION, MAKING A SPECIAL ALLOWANCE TO ALLOW PAUL MARCELIN-SAMPSON TO SIGN THE LETTER AS ACTING CHAIR.**

Staff will insert a brief statement in the letter explaining what MAC is.

**Motion passed with Kanoa Dynek, Matthew Melzer and Stuart Rosenstein being absent.**

**7. REVIEW OF TRANSITION OF PARACRUZ OPERATIONS**

Bryant Baehr reported that the Board had authorized Staff to bring ParaCruz service in-house effective November 1, 2004. Staff is currently looking for property to lease for a ParaCruz facility, which is not part of the current MetroBase project.

The District owns 29 ParaCruz vehicles, with 3 more on the way. Mr. Baehr explained that at least 29 support staff is needed. Current Lift Line employees will be considered first, then those

**5-5.6**

that have been laid off before hiring from the outside. The District is currently recruiting internally for the ParaCruz Superintendent and the Route Scheduling Coordinator.

Mr. Baehr reported that there will be outreach to customers and other providers including a personal letter from Steve Paulson, a progress report, and new phone number stickers. Paul Marcelin-Sampson suggested magnets.

Bryant said he could give a status report on this item each month going forward.

**9. COMMUNICATIONS TO METRO GENERAL MANAGER**

Les White urged future communications from MAC be more in line with the big picture, rather than the details.

**10. COMMUNICATIONS TO MERTRO BOARD OF DIRECTORS**

**ACTION: MOTION: JEFF LE BLANC SECOND: DAN ALPER**

**MAC RECOMMENDS THAT THE MEMBERS OF THE BOARD OF DIRECTORS WHO ALSO SERVE ON THE SANTA CRUZ COUNTY REGIONAL TRANSPORTATION COMMISSION (SCCRTC) TAKE A LEADERSHIP ROLE IN FINDING FUNDING FOR THE \$7.8 MILLION COMMITTED TO THE METROBASE PROJECT IN THE REGIONAL TRANSPORTATION IMPROVEMENT PROGRAM (RTIP) WHICH HAS NOT BEEN RECOMMENDED FOR APPROVAL BY THE STAFF OF THE CALIFORNIA TRANSPORTATION COMMISSION (CTC).**

**Motion passed with Kanoa Dynek, Matthew Melzer and Stuart Rosenstein being absent.**

**11. ITEMS FOR NEXT MEETING AGENDA**

- Procedure to conduct MAC meetings
- Recommend a permanent replacement MAC representative for the Paratransit Coordination Task Force (PCTF).

Lesley Wright volunteered to attend the August PCTF meeting as a temporary MAC representative.

**THE FOLLOWING MOTION WAS ADDED TO ITEM #10**

**10. COMMUNICATIONS TO MERTRO BOARD OF DIRECTORS**

**ACTION: MOTION: NORM HAGEN SECOND: JAMES SHELDON**

**MAC RECOMMENDS THAT THE BOARD APPOINT LESLEY WRIGHT AS TEMPORARY MAC REPRESENTATIVE TO ATTEND THE AUGUST 2004 PARATRANSIT COORDINATION TASK FORCE MEETING.**

**Motion passed with Kanoa Dynek, Matthew Melzer and Stuart Rosenstein being absent.**

**CHAIR RETURNED TO ITEM #11**

**11. ITEMS FOR NEXT MEETING AGENDA**

- Discussion of Macro Issues
- General Fund Bailout
- METRO Labor Costs

**ADJOURN**

There being no further business, Acting Chair Paul Marcelin-Sampson adjourned the meeting at 8:00 p.m.

Respectfully submitted,



Cindi Thomas  
Administrative Secretary



07-19-04

Metropolitan Advisory Committee  
ParaCruz Advisory Taskforce  
Santa Cruz Metropolitan Transit District

I find it necessary to withdraw from this Taskforce due to the length of its time – three hours – and the particular day, Wednesday, the same day on which the MAC meeting is held. My health cannot endure the 8-9 hours, counting bus trips from Watsonville, for these meetings. Therefore, I will no longer be attending the task force meetings, and MAC will have to select a replacement for me, however I will maintain my appointment to MAC by Ms. Tavantsis.

Sincerely

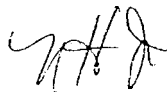

Norm Hagen Jr.

5-5.9

07-21-04

To: MAC Members

Deletion of minutes of 06-16 minutes pg. 5 line 6 "gave his verbal resignation"  
Insofar as I spoke first to Ms Tavantzsis, who appointed me, the next morning,  
and rescinded the resignation. I also spoke with together with Paul Marcelin-  
Sampson, Stuart Rosenstein, and Ian McFadden and our Vice-Chair that day  
saying that I really did not want to resign but rather spoke inappropriately due to  
an exhausting 8-9 hour long day. \* Refer to reason

\*Resignation from Task Force

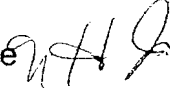
A handwritten signature in black ink, appearing to be "W.H.S.", written over the text "\*Resignation from Task Force".

5-5.10

# SANTA CRUZ METROPOLITAN TRANSIT DISTRICT

**DATE:** September 24, 2004

**TO:** Board of Directors

**FROM:** Steve Paulson, Paratransit Administrator

**SUBJECT: METRO PARACRUZ PROGRAM STATUS MONTHLY UPDATE**

## I. RECOMMENDED ACTION

**This report is for information only- no action requested**

## II. SUMMARY OF ISSUES

- The Board receives monthly reports on the status of the federally mandated ADA complementary paratransit program
- Operating Statistics reported are for the month of June 2004
- Cost reflects hourly rate increased by 4% over previous fiscal year.
- Revenue and subsidy figures reflect impact of July 2003 fare increase.
- Eligibility/certification statistics reported are through August 31, 2004

## III. DISCUSSION

### Operating Statistics for June 2004

|                 | <b>This June</b>    | <b>Last June</b>    | <b>%<br/>Change</b> | <b>FY04</b>         | <b>Last FY03</b>    | <b>%<br/>Change</b> |
|-----------------|---------------------|---------------------|---------------------|---------------------|---------------------|---------------------|
| Cost            | \$165,992.02        | \$170,618.48        | -2.71%              | \$2,394,965.10      | \$2,565,293.28      | -6.64%              |
| Revenue         | \$21,657*           | \$16,032*           | +35.09 %            | \$270,729*          | \$206,876           | +30.87 %            |
| Subsidy         | \$144,335.02        | \$154,586.48        | -6.63%              | \$2,124,236.10      | \$2,358,417.28      | -9.93 %             |
| Rides performed | <b>7301</b>         | <b>8196</b>         | <b>-10.92 %</b>     | <b>91,704</b>       | <b>105,989</b>      | <b>-13.48 %</b>     |
| Cost/ Ride      | \$22.74             | \$20.82             | 9.21%               | \$26.12             | \$24.20             | +7.90%              |
| Productivity    | 1.90 rides per hour | 1.96 rides per hour |                     | 2.01 rides per hour | 1.94 rides per hour |                     |

\* Revenue does not equal \$3.00/ride because no revenue is generated by rides to and from certification interviews and appeals.

5-7.1

**Performance Measures**

|   | July    | Aug   | Sept    | Oct     | Nov   | Dec     | Jan   | Feb     | Mar     | Apr    | May    | June   | FYTD     |
|---|---------|-------|---------|---------|-------|---------|-------|---------|---------|--------|--------|--------|----------|
| <b>Rides</b>  | 7,887   | 7,402 | 7,157   | 8,709   | 7,471 | 7,168   | 6,983 | 6,787   | 8,280   | 7,938  | 7,621  | 7,301  | 91,704   |
| <b>late pick ups<br/>(more than 20<br/>minutes)</b>                   | 452     | 379   | 537     | 878     | 498   | 388     | 297   | 324     | 487     | 436    | 403    | 288    | 5,367    |
| <b>% late</b>   | 5.73%   | 5.12% | 7.58%   | 10.08%  | 6.67% | 5.41%   | 4.25% | 4.77%   | 5.88%   | 5.49%  | 5.29%  | 3.94%  | 5.85%    |
| <b>Picked up too<br/>early<br/>(more than 10<br/>minutes)</b>         | 252     | 271   | 327     | 164     | 134   | 132     | 92    | 75      | 65      | 93     | 61     | 101    | 1,767    |
| <b>Total rides not<br/>"on time"</b>                                  | 704     | 650   | 864     | 1,042   | 632   | 520     | 389   | 399     | 552     | 529    | 464    | 389    | 7,134    |
| <b>% "on time"</b>  | 91.1%   | 91.2% | 92.4%   | 88.0%   | 91.5% | 92.7%   | 94.4% | 94.1%   | 93.33%  | 93.34% | 93.91% | 94.67% | 92.22%   |
| <b>missed trips</b>   | 2       | 5     | 5       | 9       | 0     | 2       | 3     | 3       | 3       | 4      | 1      | 1      | 38       |
| <b>Excessively late<br/>scheduled<br/>(more than 60<br/>minutes)</b>  | 14      | 4     | 15      | 38      | 9     | 12      | 8     | 3       | 10      | 9      | 9      | 5      | 136      |
| <b>Excessively<br/>late will call<br/>(more than 100<br/>minutes)</b> | 4       | 3     | 11      | 14      | 5     |         | 13    | 4       | 10      | 3      | 5      | 8      | 71       |
| <b>total violation<br/>w/ \$50 penalty</b>                            | 20      | 12    | 31      | 61      | 14    | 15      | 14    | 10      | 23      | 16     | 15     | 14     | 245      |
| <b>Total violation<br/>w/\$100 penalty</b>                            | 0       | 0     | 0       | 0       | 0     | 9       | 0     | 9       | 12      | 0      | 0      | 0      | 30       |
| <b>Liquidated<br/>damages</b>   | \$1,000 | \$600 | \$1,500 | \$3,050 | \$700 | \$1,650 | \$700 | \$1,400 | \$2,351 | \$800  | \$750  | \$700  | \$15,250 |

**Eligibility Certification/ Recertification**

The initial recertification process has been completed. There are no eligibility appeals pending.

During the month of August 2004, there was a net increase of 45 riders eligible for service.

**IV. FINANCIAL CONSIDERATIONS**

none

**V. ATTACHMENTS**

- Attachment A:** METRO ParaCruz Rides by Month
- Attachment B:** METRO ParaCruz Cost by Month
- Attachment C:** Recertification and New Applicant Eligibility Determinations
- Attachment D:** METRO ParaCruz Registrants by Month

5-7.2

### METRO ParaCruz Rides by Month

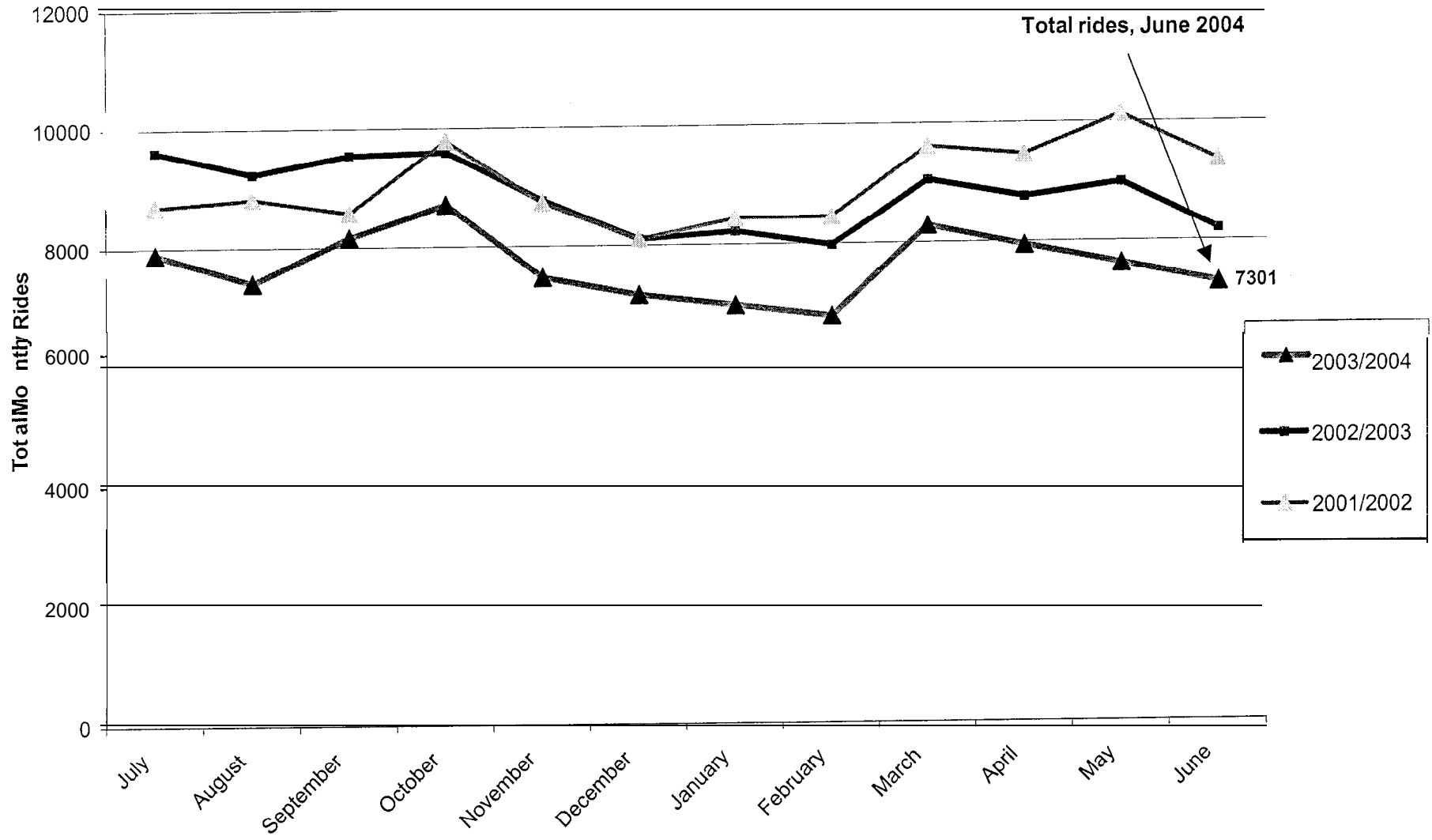

5-7.a1

5-7.61

### METRO ParaCruz Cost By Month

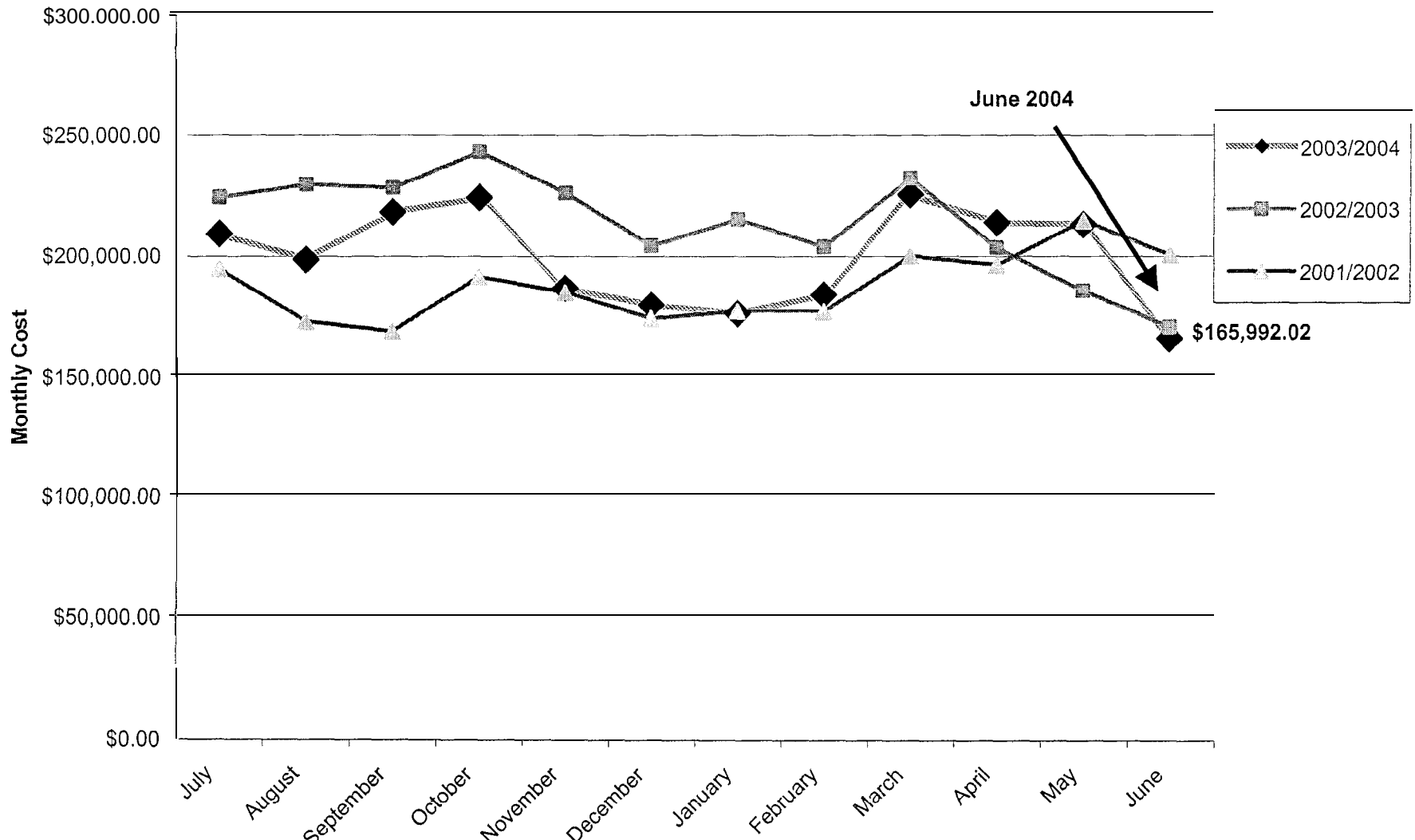

Attachment **B**

**METRO ParaCruz Eligibility Determinations -  
Aug 1 02 through Aug 30 04**

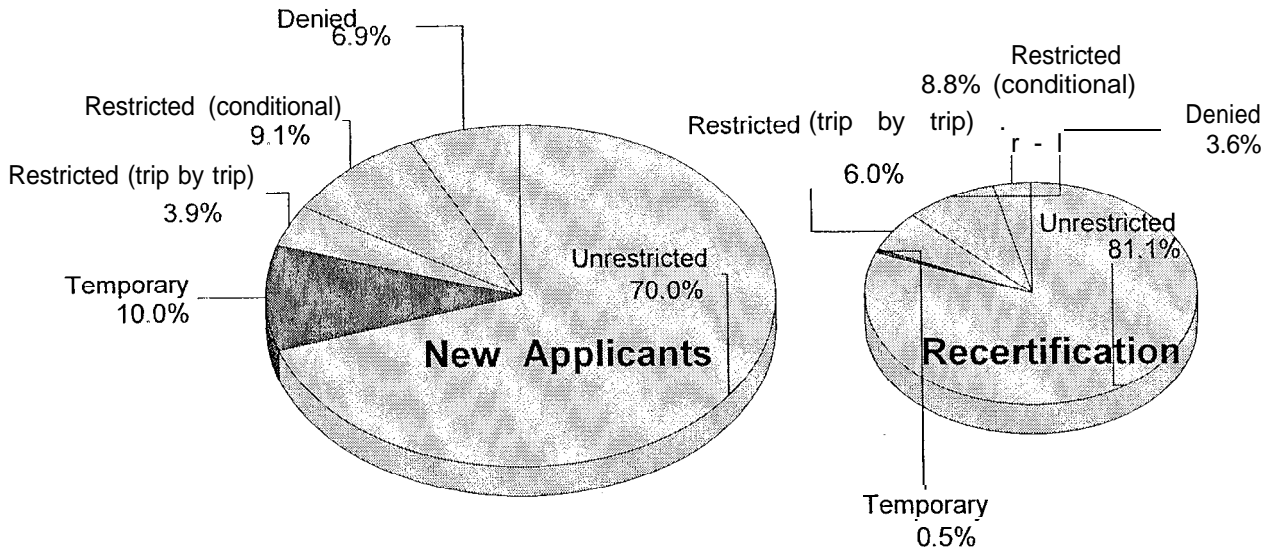

**New Applicants**

|                           |             |
|---------------------------|-------------|
| Unrestricted              | 1514        |
| Temporary                 | 216         |
| Restricted (trip by trip) | 85          |
| Restricted (conditional)  | 197         |
| Denied                    | 150         |
| <b>Group Total:</b>       | <b>2162</b> |

**Recertification**

|                           |             |
|---------------------------|-------------|
| Unrestricted              | 1140        |
| Temporary                 | 7           |
| Restricted (trip by trip) | 84          |
| Restricted (conditional)  | 124         |
| Denied                    | 51          |
| <b>Group Total:</b>       | <b>1406</b> |

**Grand Total:** 3568

# METRO ParaCruz Registrants

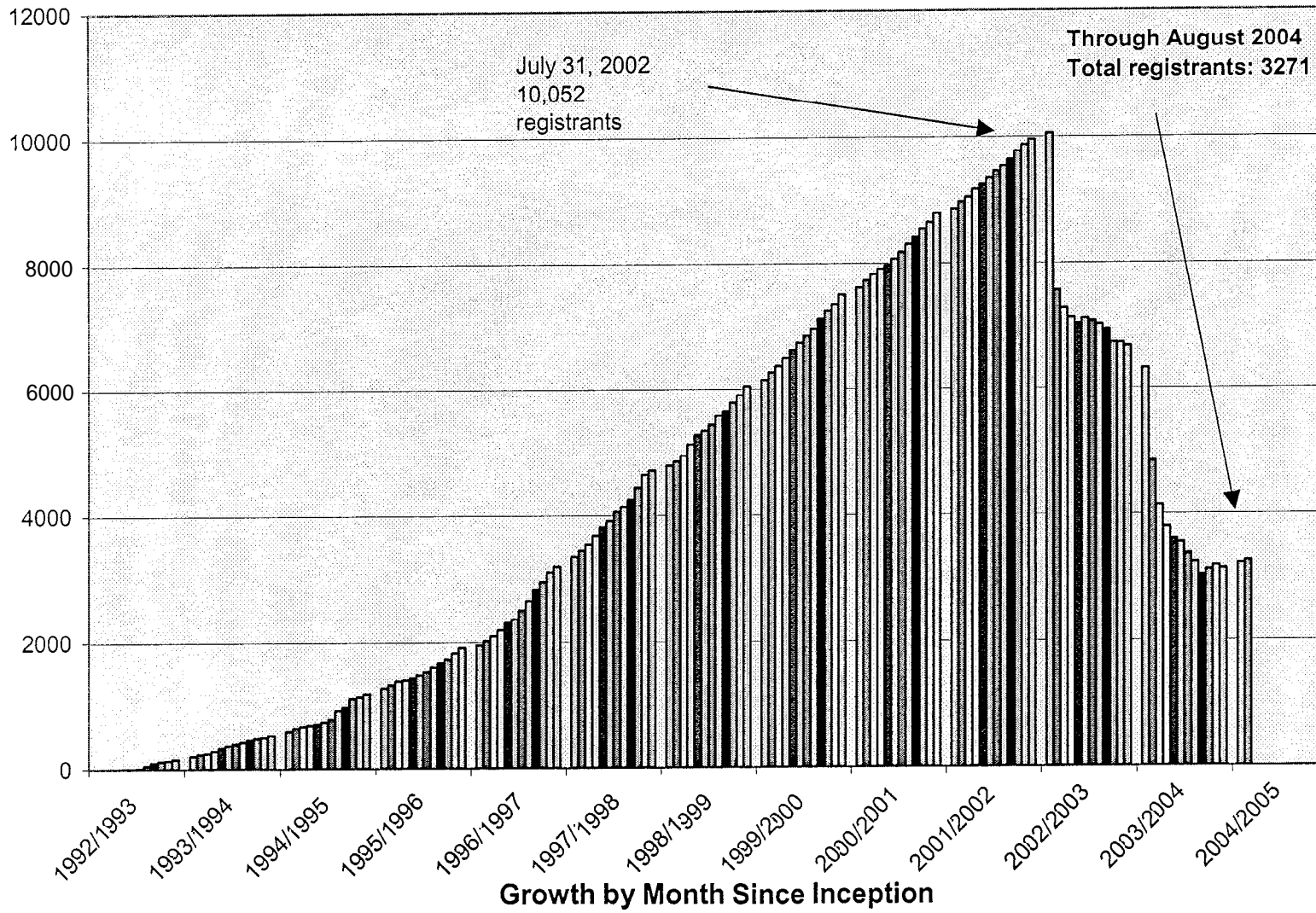

5-7.01



# SANTA CRUZ METROPOLITAN TRANSIT DISTRICT

**DATE:** September 24, 2004  
**TO:** Board of Directors  
**FROM:** Bryant J. Baehr, Manager of Operations  
**SUBJECT:** UNIVERSITY OF CALIFORNIA - SANTA CRUZ SERVICE UPDATE

## I. RECOMMENDED ACTION

**This report is for information purposes only. No action is required**

## II. SUMMARY OF ISSUES

- Student trips for July 2004 decreased by (4.4%) versus July 2003. Year to date student billable trips have decreased by (4.4%).
- Faculty / staff trips for July 2004 decreased by (3.6%) versus July 2003. Year to date faculty / staff billable trips have decreased by (3.6%).
- Revenue received from UCSC for July 2004 was \$38,545 versus \$33,842 for July 2003 an increase of 13.9%.

|           | Faculty/Staff<br>Ridership | Student<br>Ridership | Monthly<br>Increase -<br>(Decrease)<br>Student | Monthly<br>Increase -<br>(Decrease)<br>Faculty-Staff |
|-----------|----------------------------|----------------------|--|--|
| This Year | 16,549                     | 28,369               | (4.4)  | (3.6)  |
| Last Year | 17,174                     | 29,689               |  |  |

## III. DISCUSSION

September 25, 2003 and ended on June 10, 2004. A summary of the results for July 2004 is:

- Student billable trips for the month of July 2004 were 28,369 vs. 29,689 for July 2003 a decrease of (4.4%).
- Faculty / staff billable trips for the month of July 2004 were 16,549 vs. 17,174 for July 2003 a decrease of (3.6%).
- Year to date Student billable trips decreased by (4.4%) and faculty / staff billable trips decreased by (3.6%).
- Revenue for July 2004 was \$38,545 versus \$33,842 for July 2003.

5-9.1

### UCSC Student Billable Trips

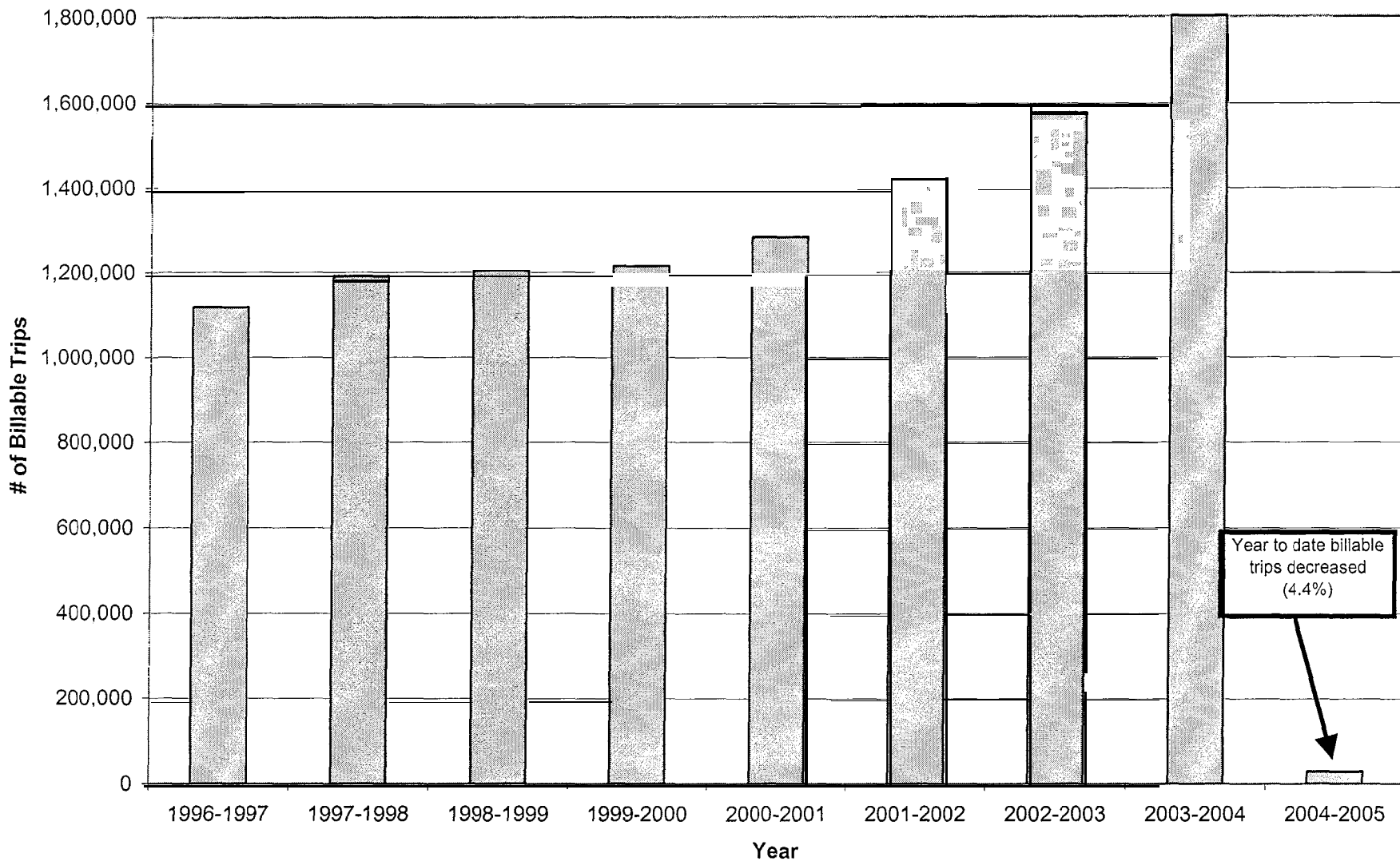

5-9.91

### UCSC Faculty / Staff Billable Trips

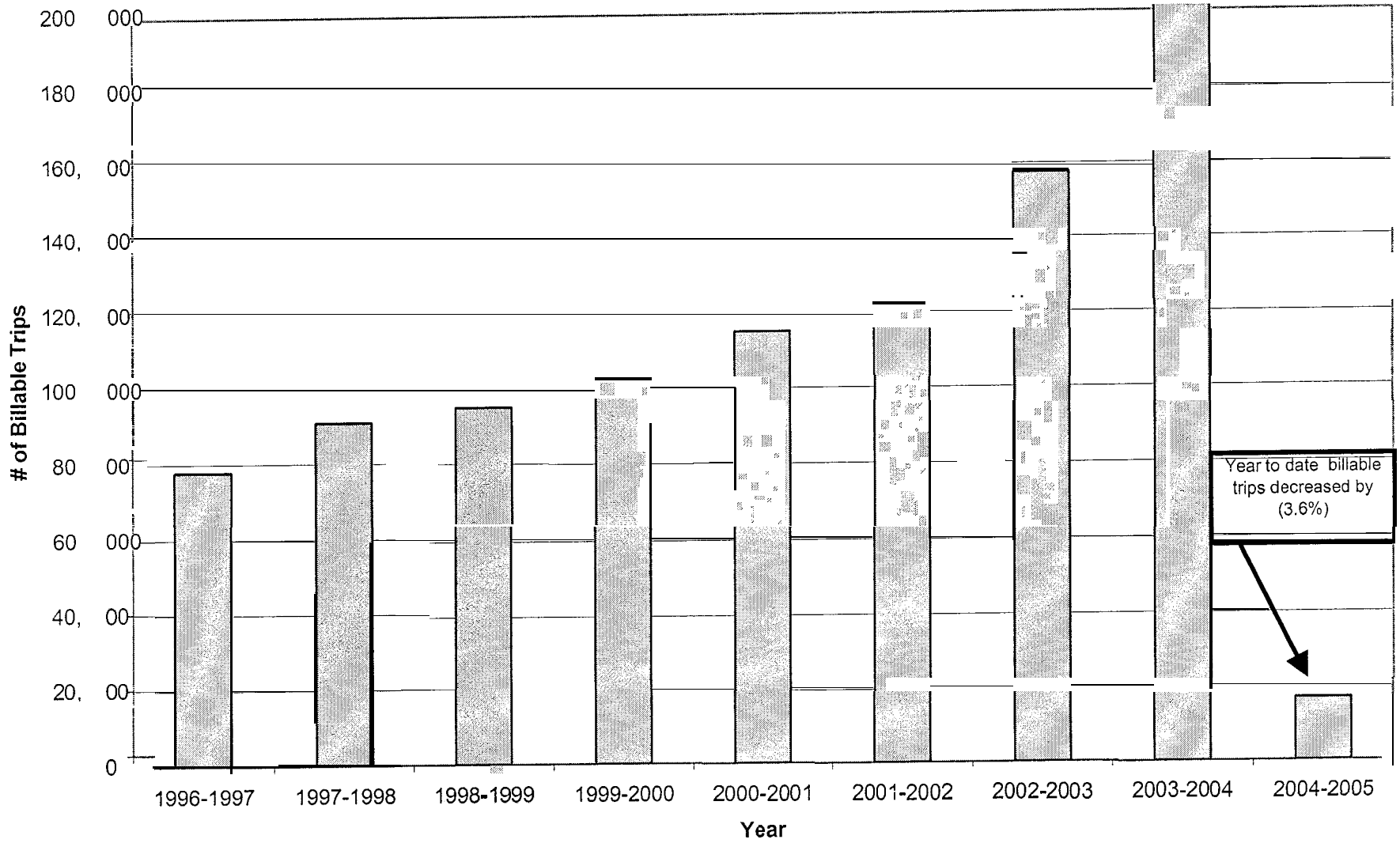

5-9. a2

# SANTA CRUZ METROPOLITAN TRANSIT DISTRICT

**DATE:** September 24, 2004  
**TO:** Board of Directors  
**FROM:** Frank L. Cheng, Project Manager  
**SUBJECT: STATUS OF THE METROBASE PROJECT**

## I. RECOMMENDED ACTION

**That the Board of Directors accept and file the MetroBase Status Report.**

## II. SUMMARY OF ISSUES

- The MetroBase Project is currently proceeding in accordance with the schedule attached to this Staff Report, which is the schedule that has been developed by RNL Design.
- The City of Santa Cruz Redevelopment Agency is continuing to work on the real estate acquisition and relocation phase of the project.
- On August 27<sup>th</sup>, the Board of Directors approved new design options for MetroBase Maintenance Building.

## III. DISCUSSION

The MetroBase Project is proceeding as per the attached timeline (Attachment A & B). The chart reflects the timeline and events that are contained in the schedule that has been developed by RNL Design. Using this document allows Metro to directly track the progress of the project. RNL Design is progressing on schedule at this point in the design and engineering process.

The completed components of the project for the review period are as follows:

### A. Right Of Way (ROW)

- Encroachment Lease @ 1200 River Street for 40 years, approved by Santa Cruz City Council, will be submitted to Metro Board of District for approval.
- Concluded escrow with owner of 1122 River Street
- Adopted Mitigated Negative Declaration (MND) and Addendum MND on August 27, 2004 meeting.

### B. Finance

- 25 Sakata Lane, Watsonville property being prepared for sale.
- Completed Initial appraisal of property.
- Appraisal review is underway.

### C. Architectural & Engineering (A&E)

5-10.1

- Approved new design options for Maintenance Building.
- RNL: Design Phase is 65% complete.
- RNL Design presented to the Board of Directors design and aesthetic issues on August 13<sup>th</sup> and 27<sup>th</sup>.

D. Construction Management (CM)

- Board of Director approved a contract for Construction Management services with Harris & Associates on June 25, 2004. Notice to proceed has been issued.

E. Construction Schedule

- Received bids on L/CNG Fueling Station equipment.
- Recommending Board of Directors authorization to purchase LCNG equipment on September 24<sup>th</sup>, 2004.
- Goal to request bids for General Construction on Jan. 2005 and award in Mar. 2005.
- Commencement and Completion of
  - i. Demolition of A Tool Shed, Surf City & Construct Service Facility in Apr. 2005 to Nov. 2005
  - ii. Demolition of Slo-Fill Fuel, Site Work, & Construction of Operations Building in Dec. 2005 to May. 2007
  - iii. Demolition of existing Operations Building and Final Site Work in Jul. 2007 to Sep. 2007
  - iv. Demolition of Parts Building & Construction of New Partial Maintenance Building in Apr. 2005 to May. 2006
  - v. Demolition of existing Maintenance Building & construct remainder of new Parts Building in Jul. 2006 to Dec. 2006
  - vi. Final Site Work in Feb. 2007 to Apr. 2007

#### IV. FINANCIAL CONSIDERATIONS

Regional Transportation Commission (RTC) is recommending to the County Transportation Commission (CTC), reprogram \$7.5 million is set aside for the MetroBase project.

#### V. ATTACHMENTS

**Attachment A:** Timelines

5-10.2

Construction Sequencing / Project Logistics Schedule  
 Santa Cruz Metropolitan Transit District  
 Metro Base

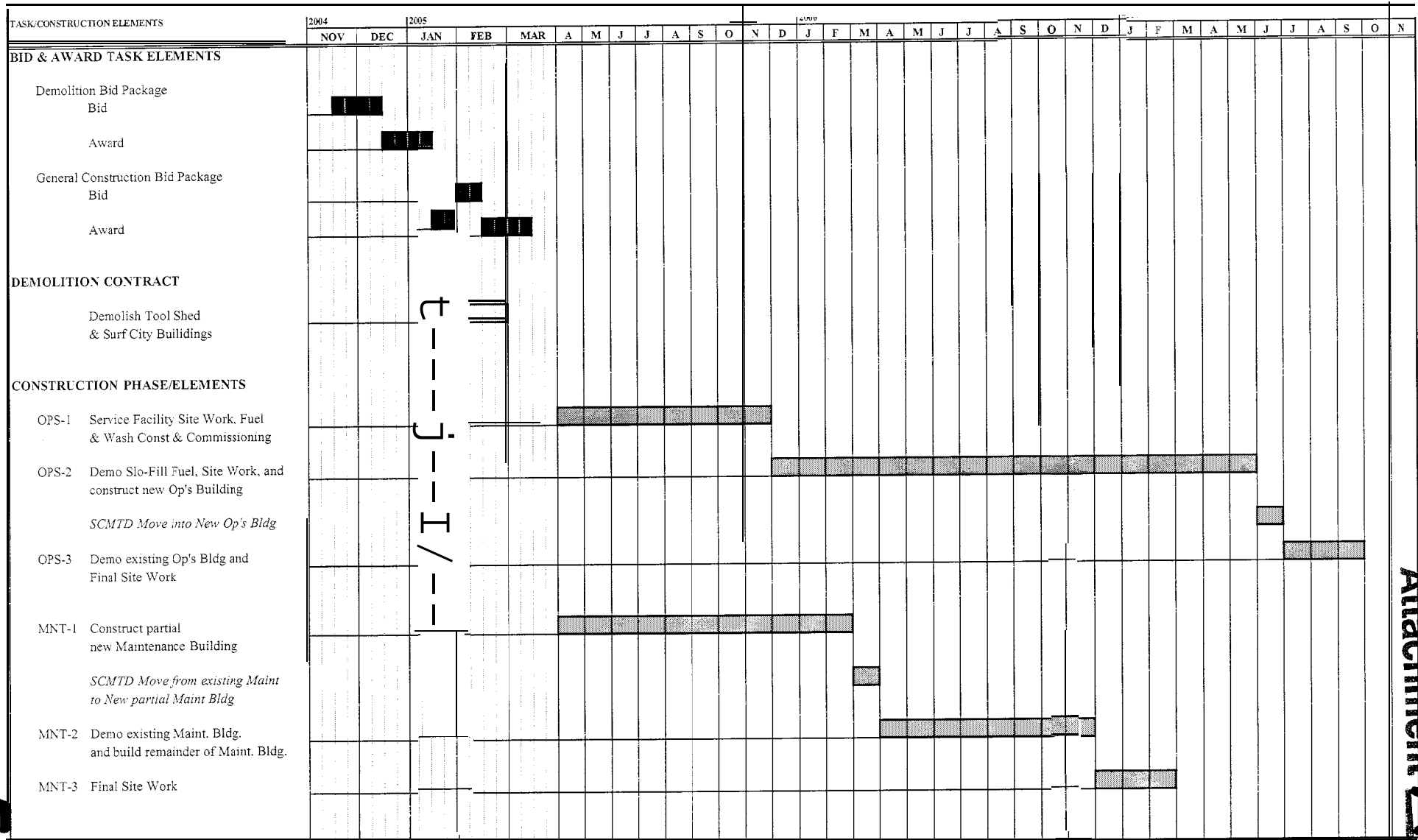

Attachment A

5-10.01

Up-Dated September 3, 2004

RNL Design

# SANTA CRUZ METROPOLITAN TRANSIT DISTRICT

**DATE:** September 24, 2004  
**TO:** Board of Directors  
**FROM:** Mark J. Dorfman, Assistant General Manager  
**SUBJECT:** **ACCEPT AND FILE VOTING RESULTS FROM APPOINTEES TO THE SANTA CRUZ COUNTY REGIONAL TRANSPORTATION COMMISSION FOR PREVIOUS MEETINGS**

## I. RECOMMENDED ACTION

**That the Board of Directors accept and file the voting results from appointees to the Santa Cruz County Regional Transportation Commission.**

## II. SUMMARY OF ISSUES

- Per the action taken by the Board of Directors, staff is providing the minutes from the most recent meetings of the Santa Cruz County Regional Transportation Commission.
- Each month staff will provide the minutes from the previous month's SCCRTC meetings.

## III. DISCUSSION

At the January Board of Directors Meeting of the Santa Cruz Metropolitan Transit District, the Board requested that staff include in the Board Packet information relating to the voting results from the appointees to the Santa Cruz County Regional Transportation Commission. Staff is enclosing the minutes from these meetings as a mechanism of complying with this request.

## IV. FINANCIAL CONSIDERATIONS

There is no cost impact from this action.

## V. ATTACHMENTS

**Attachment A:** Minutes of the July 27, 2004 Regular SCCRTC Meeting

5-11.1

# Attachment A

SANTA CRUZ COUNTY REGIONAL TRANSPORTATION COMMISSION  
AND  
SERVICE AUTHORITY FOR FREEWAY EMERGENCIES

MINUTES

Thursday,  
July 27, 2004  
9:00 a.m.

Board of Supervisors Chambers  
701 Ocean Street  
Santa Cruz CA 95060

1. Roll Call

Members Present:      Jan Beautz                      Dennis Norton  
                                 Mike Keogh                      Pat Spence  
                                 Scott Kennedy                  Ellen Pirie  
                                 Randy Johnson                  Mark Stone  
                                 Mardi Wormhoudt  
                                 Edenilson Quintanilla (Alt)

Members Absent:      Richard De La Paz      Emily Reilly

Staff Present              Linda Wilshusen              Pat Dellin  
                                 Kim Shultz                      Rachel Moriconi  
                                 Gini Pineda                      Luis Mendez

2. Oral Communications

Jeff Le Blanc said he was disappointed in the Commission because funding for the Metro had been whittled down and that everything but the MetroBase was included in the STIP.

Dave Eselius said that there has been a great deal of investment in the Metro producing very little benefit to the ridership. He said an HOV lane, as proposed, is of no benefit to those driving on the freeway and that taxpayers will not see a benefit from an HOV lane.

Ed Davidson said HOV lanes are necessary if carpools and busses are going to be able to bypass congested traffic and that the benefits outweigh the concerns.

Commissioner Keogh called for a Closed Session item at the August Regional Transportation Commission meeting regarding the rail right-of-way acquisition. Commissioner Beautz said the item was already on the agenda.

5-11.91



Commissioner Spence said that having the MetroBase funded in the 2004 STIP is critical since contracts can't be signed by SCMTD General Manager Les White if he can't show where funding is coming from.

3. Additions or Deletions to Consent and Regular Agendas

Deputy Director Pat Dellin noted replacement page 4-4 and an email to the Commission from the Grand Jury agreeing to provide members to the independent audit committee.

CONSENT AGENDA (Pirie/Wormhoudt)

4. Approved Minutes of June 3, 2004 Regular SCCRTC Meeting (Stone/Quintanilla abstained)
5. Approved Minutes of June 3, 2004 Evening Public Hearing (Stone/Quintanilla abstained)
6. Approved Minutes of June 17, 2004 Transportation Policy Workshop Meeting
7. Accepted Draft Minutes of June 7, 2004 and June 15, 2004 Expenditure Plan Subcommittee Meetings (Commissioner Kennedy abstained)

REGULAR AGENDA

8. Approve Addendum to the 2001 Regional Transportation Plan's Environmental Impact Report to Address the Local Transportation Sales Tax Measure and Approve Final Expenditure Plan and Ordinance for Local Transportation Sales Tax Measure

Deputy Director Pat Dellin reviewed the staff recommendations. She highlighted the amended language describing the HOV lane as it would appear on the Expenditure Plan and said that, at the suggestion of County Counsel, ballot language had been rephrased as a question rather than a statement. Ms. Dellin said that four of the five entities asked to provide members to the Independent Audit Committee had agreed to do so.

Commissioner Beautz said she thought four members would suffice since the Committee served only as an oversight committee. Ms. Dellin said that the new staff recommendation would be that the committee would consist of four members.

Commissioner Beautz asked for public comment prior to discussing the staff recommendations.

Ed Davidson said he was opposed to spending any money on the rail acquisition because light rail has no future and will not solve traffic congestion. He said the tourist trolley project can't even get a feasibility study done in time for the Environmental Impact Report and that a bike path is a waste of money, contending that the County already has a fine bike network and that the Broadway/Brommer corridor would be a better option than a path along the rail right-of-way. He concluded by saying that the rail line parallels places no one wants to go to.

Bob Yont said that the Expenditure Plan did not provide enough funding for elderly and disabled persons and that a 10% share of the sales tax revenues is more realistic given the demographics of an aging population.

Debbie Bulger asked for clarification if other projects in the Expenditure Plan could be pre-empted by the highway project for bonds and other fundraising measures.

Commissioner Beautz said that her understanding was that local jurisdictions were guaranteed their share every year. She asked Chief Assistant County Counsel Rahn Garcia if that was correct.

Deputy Director Pat Dellin responded and said that Assistant CAO Pat Busch had prepared the financial plan for the expenditure plan and had told the Commission that it would be 'very unlikely that each of the percentages would not be distributed every year. She said that the highway bond debt service would have priority to be paid first, but that the economy would have to be extremely bad before the local jurisdictions could not receive their full share each year.

Dave Eselius said that nothing has justified building an HOV lane and does not think it will work. He said that there was not enough information to purchase the rail right-of-way.

Spike Alper said that since 1991 the number of HOV lanes has increased but that ridership stays the same and that he hopes those who know widening won't work will have the guts to say so.

Paul Elerick said he would prefer if the Expenditure Plan did not specify that debt servicing for any highway bonds would take precedence over other distributions. He also asked for a clearer definition of the boundaries of the project, saying that simply referring to "Aptos" was too vague.

5-11.a3

Jeff Le Blanc said that by the time the HOV lane is built, no busses will be around anyway.

Commissioner Keogh asked if the language on pages 8-51 and 8-57 reflected the discussion regarding the use of the money allocated to the Coastal Bicycle/Pedestrian Trail at the June Commission meeting.

Chief Assistant County Counsel Rahn Garcia said as long as the ballot language is not inconsistent with the ordinance there shouldn't be a problem.

Commissioner Wormhoudt said that what had been discussed and voted on at the June meeting was confusing and may not reflect what the majority of the Commissioners wanted to convey. Ms. Wormhoudt said she continues to believe that allowing money to be used for acquisition of the rail right-of-way sends a message to Union Pacific that more money for acquisition is available. Commissioner Wormhoudt moved to change Section 4F of the Expenditure Plan to say that 4% of the sales tax revenues would be used only for the construction of a bicycle/pedestrian path. Commissioner Kennedy seconded.

Commissioner Pirie objected to the motion saying that the motion was being made by Commissioners who had already lost on this issue. She said she thinks what the Commission did was to keep another source available, if needed, to purchase the right-of-way.

Commissioner Beautz agreed that the Commission did discuss the passage and asked if there was a rule regarding voting on the same thing twice.

Chief Assistant County Counsel Rahn Garcia said he would have to consult the Robert's Rules of Order to see if there is a technical impediment to such a procedure.

Commissioner Stone said the ballot measure language refers to "building" a Coastal bike/walking path next to the rail line and it was up to the Commission to make the language clear and consistent with the Ordinance. He said the motion on the floor clears up any misunderstanding.

Commissioner Pirie contended that the motion on floor confused the issue.

Commissioner Wormhoudt asked why raise a technical matter and deny the Commissioners the right to vote on the issue.

Commissioner Spence asked if changing the ballot language to say "implement" rather than "building" would be acceptable.

5-11.04

Commissioner Wormhoudt said the change in language was not relevant to the motion and Commissioner Beautz said it was all right with her to proceed with the vote.

Commissioner Spence asked if the maker of the previous motion had to agree to this new vote.

Chief Assistant County Counsel Rahn Garcia said that after consulting with the Sturgess procedural guide he saw nothing that precludes Commissioner Wormhoudt's motion.

Commissioner Kennedy pointed out that he had seconded Commissioner Keogh's motion at the last meeting with the exact opposite intention as he had apparently misunderstood the language at this time.

Commissioner Pirie said if the motion is to add the words "construction of a bike trail" it takes confusion away.

Commissioner Wormhoudt said that the point of her motion is to limit the use of tax revenue money for construction only and not for acquisition of the rail right-of-way.

Commissioner Quintanilla said he had watched the video of the previous meeting and found the discussion to be confusing.

Commissioner Beautz said she did not think it was a good idea to limit the use of the funding to construction of a bike/pedestrian path in case application for Proposition 116 funding does not go through.

Commissioner Stone disagreed, saying that the motion is appropriate because the Commission has already authorized the use of Proposition 116 funds for acquisition.

The vote was taken with Commissioners Kennedy, Norton, Quintanilla, Stone and Wormhoudt voting in favor and Commissioners Beautz, Johnson, Keogh, Pirie and Spence voting against it. The motion failed due to a lack of a majority.

Commissioner Quintanilla moved to accept the staff recommendations.

Commissioner Stone moved to pull the Expenditure Plan out and vote on it separately.

It was agreed by consensus to vote on each recommendation separately.

5-11.05

Commissioner Pirie moved to approve the first recommendation of the staff report to:

Approve a resolution accepting the Addendum to the Environmental Impact Report (EIR) for the 2001 Regional Transportation Plan and requesting that the County Board of Supervisors approve the final Expenditure Plan and Ordinance and place the Local Transportation Sales Tax Measure on the November 2004 ballot at the special July 27, 2004 Board meeting to be held following this meeting.

Commissioner Johnson seconded.

Commissioner Stone expressed concern that the Commission was asking voters to approve something that they were not truly educated about and said if the if voters don't approve the ballot measure there would be an opportunity to revisit transportation options for the Expenditure Plan.

Commissioner Kennedy said he will vote against the recommendation saying the he wanted the City of Santa Cruz to be part of a plan that addressed a broad range of transportation options and that part of that commitment was a commitment to acquire the rail right-of-way. He said it was a waste of time, money and good faith to put the measure on the November ballot.

Commissioner Norton said he will vote in the City of Capitola's best interest and let the public make the decision. He reiterated the City's concern that it is not receiving its fair share of the revenues.

Commissioner Wormhoudt said she has supported putting the measure on the ballot longer than anyone and although she is concerned about approving the addendum to the 2001 Regional Transportation Plan Environmental Impact Report, she thinks it's time to move the debate into the public arena.

Commissioner Pirie said that there is a tremendous need for a variety of improvements and that the sales tax revenues offer local control to implement these improvements. She highlighted the importance of building the Pajaro train station.

The motion passed with Commissioner Kennedy voting "no".

Commissioner Stone objected to the Expenditure Plan saying it is a compromise but falls short because there is not enough money for everything on the plan. He asked if the Commission will be willing to sacrifice Phase II of the Hwy 1 Widening/HOV project if it turns out that Phase I costs more than anticipated.

5-11.96

Commissioner Wormhoudt said she would not support the Expenditure Plan because the plan is insufficient to meet the needs for a variety of services and that only 8% of the funding is designed for non-road related projects. She said the 30 year tax measure exhausts capacity for bonding for any other transportation projects and added if the second phase of the highway widening had not been added there would have been a good deal more money for other projects.

Commissioner Pirie moved to approve the Final Local Transportation Sales Tax Measure Expenditure Plan and Ordinance, as revised. Commission Alternate Quintanilla seconded and the motion passed with Commissioners Beautz, Johnson, Keogh, Pirie, Quintanilla and Spence in favor of the motion and Commissioners Kennedy, Norton, Stone and Wormhoudt voting against it.

Commissioner Wormhoudt moved to approve the third staff recommendation to accept responses from potential appointers of members to the Independent Audit Committee. Commissioner Pirie seconded and made it clear that the Commission had agreed that the Committee would consist of four members. The motion passed unanimously.

Commissioner Pirie moved to accept the fourth staff recommendation to approve minor revisions to the ballot language, suggested by County Counsel. Commission Alternate Quintanilla seconded and the motion passed unanimously.

9. Next Meetings/Adjournment

The meeting adjourned at 10:20 a.m.

The next regular SCCRTC meeting is scheduled for Thursday, August 5, 2004 at 9:00 a.m. at Board of Supervisors Chambers, 701 Ocean Street, Santa Cruz CA 95060.

The next Transportation Policy Workshop is scheduled for Thursday, August 19, 2004 at 9:00 a.m. at the SCCRTC offices, 1523 Pacific Avenue, Santa Cruz, CA 95060.

Respectfully submitted,

---

Gini Pineda, Staff

5-11.07

ATTENDEES

Name

Representing

|                    |                           |
|--------------------|---------------------------|
| Debbie Bulger      | Mission Pedestrians       |
| Paul Elerick       | CFST                      |
| Peter Scott        | CFST                      |
| David Wright       | Friends of the Rail Trail |
| Piet Canin         | Bike to Work              |
| David Eselius      |                           |
| Jim Conklin        | Business Council          |
| Sandra Coley       | PVTMA                     |
| Jeff Le Blanc      |                           |
| Don Hoernschemeyer | CFST                      |
| Ed Davidson        |                           |
| Les White          | SCMTD                     |
| Mark Dettle        | City of Santa Cruz        |
| Bonnie Morr        | UTU Local 23              |
| Brian Petersen     |                           |
| Jan Kampa          |                           |
| Robert Yont        |                           |
| Spike Alper        |                           |

\\Rtcserver1\Shared\RTC\2004\0704\TCMinutes0704.doc

5-11.08

# SANTA CRUZ METROPOLITAN TRANSIT DISTRICT

**DATE:** September 24, 2004  
**TO:** Board of Directors  
**FROM:** Tom Stickel, Manager of Fleet Maintenance  
**SUBJECT:** **CONSIDERATION OF CONTRACT EXTENSION WITH DEVCO OIL, INC. FOR DIESEL AND GASOLINE FUEL**

## I. RECOMMENDED ACTION

**It is recommended that the Board of Directors authorize the General Manager to enter into a one-year contract extension with Devco Oil, Inc. for diesel and gasoline fuel.**

## II. SUMMARY OF ISSUES

- The District has had a contract with Devco Oil, Inc. to provide diesel and gasoline fuel for the past three years.
- The current contract, approved by the Board of Directors on September 21, 2001, was for a term of three years with two (2) one-year options for renewal.
- Devco Oil has provided excellent service and a one-year extension of the contract is recommended.

## III. DISCUSSION

The Santa Cruz Metropolitan Transit District requires the supply of diesel and gasoline fuel for use in its fleet. The estimated monthly requirements for this contract are 80,000 gallons of diesel fuel and 2,000 gallons of unleaded gasoline fuel per month. The District does not have its own diesel or gasoline fueling facilities, so it is necessary for the fueling to be done off-site at the facilities of the provider of the fuels. Since each vehicle will have to be transported to the contractor's facility on a daily basis, it is imperative that the facility used for the delivery of fuel be within a lo-block radius of the District's Operations Facility at 1200 River Street.

On September 21, 2001, the Board of Directors authorized the General Manager to execute a three-year contract with the option of two (2) one-year extensions with Devco Oil, Inc. The selection of Devco Oil, Inc. was the result of an Invitation for Bid (IFB) process, which was issued on July 30, 2001. Devco Oil, Inc. has provided excellent service and has offered to reduce the price of diesel fuel for the next contract period by 0.0155 cents per gallon effective October 1, 2004. This would save the District over \$14,000 per year over the current contract price structure. District staff recommends that the Board of Directors authorize the General Manager to sign a one-year contract extension on behalf of the District.

5-12.1



**IV. FINANCIAL CONSIDERATIONS**

Funding for this contract is contained in the Operating Budget. The annual budget for diesel and gasoline fuel is \$ 1,750,000.

**V. ATTACHMENTS**

- Attachment A:** Letter from Devco Oil, Inc  
**Attachment B:** Contract Amendment

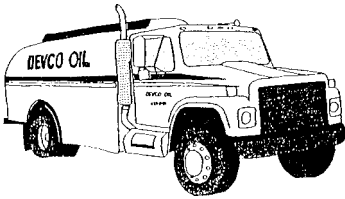

## DEVCO OIL, INC.

139 Encinal Street  
P O Box 473  
Santa Cruz, CA 95060  
Phone 831 423-2121  
Fax 831 423-4128

Fuel  
•  
Lubricants  
•  
Cardlock

member of



# Attachment A

August 5, 2004

Mr. Lloyd Longnecker  
District Buyer  
Santa Cruz Metropolitan Transit District  
370 Encinal St. Suite #100  
Santa Cruz, Ca. 95060

Re: Renewal of District Contract No. 01-03 for Supply of Diesel and Gasoline Fuels

Dear Mr. Longnecker:

Devco Oil Co., Inc. is in agreement for the extension of the fuel contract from Oct. 1, 2004 thru Sept. 30, 2005. All conditions will remain the same as prior agreement, with the exception of pricing. Devco Oil Co. agrees to a .0155 cents per gallon reduction in price of Diesel Fuel to district. Prior contract: cost plus .1505 per gallon. New contract cost plus .135 per gallon. If these terms are agreeable to the district, you may contact me with your reply.

Sincerely,

Jerry Belcher  
General Manager/ CFO

5-12.a1

**SANTA CRUZ METROPOLITAN TRANSIT DISTRICT  
FIRST AMENDMENT TO CONTRACT NO. 01-03  
FOR SIJPLY OF DIESEL AND GASOLINE FUELS**

This First Amendment to Contract No. 01-03 for supply of diesel and gasoline fuels is made effective October 1, 2004 between the Santa Cruz Metropolitan Transit District, a political subdivision of the State of California ("District") and Devco Oil, Inc. ("Contractor").

**I. RECITALS**

1.1 District and Contractor entered into a Contract for supply of diesel and gasoline fuels ("Contract") on October 1, 2001.

1.2 The Contract allows for the extension upon mutual written consent.

Therefore, District and Contractor amend the Contract as follows:

**II. TERM**

2.1 Article 3.02 is amended to include the following language:

This contract shall continue through September 30, 2005. This Contract may be mutually extended by agreement of both parties.

**III. COMPENSATION**

3.1 Article 4.01 is amended to include the following language:

Effective October 1, 2004, Contractor shall reduce the price of diesel fuel by 0.0155 cents per gallon.

**IV. REMAINING TERMS AND CONDITIONS**

4.1 All other provisions of the Contract that are not affected by this amendment shall remain unchanged and in full force and effect.

**V. AUTHORITY**

5.1 Each party has full power to enter into and perform this First Amendment to the Contract and the person signing this First Amendment on behalf of each has been properly authorized and empowered to enter into it. Each party further acknowledges that it has read this First Amendment to the Contract, understands it, and agrees to be bound by it.

SIGNATURES ON NEXT PAGE

5-12.61

Signed on \_\_\_\_\_

DISTRICT  
SANTA CRUZ METROPOLITAN TRANSIT DISTRICT

---

Leslie R. White  
General Manager

CONTRACTOR  
DEVCO OIL, INC.

BY \_\_\_\_\_

Jerry Belcher  
General Manager, CFO

APPROVED AS TO FORM:

---

Margaret R. Gallagher  
District Counsel

5-12.62

# SANTA CRUZ METROPOLITAN TRANSIT DISTRICT

**DATE:** September 24, 2004  
**TO:** Board of Directors  
**FROM:** Tom Stickel, Manager of Fleet Maintenance  
**SUBJECT:** CONSIDERATION OF CONTRACT EXTENSION WITH CLAREMONT BEHAVIORAL, SERVICES FOR EMPLOYEE ASSISTANCE PROGRAMS

## I. RECOMMENDED ACTION

**It is recommended that the Board of Directors authorize the General Manager to enter into a one-year contract extension with Claremont Behavioral Services for employee assistance programs.**

## II. SUMMARY OF ISSUES

- The District has had a contract with Claremont Behavioral Services to provide employee assistance programs for the past two years.
- The current contract, approved by the Board of Directors on October 25, 2002, was for a term of two years with three (3) one-year options for renewal.
- Claremont Behavioral Services has provided excellent service and a one-year extension of the contract is recommended.

## III. DISCUSSION

The Employee Assistance Program provides an opportunity for all District employees and their dependents to obtain confidential assistance in resolving personal or work-related problems. The Employee Assistance Program would provide confidential professional counseling, assessment and referral for the District's approximately 300 employees and their dependents in an effort to address such problems relating to, but not limited to, marriage and family, psychological health, substance abuse, or financial difficulties.

On July 5, 2002, District Request for Proposal No. 02-02 was mailed to several firms and was legally advertised. On August 2, 2002, proposals were received and opened from five (5) firms. On October 25, 2002, the Board of Directors authorized the General Manager to execute a two-year contract with the option of three (3) one-year extensions with Claremont Behavioral Services. Claremont Behavioral Services has provided excellent service and District employees have used the programs significantly. The average in this industry for the number of employees using the service is 5%. The attached Claremont report (Attachment A) shows that the District usage was at 24% for the first year of the contract and 12% so far in the second year of the contract. Claremont Behavioral Services has proposed a rate increase from \$2.90 per employee

5-13.1

per month to \$3.20 per employee per month for the next contract period (10.34% increase). This proposed rate is still competitive with the rates received from other service providers over two years ago.

Claremont Behavioral Services, Inc. has also added the following services effective December 1, 2004:

- School/College Assistance
- Adoption Assistance
- Pet Care Referrals

District staff recommends that the Board of Directors authorize the General Manager to sign a one-year contract extension on behalf of the District and allow a rate increase to \$3.20 per employee per month.

#### **IV. FINANCIAL CONSIDERATIONS**

Funding for this contract is contained in the Operating Budget. The estimated annual budget for this contract based on 294 employees is approximately \$11,300.

#### **V. ATTACHMENTS**

**Attachment A:** Letter from Claremont Behavioral Services, Inc.  
**Attachment B:** Contract Amendment

# CLAREMONT EAP

## EMPLOYEE ASSISTANCE PROGRAM Renewal

|                      |        |  |        |
|----------------------|--------|--|--------|
| Group:               |        | Santa Cruz Metropolitan Transit District |        |
| Renewal Date:        |        | December 1, 2004                         |        |
| Number of Employees: |        | 294                                      |        |
| CURRENT RATE         | \$2.90 | RENEWAL RATE                             | \$3.20 |

Claremont received the letter from Lloyd Longnecker, District Buyer, dated August 2, 2004. We would like to extend the EAP contract for an additional year from 12/1/2004-11/30/2005, but would ask that the district consider the above rate increase.

The District's utilization has been extremely high at 24.4% the first year and 12% so far **this** year. The average in this industry is around 5% so usage is still quite high. Claremont provided 17 onsite orientation sessions for Mgrs and employees. We also responded with an onsite counselor for a Critical Incident Stress Debriefing on 3 different dates for a total of 7 hours. In addition to our regular quarterly newsletters and Resource Packets we provide for all customers, we provide a customized promotional piece on alternate months so the District can send an EAP promotion along with paychecks every month.

The above rate will be in effect for twelve (12) months from the renewal date.

The following services will continue to be included for this plan year:

- 3 Counseling Visits per Family Member per Incident
- Legal/Financial Consultations
- Elder/Child Care Referrals
- 8 Free Brown Bag Seminars per Contract Year
- 3 Hours Onsite for Critical Incident Stress Debriefings (CISD's) per Incident
- Unlimited HR & Management Consultations
- 8 Free Hours for Orientations/Health Fairs/Open Enrollment per Contract Year
- Semi-Annual Utilization Reports

Due to low utilization, the Medical Advice Line will not be included for this plan year.

The following services are being added for this year:

- School/College Assistance
- Pet Care Referrals
- Adoption Assistance

Claremont remains committed to do "whatever it takes" to meet your needs. Please let me know if you **have any questions**.

Best Regards,



LAURIE B. SLEZ  
Director of Account Services

RECEIVED  
 2004 JUN 19 AM 9:14  
 SANTA CRUZ METRO  
 TRANSIT DISTRICT

# CLAREMONT EAP

Santa Cruz Metropolitan Transit District  
Annual Utilization Report

Reporting Period: 12/1/2002 to 11/30/2003

Total Utilization Based on Average Number of Employees: 295

|                 | Cases<br>This Year | Annual<br>Utilization |
|-----------------|--------------------|-----------------------|
| Total Cases     | <u>72</u>          | <u>24.4 %</u>         |
| Clinical        | 32                 | 10.8 %                |
| Life Management | 40                 | 13.5 %                |

## New Cases: Clinical

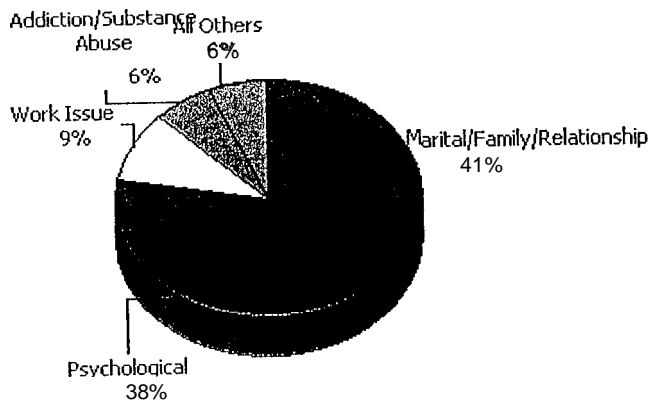

|                             | This<br>Year |
|-----------------------------|--------------|
| Total Clinical Cases        | <u>32</u>    |
| Marital/Family/Relationship | 13           |
| Psychological               | 12           |
| Work Issue                  | 3            |
| Addiction/Substance Abuse   | 2            |
| Other                       | 2            |
| Medical                     | 0            |

## New Cases: Life Management

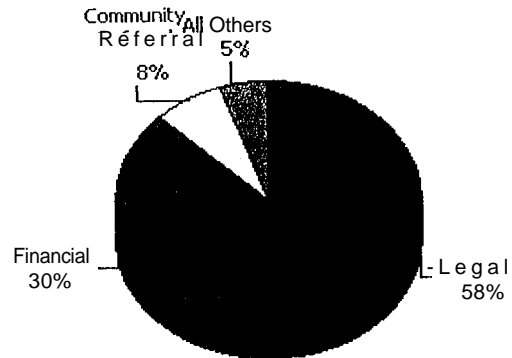

|                       | This<br>Year |
|-----------------------|--------------|
| Total Life Mgmt Cases | <u>40</u>    |
| Legal                 | 23           |
| Financial             | 12           |
| Community Referral    | 3            |
| Child Care            | 1            |
| Medical Advice        | 1            |
| Elder Care            | 0            |



# CLAREMONT EAP

Santa Cruz Metropolitan Transit District  
Annual Utilization Report

Reporting Period: 12/1/2002 to 11/30/2003

Referral Type for New Clinical  
and Life Management Cases

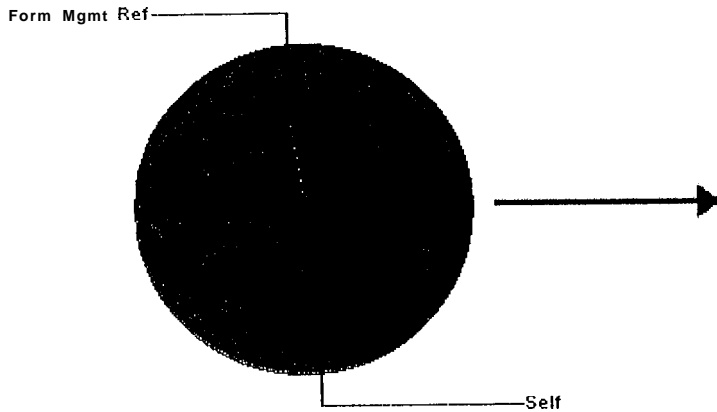

Source of Self-Referrals

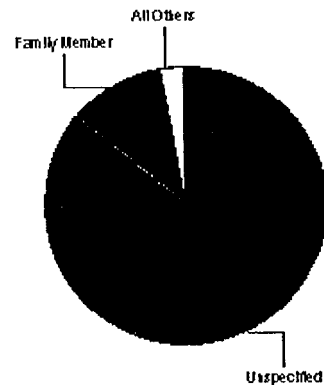

| <u>Referral Type</u>       | <u># of cases</u> | <u>% of cases</u> |
|----------------------------|-------------------|-------------------|
| Self                       | 70                | 97.2%             |
| Formal Management Referral | 2                 | 2.8%              |
|                            | 72                | 100.0%            |

| <u>Self-Referrals</u> | <u># of cases</u> | <u>% of cases</u> |
|-----------------------|-------------------|-------------------|
| Union                 | 2                 | 2.9%              |
| Family Member         | 8                 | 11.4%             |
| Unspecified           | 60                | 85.7%             |
|                       | 70                | 100.0%            |

New Cases: Employees vs. Family Members

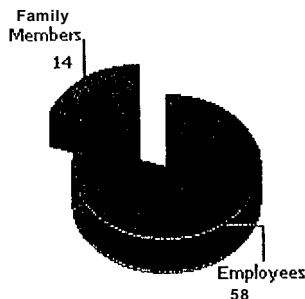

|                | <u># of cases</u> | <u>% of cases</u> |
|----------------|-------------------|-------------------|
| Employees      | 58                | 80.6%             |
| Family Members | 14                | 19.4%             |
|                | 72                | 100.0%            |

# CLAREMONT EAP

## Santa Cruz Metropolitan Transit District Annual Utilization Report

Reporting Period: 12/1/2002 to 11/30/2003

### Organizational Consultations

Number of Organizational Consultations 10

| Consultation Issues*                           | Frequency* |
|--|------------|
| Work Performance                               | 4          |
| Death of Co-worker                             | 3          |
| Conflict With Co-Worker(s)                     | 2          |
| Formal Work Discipline                         | 2          |
| Other Organizational Problem                   | 2          |
| Training Need                                  | 2          |
| Employee Personal Problem                      | 1          |
| Other Employee Problem                         | 1          |
| Traumatic Incident (Robbery, Natural Disaster) | 1          |

\* A single consultation may involve more than one issue, and thus the frequency reflects the total count for each type of issue across all consultations.

### Onsite Services

| Date of Service   | Intervention Description                 | Hours |                 |
|-------------------|--|-------|-----------------|
| June 9, 2003      | Critical Incident Stress Debriefing      | 2.00  | 14 participants |
| June 10, 2003     | Critical Incident Stress Debriefing      | 1.00  | 7 participants  |
| June 19, 2003     | Critical Incident Stress Debriefing      | 4.00  | 28 participants |
| November 17, 2003 | Conflict Resolution/Communication Skills | 1.00  | 3 participants  |
| November 20, 2003 | Conflict Resolution/Communication Skills | 1.00  | 4 participants  |

# CLAREMONT EAP

## Santa Cruz Metropolitan Transit District Annual Utilization Report

Reporting Period: 12/1/2002 to 11/30/2003

### Account Services

| Date of Service   | Service Description  |                 |
|-------------------|--|-----------------|
| December 17, 2002 | Orientation  | 13 participants |
| January 6, 2003   | Publicity Materials Sent: 50 wallet cards, 50 brochures, 4 posters, 15 other documents |                 |
| January 9, 2003   | Publicity Materials Sent: 50 wallet cards, 50 brochures, 4 posters                     |                 |
| January 22, 2003  | Distributed Newsletter (Quarterly Newsletter)  |                 |
| February 4, 2003  | Orientation  |                 |
| February 4, 2003  | Orientation  |                 |
| February 4, 2003  | Orientation  |                 |
| February 4, 2003  | Orientation  |                 |
| February 4, 2003  | Orientation  |                 |
| February 4, 2003  | Orientation  |                 |
| February 4, 2003  | Orientation  |                 |
| February 4, 2003  | Orientation  |                 |
| February 4, 2003  | Orientation  |                 |
| February 4, 2003  | Orientation  |                 |
| February 4, 2003  | Orientation  |                 |
| February 4, 2003  | Orientation  |                 |
| February 5, 2003  | Orientation  |                 |
| February 5, 2003  | Orientation  |                 |
| February 5, 2003  | Orientation  |                 |
| February 5, 2003  | Orientation  |                 |
| February 5, 2003  | Orientation  |                 |
| February 12, 2003 | Distributed Resource Packet (Financial Fitness Resource Packet)                        |                 |
| March 4, 2003     | Publicity Materials Sent: 10 brochures, 3 posters, 10 other documents                  |                 |
| March 11, 2003    | Publicity Materials Sent: 100 wallet cards, 120 brochures, 50 other documents          |                 |
| March 27, 2003    | Distributed Resource Packet  |                 |
| April 2, 2003     | Distributed Newsletter (2nd Quarter)   |                 |
| April 15, 2003    | Report Sent  |                 |
| May 28, 2003      | Distributed Resource Packet (Health and Wellness Resource Packet)                      |                 |
| June 4, 2003      | Report Sent  |                 |
| June 19, 2003     | Publicity Materials Sent: 50 other documents   |                 |
| July 7, 2003      | Distributed Newsletter (3rd Quarter Newsletter)  |                 |
| August 7, 2003    | Distributed Resource Packet (Estate Planning)  |                 |
| October 9, 2003   | Distributed Newsletter (4th Quarter Newsletter)  |                 |
| November 17, 2003 | Distributed Resource Packet (Healthy Travel)   |                 |

# CLAREMONT EAP

Santa Cruz Metropolitan Transit District  
Annual Utilization Report

Reporting Period: 12/1/2002 to 11/30/2003

## Client Satisfaction\*

Satisfaction with Initial Call

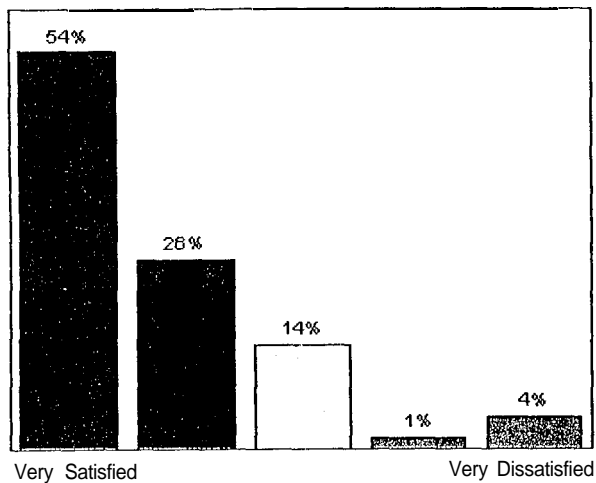

Satisfaction with EAP Counselor

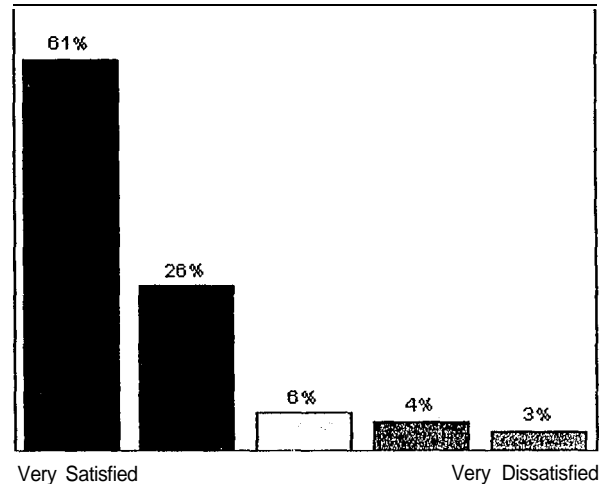

Was Initial Appointment with the EAP scheduled in a timely fashion?

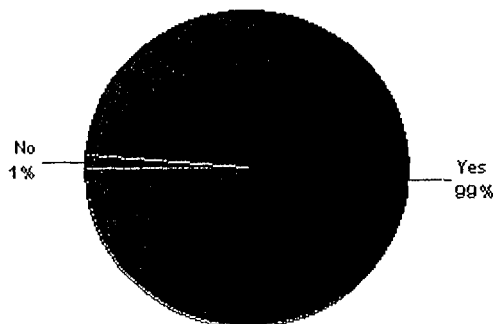

Would Recommend the EAP to a friend or colleague?



\*In order to protect client confidentiality, clinical outcome and satisfaction statistics are based on data across all Claremont groups. This data reflects surveys received over the previous 90 day period, and is refreshed monthly.

# CLAREMONT EAP

Santa Cruz Metropolitan Transit District  
Annual Utilization Report

Reporting Period: 12/1/2002 to 11/30/2003

## Clinical Case Outcomes\*

Self-Reported Helpfulness of EAP  
in Resolving Issue

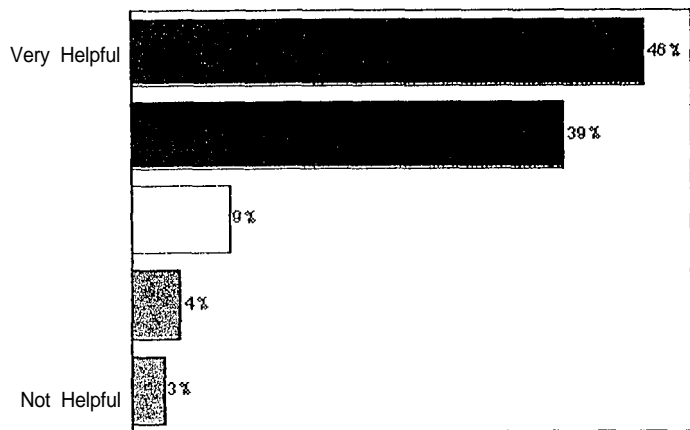

Self-Reported Effect of Issue on  
Work Performance

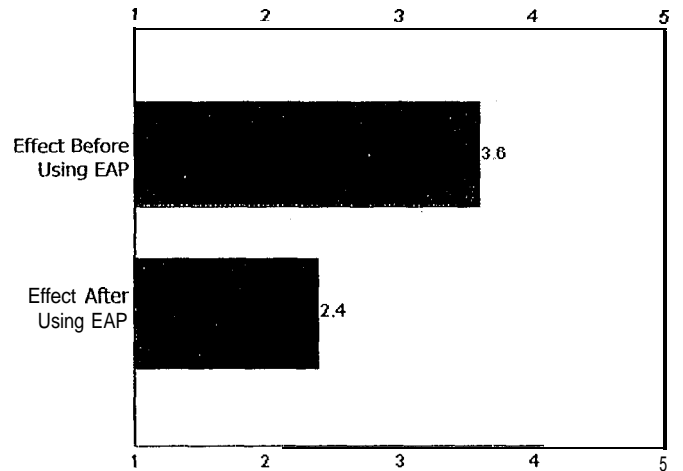

## Provider Reported Rating of Client Improvement

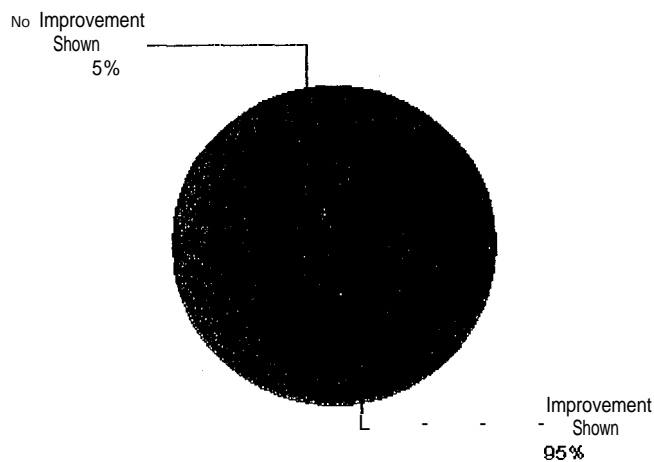

\*In order to protect client confidentiality, clinical outcome and satisfaction statistics are based on data across all Claremont groups. This data reflects surveys received over the previous 90 day period, and is refreshed monthly.

# CLAREMONT EAP

Santa Cruz Metropolitan Transit District  
Utilization Report

Reporting Period: 12/1/2003 to 7/31/2004  
Year-To-Date Reporting Period: 12/1/2003 to 7/31/2004

Total Utilization Based on Average Number of Employees: 292

|                 | Cases This Period | Cases YTD | Projected Annual Utilization |
|-----------------|-------------------|-----------|------------------------------|
| Total Cases     | 23                | 23        | 11.8%                        |
| Clinical        | 15                | 15        | 7.7%                         |
| Life Management | 8                 | 8         | 4.1%                         |

## New Cases: Clinical

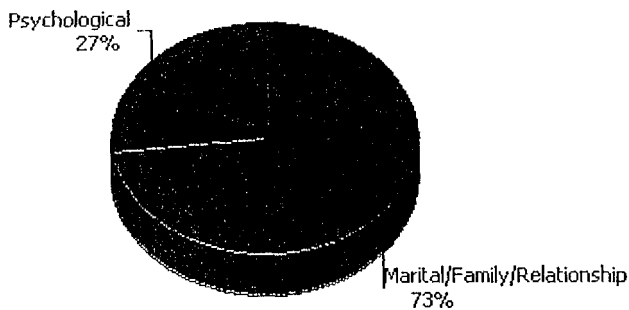

|                             | This Period |
|-----------------------------|-------------|
| Total Clinical Cases        | 15          |
| Marital/Family/Relationship | 11          |
| Psychological               | 4           |
| Addiction/Substance Abuse   | 0           |
| Medical                     | 0           |
| Work Issue                  | 0           |

## New Cases: Life Management

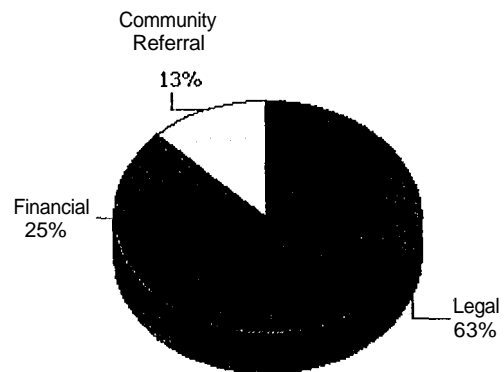

|                       | This Period |
|-----------------------|-------------|
| Total Life Mgmt Cases | 8           |
| Legal                 | 5           |
| Financial             | 2           |
| Community Referral    | 1           |
| Child Care            | 0           |
| Elder Care            | 0           |

# CLAREMONT EAP

Santa Cruz Metropolitan Transit District  
Utilization Report

Reporting Period: 12/1/2003 to 7/31/2004  
Year-To-Date Reporting Period: 12/1/2003 to 7/31/2004

Referral Type for New Clinical  
and Life Management Cases

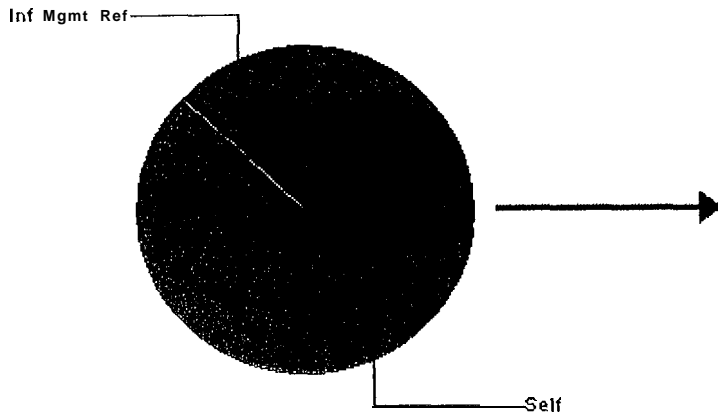

Source of Self-Referrals

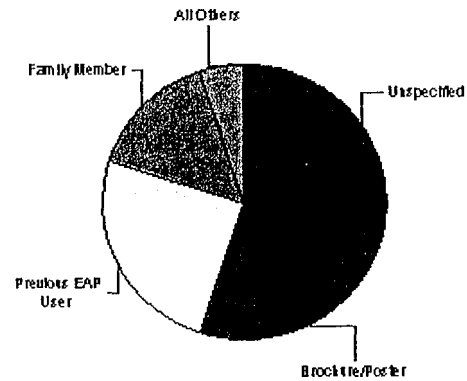

| <u>Referral Type</u>         | <u># of cases</u> | <u>% of cases</u> |
|------------------------------|-------------------|-------------------|
| Self                         | 20                | 87.0%             |
| Informal Management Referral | 3                 | 13.0%             |
|                              | 23                | 100.0%            |

| <u>Self-Referrals</u> | <u># of cases</u> | <u>% of cases</u> |
|-----------------------|-------------------|-------------------|
| Union                 | 1                 | 5.0%              |
| Brochure/Poster       | 5                 | 25.0%             |
| Family Member         | 3                 | 15.0%             |
| Previous EAP User     | 5                 | 25.0%             |
| Unspecified           | 6                 | 30.0%             |
|                       | 20                | 100.0%            |

New Cases: Employees vs. Family Members

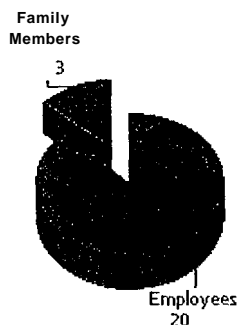

|                | <u># of cases</u> | <u>% of cases</u> |
|----------------|-------------------|-------------------|
| Employees      | 20                | 87.0%             |
| Family Members | 3                 | 13.0%             |
|                | 23                | 100.0%            |

# CLAREMONT EAP

Santa Cruz Metropolitan Transit District  
Utilization Report

Reporting Period: 12/1/2003 to 7/31/2004  
Year-To-Date Reporting Period: 12/1/2003 to 7/31/2004

## Organizational Consultations

|   |            |
|---|------------|
| Number of Organizational Consultations  | 1          |
| Consultation Issues*                    | Frequency* |
| <b>Organizational Problem (General)</b> | <b>1</b>   |

\* A *single* consultation may involve more than one issue, and thus the frequency reflects the total count for each type of issue across all consultations.

## Account Services

| Date of Service  | Service Description                                 |
|------------------|---|
| December 2, 2003 | Report Sent   |
| January 29, 2004 | Distributed Newsletter (1st Quarter)                |
| February 4, 2004 | Distributed Resource Packet (Resilience)            |
| February 5, 2004 | Program Development Consultation--Telephonic        |
| April 6, 2004    | Distributed Newsletter (2nd Quarter 2004)           |
| April 9, 2004    | Publicity Materials Sent: 4 other documents         |
| May 3, 2004      | Distributed Resource Packet (Work/Life Balance 101) |
| June 30, 2004    | Report Sent   |
| July 8, 2004     | Distributed Newsletter (3rd Qtr 2004)               |



# CLAREMONT EAP

Santa Cruz Metropolitan Transit District  
Utilization Report

Reporting Period: 12/1/2003 to 7/31/2004  
Year-To-Date Reporting Period: 12/1/2003 to 7/31/2004

## Client Satisfaction\*

Satisfaction with Initial Call

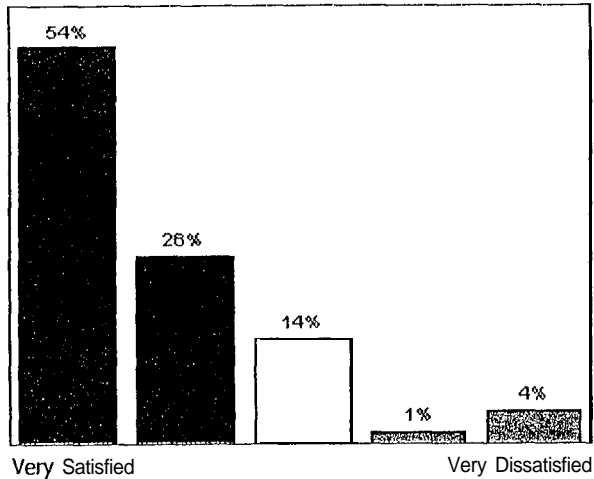

Satisfaction with EAP Counselor

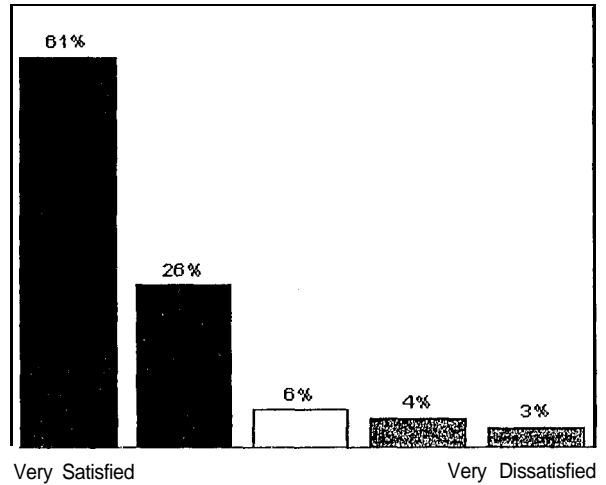

Was Initial Appointment with the EAP scheduled in a timely fashion?



Would Recommend the EAP to a friend or colleague?

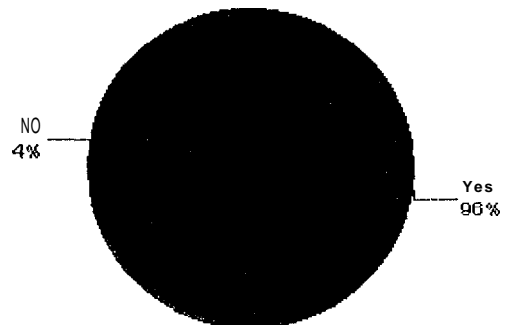

\*In order to protect client confidentiality, clinical outcome and satisfaction statistics are based on data across all Claremont groups. This data reflects surveys received over the previous 90 day period, and is refreshed monthly.

# CLAREMONT EAP

Santa Cruz Metropolitan Transit District  
Utilization Report

Reporting Period: 12/1/2003 to 7/31/2004  
Year-To-Date Reporting Period: 12/1/2003 to 7/31/2004

## Clinical Case Outcomes\*

Self-Reported Helpfulness of EAP  
in Resolving Issue

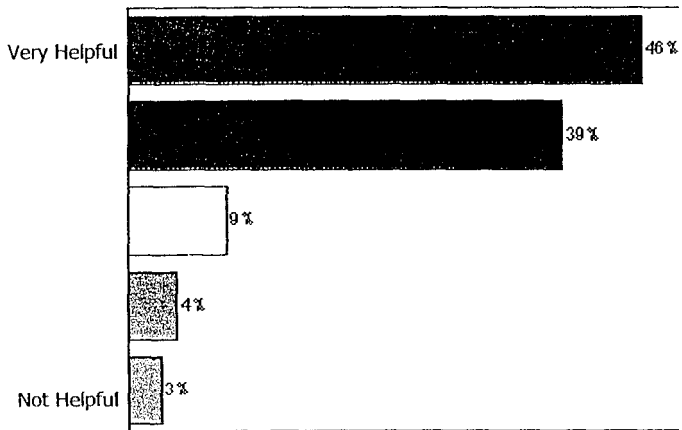

Self-Reported Effect of Issue on  
Work Performance

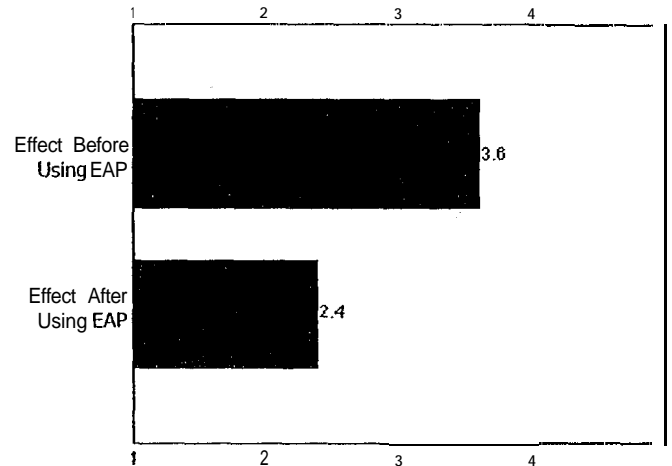

## Provider Reported Rating of Client **Improvement**

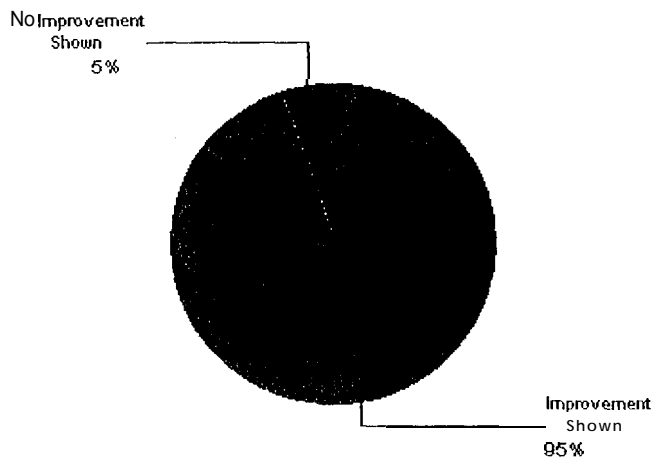

\*In order to protect client confidentiality, clinical outcome and satisfaction statistics are based on data across all Claremont groups. This data reflects surveys received over the previous 90 day period, and is refreshed monthly.

**SANTA CRUZ METROPOLITAN TRANSIT DISTRICT  
FIRST AMENDMENT TO CONTRACT NO. 02-02  
FOR EMPLOYEE ASSISTANCE PROGRAM SERVICES**

This First Amendment to Contract No. 02-02 for Employee Assistance Program Services is made effective December 1, 2004 between the Santa Cruz Metropolitan Transit District, a political subdivision of the State of California ("District") and Claremont Behavioral Services. ("Contractor").

**I. RECITALS**

- 1.1 District and Contractor entered into a Contract for Employee Assistance Program Services ("Contract") on December 1, 2002.
- 1.2 The Contract allows for the extension upon mutual written consent.
- 1.3 Contractor has offered additional program services and deletion of one program service.
- 1.4 Contractor requested a rate increase for the new contract term.

Therefore, District and Contractor amend the Contract as follows:

**II. TERM**

- 2.1 Article 4.01 is amended to include the following language:

This contract shall continue through November 30, 2005. This Contract may be mutually extended by agreement of both parties.

**III. COMPENSATION**

- 3.1 Article 5.01 is amended to include the following language:

Effective December 1, 2004, District shall compensate Contractor at a rate of \$3.20 per employee per month.

**IV. PROGRAM SERVICE CHANGES**

- 4.1 Effective December 1, 2004, the following service programs are added:
  - School/College Assistance
  - Pet Care Referrals
  - Adoption Assistance
- 4.2 Effective December 1, 2004, the following service program is deleted:
  - Medical Advice Line

**V. REMAINING TERMS AND CONDITIONS**

5.1 All other provisions of the Contract that are not affected by this amendment shall remain unchanged and in full force and effect.

**VI. AUTHORITY**

6.1 Each party has full power to enter into and perform this First Amendment to the Contract and the person signing this First Amendment on behalf of each has been properly authorized and empowered to enter into it. Each party further acknowledges that it has read this First Amendment to the Contract, understands it, and agrees to be bound by it.

Signed on \_\_\_\_\_

DISTRICT  
SANTA CRUZ METROPOLITAN TRANSIT DISTRICT

\_\_\_\_\_  
Leslie R. White  
General Manager

CONTRACTOR  
CLAREMONT BEHAVIORAL SERVICES.

BY \_\_\_\_\_  
Tom Bjornson  
President, CEO

APPROVED AS TO FORM:

\_\_\_\_\_  
Margaret R. Gallagher  
District Counsel

# SANTA CRUZ METROPOLITAN TRANSIT DISTRICT

**DATE:** September 10, 2004  
**TO:** Board of Directors  
**FROM:** Elisabeth Ross, Finance Manager  
**SUBJECT:** RESOLUTION ESTABLISHING A PETTY CASH FUND FOR THE PARACRUZ FACILITY

## I. RECOMMENDED ACTION

**Staff recommends that the Board of Directors adopt the attached resolution establishing a petty cash fund for the ParaCruz facility.**

## II. SUMMARY OF ISSUES

- The District maintains a petty cash fund at each operating facility for small purchases.
- The new ParaCruz facility at 2880 Research Park Drive, Soquel, will require a petty cash fund.
- An appropriate amount for the fund is \$200, the same amount as the petty cash fund at the River Street facility.

## III. DISCUSSION

A petty cash fund is maintained at each operating facility with an administrative office. The fund is used to reimburse designated departmental employees for small purchases under \$30 that are required to be made immediately, rather than waiting for the bi-weekly check run. The new ParaCruz facility will require such a fund.

## IV. FINANCIAL CONSIDERATIONS

Since purchases from the petty cash fund are charged against the appropriate department and account, there is no budgetary impact from this action.

## V. ATTACHMENTS

**Attachment A:** Resolution Establishing a Petty Cash Fund for the ParaCruz Facility.

5-14.1

BEFORE THE BOARD OF DIRECTORS OF THE  
SANTA CRUZ METROPOLITAN TRANSIT DISTRICT

Resolution No. \_\_\_\_\_ - -  
On the Motion of Director:  
Duly Seconded by Director: \_\_\_\_\_  
The Following Resolution is Adopted:

**RESOLUTION ESTABLISHING A PETTY CASH FUND  
FOR THE PARACRUZ FACILITY**

**WHEREAS**, the Santa Cruz Metropolitan Transit District has a need for a petty cash fund for the ParaCruz facility at 2880 Research Park Drive, Soquel, CA.

**NOW, THEREFORE, BE IT RESOLVED AND ORDERED**, that this Board does hereby authorize establishment of a petty cash fund for the ParaCruz facility containing a maximum amount of **\$200.00**;

**BE IT FURTHER RESOLVED AND ORDERED**, that the General Manager is hereby authorized and directed to draw a warrant in the amount of \$200.00 for such petty cash fund.

**PASSED AND ADOPTED** this 10<sup>th</sup> day of September, 2004, by the following vote:

**AYES:** Directors -

**NOES:** Directors -

**ABSTAIN:** Directors -

**ABSENT:** Directors -

**APPROVED** \_\_\_\_\_  
EMILY- REILLY  
Chairperson

**ATTEST** \_\_\_\_\_  
LESLIE R. WHITE  
General Manager

**APPROVED AS TO FORM:**

\_\_\_\_\_  
MARGARET GALLAGHER  
District Counsel

# SANTA CRUZ METROPOLITAN TRANSIT DISTRICT

**DATE:** September 10, 2004  
**TO:** Board of Directors  
**FROM:** Robyn D. Slater, Human Resources Manager  
**SUBJECT: CONSIDERATION OF APPROVAL OF CALPERS RESOLUTIONS TO FIX AND SET THE DISTRICT'S MEDICAL PREMIUM CONTRIBUTION RATES**

## I. RECOMMENDED ACTION

**It is recommended that the Board of Directors approve the attached Resolutions to revise the fixed contribution toward medical coverage for two of the Districts employee groups under the California Public Employee's Retirement System (CalPERS) medical insurance program and approve premium payment caps for represented Paratransit employees.**

## II. SUMMARY OF ISSUES

- METRO contracts with CalPERS to provide employee/retiree medical insurance coverage.
- In December 2003 METRO passed separate resolutions as required by CalPERS to establish the maximum monthly premium contributions that METRO would pay for SEIU Local 415 and management employees beginning in 2004.
- The Memorandum of Understanding with SEIU Local 415 includes language which guarantees METRO will "pay premiums at a level sufficient to cover the cost of the basic monthly medical insurance premiums for HMO plans... by the CalPERS medical program".
- Medical premiums paid by METRO for management employees mirror the agreements as set forth in SEIU Memorandum of Understanding.
- As of January 2005 the cost of premiums for CalPERS HMO has increased requiring new resolutions for SEIU Local 415 and management employees.
- As a result of the newly adopted Labor Agreement with UTU Paratransit employees a resolution must be adopted setting premium contributions for this group of employees. The premium contribution for UTU represented Paratransit employees will mirror the limits set for SEIU and Management.

## III. DISCUSSION

The California Public Employees' Medical and Hospital Care Act requires local public agencies contracting with CalPERS for employee medical insurance to fix the amount of the employer's

5-15.1

contribution(s). METRO established fixed maximum monthly contributions with CalPERS effective January 1, 2004. In 2005 the monthly premiums for the CalPERS HMO exceeds the fixed maximum monthly contributions established with CalPERS. In order to revise the maximum monthly contributions, the attached Resolutions must be approved by the Board of Directors and submitted to CalPERS. For the newly established Paratransit department represented by UTU a resolution must be adopted so CalPERS can establish monthly contribution amounts. The maximum monthly contribution rates for UTU represented Paratransit employees and the maximum monthly contributions by METRO for SEIU Local 415 and management employees have changed for 2005 to:

| <u>Enrollment</u>            | <u>old maximum</u> | <u>2005 rate</u> |
|------------------------------|--------------------|------------------|
| Employee/retiree only        | \$315.22           | \$ 389.96        |
| Employee/retiree + 1         | \$630.44           | \$ 779.92        |
| Employee/retiree + 2 or more | \$819.77           | \$1,013.90       |

#### **IV. FINANCIAL CONSIDERATIONS**

The increased cost has been addressed in the current budget.

#### **V. ATTACHMENTS**

- Attachment A:** A Resolution fixing the contribution under the Public Employees' Medical and Hospital Care Act for the Management Unit.
- Attachment B:** A Resolution fixing the contribution under the Public Employees' Medical and Hospital Care Act for the Service Employees International Union Local 415.
- Attachment C:** A Resolution electing to be subject to Public Employees' Medical and Hospital Care Act for the Paratransit employees represented by United Transportation Union Local 23 and fixing the Employer's contribution.



BEFORE THE BOARD OF DIRECTORS OF THE  
SANTA CRUZ METROPOLITAN TRANSIT DISTRICT

Resolution No. \_\_\_\_\_

On the Motion of Director: \_\_\_\_\_

Duly Seconded by Director: \_\_\_\_\_

The Following Resolution is Adopted:

**A RESOLUTION OF THE  
SANTA CRUZ METROPOLITAN TRANSIT DISTRICT  
FIXING THE CONTRIBUTION UNDER THE PUBLIC EMPLOYEES' MEDICAL AND  
HOSPITAL CARE ACT FOR THE MANAGEMENT UNIT**

**WHEREAS**, Government Code Section 22825.6 provides that a local agency contracting under the Public Employees' Medical and Hospital Care Act shall fix the amount of the employer's contribution at an amount not less than the amount required under Section 22825 of the Act: and

**WHEREAS**, Santa Cruz Metropolitan Transit District, hereinafter referred to as Public Agency, is a local agency contracting under the Act for participation by members in the non-represented Management Unit who are employees and annuitants of the agency;

**NOW, THEREFORE, BE IT RESOLVED**, that the employer's contribution for each employee or annuitant of the non-represented Management Unit shall be the amount necessary to pay a portion or full cost of his/her enrollment, including the enrollment of his/her eligible family members, in a health benefits plan up to a maximum of the Blue Shield basic/supplemental premium rates based on the employee's designated category (employee only, employee plus one, family); plus administrative fees and Contingency Reserve Fund Assessments.

**BE IT FURTHER RESOLVED AND ORDERED**, that the Board of Directors appoint and direct, and it does hereby appoint and direct the Human Resources Manager to file with the Board of Administration of the Public Employees' Retirement System a verified copy of this Resolution, and to perform on behalf of said public Agency all functions required of it under the Act and Regulation of the Board of Administration; and

**BE IF FURTHER RESOLVED AND ORDERED**, that the maximum employer contribution for coverage under the Act shall be effective beginning January 1, 2005, for employees in and annuitants from the non-represented Management Unit.

Resolution No.

Page 2

**PASSED AND ADOPTED** this 10<sup>th</sup> day of September 2004, by the following vote:

**AYES:** Directors -

**NOES:** Directors -

**ABSTAIN:** Directors -

**ABSENT:** Directors -

**APPROVED** \_\_\_\_\_

EMILY REILLY  
Chairperson

**A T T E S T** - - \_\_\_\_\_  
LESLIE WHITE  
Secretary/General Manager

**APPROVED AS TO FORM:**

\_\_\_\_\_  
MARGARET GALLAGHER  
District Counsel

5-15.a2

BEFORE THE BOARD OF DIRECTORS OF THE  
SANTA CRUZ METROPOLITAN TRANSIT DISTRICT

Resolution No. \_\_\_\_\_  
On the Motion of Director: \_\_\_\_\_  
Duly Seconded by Director: \_\_\_\_\_  
The Following Resolution is Adopted:

**A RESOLUTION OF THE  
SANTA CRUZ METROPOLITAN TRANSIT DISTRICT  
FIXING THE CONTRIBUTION UNDER THE PUBLIC EMPLOYEES' MEDICAL AND  
HOSPITAL CARE ACT FOR THE SERVICE EMPLOYEES INTERNATIONAL UNION  
LOCAL 415**

**WHEREAS**, Government Code Section 22825.6 provides that a local agency contracting under the Public Employees' Medical and Hospital Care Act shall fix the amount of the employer's contribution at an amount not less than the amount required under Section 22825 of the Act: and

**WHEREAS**, Santa Cruz Metropolitan Transit District, hereinafter referred to as Public Agency, is a local agency contracting under the Act for participation by members represented by the Service Employees International Union Local 4 15 who are employees and annuitants of the agency;

**NOW, THEREFORE, BE IT RESOLVED**, that the employer's contribution for each employee or annuitant of the Service Employees International Union Local 4 15 shall be the amount necessary to pay a portion or full cost of his/her enrollment, including the enrollment of his/her eligible family members, in a health benefits plan up to a maximum of the Blue Shield basic/supplemental premium rates based on the employee's designated category (employee only, employee plus one, family); plus administrative fees and Contingency Reserve Fund Assessments.

**BE IT FURTHER RESOLVED AND ORDERED**, that the Board of Directors appoint and direct, and it does hereby appoint and direct the Human Resources Manager to file with the Board of Administration of the Public Employees' Retirement System a verified copy of this Resolution, and to perform on behalf of said public Agency all functions required of it under the Act and Regulation of the Board of Administration; and

**BE IF FURTHER RESOLVED AND ORDERED**, that the maximum employer contribution for coverage under the Act shall be effective beginning January 1, 2005, for employees in and annuitants from the Service Employees International Union Local 415.

Resolution No.

Page 2

**PASSED AND ADOPTED** this 10<sup>th</sup> day of September 2004, by the following vote:

**AYES:** Directors -

**NOES:** Directors -

**ABSTAIN:** Directors -

**ABSENT:** Directors -

**APPROVED** \_\_\_\_\_

EMILY REILLY  
Chairperson

**A T T E S T** \_\_\_\_\_

LESLIE WHITE  
Secretary/General Manager

**APPROVED AS TO FORM:**

\_\_\_\_\_  
MARGARET GALLAGHER  
District Counsel

5-15.02

Attachment 

BEFORE THE BOARD OF DIRECTORS OF THE  
SANTA CRUZ METROPOLITAN TRANSIT DISTRICT

Resolution No. \_\_\_\_\_  
On the Motion of Director: \_\_\_\_\_  
Duly Seconded by Director: \_\_\_\_\_  
The Following Resolution is Adopted:

**RESOLUTION ELECTING TO BE SUBJECT TO  
PUBLIC EMPLOYEES' MEDICAL AND HOSPITAL CARE ACT  
ONLY WITH RESPECT TO MEMBERS OF A SPECIFIC EMPLOYEE  
ORGANIZATION  
AND**

**FIXING THE EMPLOYER'S CONTRIBUTION AT AN AMOUNT AT OR GREATER  
THAN THAT PRESCRIBED BY SECTION 22892(b)(1) OF THE GOVERNMENT CODE**

- WHEREAS, (1) Government Code Section 22922(b) provides that a contracting agency may elect upon proper application to participate under the Public Employees' Medical and Hospital Care Act with respect to a recognized employee organization only; and
- WHEREAS, (2) Santa Cruz Metropolitan Transit District, hereinafter referred to as Public Agency is a local agency contracting with the Public Employees' Retirement System; and
- WHEREAS, (3) The Public Agency desires to obtain for the members of the Paratransit employees also represented by the United Transportation Union, Local 23, who are employees and annuitants of the agency, the benefit of the Act and to accept the liabilities and obligations of an employer under the Act and Regulations; now, therefore, be it
- RESOLVED, (a) That the Public Agency elect, and it does hereby elect, to be subject to the provisions of the Act; and be it further
- RESOLVED, (b) That the employer's contribution for each employee or annuitant shall be the amount necessary to pay the full cost of his/her enrollment, including the enrollment of family members, in a health benefits plan or plans up to a maximum of the Blue Shield basic/supplemental premium rates based on the employee's designated category (employee only, employee plus one, family) plus administrative fees and Contingency Reserve Fund assessments; and be it further

RESOLVED, (c) That the executive body appoint and direct, and it does hereby appoint and direct, Leslie White, General Manager to file with the Board of Administration of the Public Employees' Retirement System a verified copy of this Resolution, and to perform on behalf of said Public Agency all functions required of it under the Act and Regulations of the Board of Administration; and be it further

RESOLVED, (d) That coverage under the Act be effective on November 1, 2004.

**INSTRUCTIONS -- RESOLUTION ELECTING EQUIJAL CONTRIBUTIONS**

This resolution form is the approved form designated by the Public Employees' Retirement System. It should be used by a Public Agency to assure proper filing with the Public Employees' Retirement System for the combined purpose of:

1. Contracting for coverage under the Public Employees' Medical and Hospital Care Act, for one employee organization, and
2. Fixing the employer's contribution at an amount at or greater than that prescribed in GC 22892(b)(1).

WHEREAS (2) should be completed with the Public Agency name.

WHEREAS (3) should be completed with the employee organization name. Annuitant refers to retired employees and their survivors who receive a retirement allowance, as defined in Section 22760.

RESOLVED (b) should be completed to specify the amount of the employer's (agency's) contribution toward the cost of its employees' or annuitants' enrollments. The amount specified by this Resolution would be an amount equal to or greater than that specified in Section 22892(b)(1) as authorized by Section 22892(a) of the Government Code. Minimum employer contributions as prescribed in Section 22892(b)(1) is as follows:

|      |         |
|------|---------|
| 2003 | \$16.00 |
| 2004 | \$32.20 |
| 2005 | \$48.40 |
| 2006 | \$64.60 |
| 2007 | \$80.80 |
| 2008 | \$97.00 |

Section 22892(a) of PEMHCA provides that a local contracting agency may fix the amount of the employer's contribution from time to time by resolution. The amount shall not be less than

5-15.c2

the amount required under Section 22892(b)(1). The resolution will be effective on the first day of the second month following the month in which the resolution is received.

RESOLVED (c) requests the position title of the individual who handles the Public Employees' Retirement System contract for the Public Agency.

RESOLVED (d) provides that if a Resolution is filed in the office of the Board **on or before the tenth day of any month**, the coverage is to become effective on the first of the following month.

**Because resolutions serve as our legal contract we require either the original resolution, certified copy with original signatures or a copy of the resolution with the agency's raised seal.**

The certification shown following the Resolution is to be completed by those individuals authorized to sign for the Public Agency in legal actions and is to include the name of the executive body; i.e., Board of Directors, Board of Trustees, etc., the location and date of signing.

**PASSED AND ADOPTED** this 10<sup>th</sup> day of September 2004, by the following vote:

**AYES:** Directors -

**NOES:** Directors -

**ABSTAIN:** Directors -

**ABSENT:** Directors -

**APPROVED**

\_\_\_\_\_  
EMILY REILLY  
Chairperson

**ATTEST**

\_\_\_\_\_  
LESLIE WHITE  
Secretary/General Manager

**APPROVED AS TO FORM:**

\_\_\_\_\_  
MARGARET GALLAGHER  
District Counsel

5-15.c3

# SANTA CRUZ METROPOLITAN TRANSIT DISTRICT

**DATE:** September 24, 2004

**TO:** Board of Directors

**FROM:** Robyn D. Slater, Human Resources Manager

**SUBJECT: CONSIDERATION OF MODIFICATION TO CURRENT CLASS SPECIFICATION (JOB DESCRIPTION) OF THE PARTS CLERK TO REPLACE THE CLASS B DRIVER'S LICENSE REQUIREMENT WITH A CLASS C DRIVER'S LICENSE REQUIREMENT**

## I. RECOMMENDED ACTION

**It is recommended that the Board of Directors approve the removal of the requirement for a class B driver's license for the Parts Clerk position and instead require a class C driver's license. The position will then conform with the other position in the job class.**

## II. SUMMARY OF ISSUES

- Very few candidates applied for the Parts Clerk position last time a recruitment was conducted.
- None of the other positions in that job class, Receiving Parts Clerk, Lead Parts Clerk and the Supervisor of Parts and Materials are required to have a class B driver's license.
- The Fleet Manager has stated there is not a departmental need for a class B license.

## III. DISCUSSION

As a result of vacancies, recruitment for the Parts Clerk position has occurred twice within the last two years. METRO received a small number of applications for each recruitment. Eliminating the need for a class B license may increase the number of qualified applicants" Management has discussed this change with Union representatives who agree with the proposed change.

## IV. FINANCIAL CONSIDERATIONS

There is no cost associated with this change.

5-16.1



**V. ATTACHMENTS**

**Attachment A:** Proposed class specification (job description) for the Parts Clerk

# SANTA CRUZ METROPOLITAN TRANSIT DISTRICT

## PARTS CLERK

### DEFINITION

Under supervision, maintains the Fleet Maintenance Division parts room(s), including the requisitioning, receiving, inspecting, stocking, issuing of all materials, supplies, vehicle parts and related special equipment and tooling used in the support of the District's revenue and non-revenue vehicles; performs annual and perpetual inventory of Division parts, materials, supplies and fixed assets in accordance with District's MIS inventory control modules; performs other related duties as assigned.

### EXAMPLES OF DUTIES

Issues Fleet Maintenance Division purchase requisitions, receives, inspects and stocks all required parts, materials and supplies.

Identifies and requests parts, materials and supplies by researching catalogues, parts manuals and other available sources.

Issues parts, materials and supplies to requesting Division departments and records all transactions.

Issues the Division's specialized equipment and tooling to Division personnel.

Utilizes District's MIS program to perform daily inventory control functions, including posting of receipts, monitoring of issuances and other data maintenance.

Performs perpetual inventory of parts, materials and supplies.

Assists in vendor selection and monitoring of vendor performance.

Maintains a clean, orderly and safe parts room.

Maintains Division's specialized equipment, tooling and inventory assets and performs an annual inventory.

Delivers or pick up parts, materials and supplies from one or more locations.

May work at either the Watsonville or Santa Cruz facility as required by Division needs.

Performs duties of the Receiving Parts Clerk as required.

## EMPLOYMENT STANDARDS

### Knowledge of:

- Principles and functions of transit diesel engine operation.
- Electrical, pneumatic and hydraulic systems.
- Basic principles and practices of transit and automotive storekeeping and parts inventory methods.
- Mechanical tools, parts, supplies and related transit support equipment.

### Ability to:

- Identify mechanical tools, parts, supplies and related transit support equipment.
- Read and comprehend technical parts manuals and schematics.
- Read and legibly write English.
- Work shift, including weekdays, nights and weekends.
- Work well with others.
- Work under deadlines and schedules.
- Learn and effectively use the District's computer hardware and software.
- Make arithmetical computations rapidly and accurately on an adding machine or electronic calculator.
- Keep and maintain accurate records.
- Physical stamina to lift heavy objects and perform duties of the position.

### Training and Experience

A minimum of three years of full-time work experience as a parts clerk performing the receipt, issuance and inventory of automotive and heavy duty transit parts.

### Special Requirements

Possession of a Class-B **C** California driver's license or ability to obtain one.

Ability to be available for emergency or call-back duty, 24 hours a day, seven days a week.

5-16.92

# SANTA CRUZ METROPOLITAN TRANSIT DISTRICT

**DATE:** September 10, 2004

**TO:** Board of Directors

**FROM:** Robyn D. Slater, Human Resources Manager

**SUBJECT: CONSIDERATION OF APPROVAL OF PARATRANSIT CLASS SPECIFICATIONS (JOB DESCRIPTIONS) FOR PARATRANSIT OPERATOR, RESERVATIONIST, DISPATCH/ SCHEDULER, RESERVATION/SCHEDULING COORDINATOR, TRAINING AND ROAD RESPONSE COORDNATOR, MECHANIC II, AND SUPERINTENDENT**

## I. RECOMMENDED ACTION

**It is recommended that the Board of Directors approve the attached class specifications (job descriptions) for the Paratransit operations.**

## II. SUMMARY OF ISSUES

- In June the Board approved the transition of the Paratransit operations from a Community Bridges to an internal operation.
- In July the Board approved the contract with UTU for represented Paratransit positions.
- To meet the required deadlines District met with the Union and developed job descriptions so recruitment of internal and external candidates could begin.

## III. DISCUSSION

In July, the Board and UTU approved a contract allowing the District to begin the transition of Paratransit operations to an internal function of the District. Management and representatives of UTU met and reviewed job descriptions for positions new to METRO.

So deadlines could be met within the required deadlines for the transition of Paratransit services recruitment began in August. Current UTU members working at Community Bridges were given the opportunity to transition to employment with METRO. Simultaneously, external recruitments were conducted so candidates could be identified to insure Paratransit positions would be filed and employees trained by the November 1, 2004 deadline.

Staff is requesting your approval of these new class specifications at this time so we may proceed with the recruitment efforts.

5-17.1

#### **IV. FINANCIAL CONSIDERATIONS**

The salary ranges for these positions was approved as part of the UTU Labor Agreement and cost of staffing has already been included in the Paratransit budget.

#### **V. ATTACHMENTS**

- Attachment A:** Class specification for Paratransit Operator
- Attachment B:** Class specification for Reservationist
- Attachment C:** Class specification for Dispatch/Scheduler
- Attachment D:** Class specification for Reservation/Scheduling Coordinator
- Attachment E:** Class specification for Training and Road Response Coordinator
- Attachment F:** Class specification for Mechanic II
- Attachment G:** Class specification for Superintendent

Santa Cruz Metropolitan Transit District

**PARATRANSIT OPERATOR**

**POSITION DESCRIPTION:**

Under general supervision, is responsible for the safe operation of METRO'S equipment, alighting and boarding passengers, collects fares along a scheduled route or destination. Clerical duties as needed to gather information regarding ridership data and vehicle operation.

**DUTIES AND RESPONSIBILITIES**

Develops and maintains effective working relationships with other staff, representatives of the community, customers, and the public.

Communicates effectively and respectfully with people from different racial, ethnic, cultural groups, physical and intellectual abilities, lifestyle choices and ages.  
Demonstrates an ability to be sensitive to the needs of customers.

Thoroughly inspect assigned coach for all safety, comfort and cleanliness items prior to departing from the operations' facility. Document defects and notify Dispatcher of any damage to the vehicle.

Throughout assigned shift, safely operate coach on assigned route and schedule while picking up and delivering passengers except as altered by Dispatcher.

Uses a variety of communication systems and other automated tools to communicate with Dispatcher.

Communicates effectively and respectfully with Dispatch and other co-workers.

Collect fares and pre-paid media, inspects passenger identification for validity, and collect ridership information.

Offer assistance to passengers in boarding and alighting when necessary, and provide information to passengers, when requested. Assist and ensure that wheelchair passengers are properly secured.

May assist new and trainee operators as a line instructor.

Except for authorized relief periods, continually attend the coach to ensure the security and safety of both the coach and the passengers, and the maintenance of radio contact with dispatch and other operators.

Fuels and maintains vehicle interior cleanliness as needed.

Cleans vehicle windows as needed to maintain appropriate visibility.

At the completion of shifts ensure that passenger counts, tickets, and other data are delivered to the dispatcher and properly recorded.

Complete coach defect card. Turn into dispatcher all lost and found items.

Adhere to METRO and departmental policies and procedures.

Follows all District procedures regarding hazardous waste; follows all health and safety procedures.

Other related duties as assigned.

### **MINIMUM QUALIFICATIONS**

Safe driving practices.

Basic skills in time calculation and map reading.

Safely operate all Paratransit Vehicles.

Perform simple math calculations.

Deal courteously and effectively with the public.

Understand the problems of the elderly and handicapped and deal with them in a tactful manner.

Handle difficult and emergency situations calmly.

Read English and speak and write English clearly.

Operate mobile radio unit.

Willingness and ability to work unusual hours including nights, weekends, and holidays.

### **PHYSICAL DEMANDS:**

While performing the duties of this class, the employee is regularly required to sit; talk or hear, in person and by radio; use hands to finger, handle, feel or operate District vehicle; reach with hands or arms. The employee frequently is required to walk, bend and twist at the neck, stand, lift 30 pounds or over, assist passengers boarding and deboarding, including pushing an occupied mobility device up a vehicle ramp, stoop, crouch, and twist, as required by various job duties. Specific vision abilities required by this job include close vision and the ability to adjust focus. The employee does not work under typical office conditions. The employee will be working in Paratransit vehicles where there is a moderate noise level.

### **SPECIAL REQUIREMENTS:**

Possession of a current motor vehicle license and the ability to obtain a California Class B driver's permit with passenger endorsement prior to appointment. Driving record at date of hire must be consistent with SCMTD's standards for this position. Good attendance record in previous employment. Safe driving record. Must pass requisite background check.

Valid First aid and CPR certification

This position is considered Safety Sensitive position and is subject to Drug and Alcohol testing as required by FTA CFR 49.

5-17.02

Santa Cruz Metropolitan Transit District

**PARATRANSIT RESERVATIONIST**

**POSITION DESCRIPTION:**

Under direct supervision receives customer calls, accurately records customer reservation information in a computer based environment, provides accurate route and schedule information to the customer, responsible for post-trip data entry. Performs miscellaneous clerical and typing duties as assigned.

**DUTIES AND RESPONSIBILITIES:**

Processes customer reservation and information calls which may include providing information of outside agency services and fixed route schedules.

Negotiates pick-up schedules with customer based on geography and time of request.

Records and maintains records of daily activities.

Develops and maintains effective working relationships with other staff, representatives of the community, customers, and the public.

Communicates effectively and respectfully with people from different racial, ethnic, cultural groups, physical and intellectual abilities, lifestyle choices and ages. Demonstrates an ability to be sensitive to the needs of customers.

Gathers and maintains program statistics.

Typing, filing, computer input and word processing as well as other light clerical duties as assigned.

Adhere to METRO and departmental policies and procedures.

Uses a variety of office equipment.

**MINIMUM QUALIFICATIONS:**

Ability to interact with customers and staff in a professional manner.

Oral and written communication skills sufficient to complete paperwork, and effectively communicate with the majority of customers and co-workers.

Working knowledge of major computer software (e.g. Microsoft Office) systems.

Ability to work calmly and in emergency/crisis situations.

Fluency in Spanish is preferred.

Working knowledge of Trapeze PASS preferred.

Willingness and ability to work unusual hours including nights, weekends, and holidays.



**PHYSICAL DEMANDS**

While performing the duties of this job the employee is frequently required to sit, talk or hear, both in person and by telephone, use hands to finger, handle or feel objects or controls, reach with hands and arms. The employee is regularly required to stand, walk and twist at the neck. Occasional overhead reaching and lifting up to 30 pounds is required. Visual abilities required include close vision, distance vision, and the ability to adjust focus.

**SPECIAL REQUIREMENT:**

Good attendance record in previous employment. Must pass requisite background check.

5-17.62

Santa Cruz Metropolitan Transit District

**PARATRANSIT DISPATCH/SCHEDULER**

**POSITION DESCRIPTION:**

Under the supervision of the Reservation and Scheduling Coordinator, dispatches Paratransit Operators using a variety of communication devices. Prepares and adjusts ride manifests for Paratransit Operators and supplemental providers, monitors drivers' locations and documents drivers' adherence to ride manifests. Provides assistance with reports as instructed. Performs other functions as assigned.

**DUTIES AND RESPONSIBILITIES:**

Dispatches vans using various communication devices. Works to coordinate rides whenever possible.

Prepares drivers packets for the next day.

Administers driver sign-in and sign-out procedures.

Communicates with Paratransit Operators and customers regarding any schedule adjustments.

Uses a variety of communication systems and other automated tools to monitor paratransit operations, coordinate vehicles, and adjust schedules to optimize service delivery.

Uses judgment to resolve unusual situations or situations that occur in the field such as broken equipment, errors in pick-up or drop off locations.

Attempts to assess emergency/urgent situations and work with Reservation and Scheduling Coordinator, staff, and customers to resolve issues in a timely manner.

Develops and maintains effective working relationships with other staff, representatives of the community, customers, and the public.

Communicates effectively and respectfully with people from different racial, ethnic, cultural groups, physical and intellectual abilities, lifestyle choices and ages. Demonstrates an ability to be sensitive to the needs of customers.

Will be required to courteously assist customers using various communication devices as well as in public.

Will be required to provide information regarding all District services.

Receives and forwards customer feedback to the Reservation and Scheduling Coordinator.

5-17.01

Operates computer and software applications designed for scheduling.  
Adhere to METRO and departmental policies and procedures.

May also be required to assist reservationist as needed.

Like clerical duties as assigned.

Uses a variety of office equipment.

**MINIMUM QUALIFICATIONS:**

One year office clerical experience or equivalent.

Ability to interact with customers and staff in a professional manner.

Oral and written communication skills sufficient to complete paperwork, and effectively communicate with the majority of customers and co-workers.

Working knowledge of major computer software (e.g. Microsoft office) systems.

Ability to work calmly and in emergency/crisis situations.

Fluency in Spanish is preferred.

Working knowledge of Trapeze PASS preferred.

**PHYSICAL DEMANDS**

While performing the duties of this job the employee is frequently required to sit, talk or hear, both in person and by telephone, use hands to finger, handle or feel objects or controls, reach with hands and arms. The employee is regularly required to stand, walk and twist at the neck. Occasional overhead reaching and lifting up to 30 pounds is required. Visual abilities required include close vision, distance vision, and the ability to adjust focus.

**SPECIAL REQUIREMENT:**

This position is considered Safety Sensitive position and is subject to Drug and Alcohol testing as required by FTA CFR 49.

**Santa Cruz Metropolitan Transit District**

**RESERVATION AND SCHEDULING COORDINATOR**

**POSITION DESCRIPTION:**

Under general supervision is responsible for supervising the reservationists and dispatch/schedulers. This includes scheduling, training and update training for new and experienced employees as well as performance reviews and the enforcement of METRO's rules and regulation. Must be able to assist employees with minor software issues and current scheduling software systems. May act as a reservationist or dispatch/scheduler. May be required to develop and provide reports as needed. Performs related duties as assigned.

**DIJTIES AND RESPONSIBILITIES:**

Provides leadership and works with staff to develop and maintain a high performance, customer service-oriented work environment that supports achieving METRO's goals.

Insures all reservationists and dispatch/schedulers are able to demonstrate knowledge of the functions of the Paratransit program and how it relates to METRO's fixed route system.

Provides training to new employees to insure they have a working knowledge of the legal requirements of the Paratransit system. Also, that the employee is able to communicate this information to clients as needed.

Provides information regarding Paratransit services, which may require the use of tact, discretion, and the exercise of independent judgment in interpreting complex policies and regulations.

Communicates effectively and respectfully with people from different racial, ethnic, cultural groups, physical and intellectual abilities, lifestyle choices and ages. Demonstrates an ability to be sensitive to the needs of clients.

Trains all reservationists and dispatch/schedulers on how to place and modify reservations, and read the scheduling soft ware.

Supervises, and evaluates all reservationists and dispatch/schedulers.

Assists reservationists and dispatch/schedulers with any problems related to service, and works with the Training and Road Response Coordinator to make sure paratransit service is available as required.

Is able to assess emergency/urgent situations and work with staff and clients to resolve issues in a timely manner.

Uses a variety of communication systems and other automated tools to monitor paratransit operations, coordinate vehicles, and adjust schedules to optimize service delivery.

May be required to coordinate 9 11 responses in cooperation with local governmental agencies.

Compiles statistics and prepares a variety of program related reports and records.

Receives and solicits information and maintains records regarding vehicle accidents; ensures that proper reports are filed in a timely manner.

Assists Paratransit Operators in the event of mechanical and passenger related problems.

Investigates complaints and prepares related reports

Monitors field operations and communicates with maintenance and other departments as needed.

May review, approve, deny and record time off requests in compliance with labor agreement.

May participate in interviews for Paratransit Operators.

Counsels direct reports and makes recommendations to management on disciplinary actions.

Testifies at disciplinary hearings as necessary.

Must be willing to attend and satisfactorily complete additional specialized training as required by METRO.

**MINIMUM QUALIFICATIONS:**

Three (3) years experience as a dispatch or reservationist in a transportation environment and/or equivalent experience

And

One (1) year of supervisory experience

Experience preparing and conducting training programs

Ability to interact with clients and staff in a professional manner

Oral and written communication skills sufficient to complete paperwork, effectively communicate with the majority of clients and to train reservationists and dispatch/schedulers

Working knowledge of standard office software (i.e. Microsoft Office) systems.

5-17.d2

Ability to work calmly and in emergency/crisis situations  
Knowledge of Trapeze PASS software preferred  
Fluency in Spanish is preferred.  
Knowledge of FTA rule 49 CFR, parts 37 and 38 preferred  
California Class B license preferred

**SPECIAL REQUIREMENT:**

This position is considered Safety Sensitive position and is subject to Drug and Alcohol testing as required by FTA CFR 49.

Rev: July 27, 2004, Paratransit Reservation and Scheduling Coordinator

5-17.d3

**Santa Cruz Metropolitan Transit District**

**PARATRANSIT TRAINING AND ROAD RESPONSE  
COORDINATOR**

**POSITION DESCRIPTION:**

Under general supervision is responsible for all phases of training Paratransit Operators, including preparing Paratransit Operator Trainees for promotion to Paratransit Operators. Develops and presents training material in compliance with state and federal rules and regulations including the maintenance of Class B licenses for Paratransit Operators. Responsible for supervising the Paratransit Operators. Will also be responsible for responding to road emergencies and to assist Paratransit Operators in the scope of their duties. May be required to develop and provide reports as needed. Additional duties as assigned.

**DUTIES AND RESPONSIBILITIES:**

Provides leadership and works with staff to develop and maintain a high performance, customer service-oriented work environment that supports achieving METRO's goals.

Communicates effectively and respectfully with people from different racial, ethnic, cultural groups, physical and intellectual abilities, lifestyle choices and ages. Demonstrates an ability to be sensitive to the needs of clients.

Provides training to Paratransit Operator Trainees so they will have the skills and knowledge necessary for promotion to the Paratransit Operator position.

Insures all Paratransit Operator Trainees are able to demonstrate knowledge of Passenger Awareness, and can safely and efficiently secure passengers, including wheelchair tie-downs.

Coordinates, plans, and conducts training and retraining programs for Paratransit Operators in conformance with state and federal guidelines and regulations; develops, revises and updates curriculum, forms, and tests used in training.

Maintains certification for testing employees for Class B driver's license; coordinates, revises, updates, and monitors pull notices, employer statement for testing, and certifies Paratransit Operators for licensing.

Participates in the development, revision, and update of occurrence procedures and accident investigation procedures; reviews completed accident reports and identifies patterns; maintains records of Paratransit accidents; prepares monthly summary report and accidents; and coordinates the accident review process.

Instructs, supervises and evaluates new employees and Paratransit Operators during training periods.

May ride with Paratransit Operators and trainees to assess unusual or difficult loading situations and make recommendations to clients and/or Paratransit Operator/trainee on the safest and most efficient way to board a Paratransit vehicle in the future.

Is responsible for operator retraining.

Plans, develops and organizes the vehicle related portions of the division activities to provide maximum service in a cost effective manner while meeting funding guidelines and regulatory requirements. Designs and implements program management systems in areas such as vehicle maintenance and repairs and accident reporting. Develops preventative maintenance and repair schedules and ensures that they are followed in an efficient, cost-effective manner. Reviews operator reports of defects and communicates with operators to determine maintenance and repair needs, receives and responds to written feedback in the results of shop repairs and service. Maintains service and repair records. Monitors and schedules vehicle maintenance.

Ensures that all vehicle comply with all relevant safety codes and that all required safety equipment is on board and in proper working condition.

Monitors in-field operations and communicates with maintenance and other departments as needed.

Must be fully qualified as a Paratransit Operator.

May participate in interviews for Paratransit employees.

Counsels Paratransit Operators.

Testifies at disciplinary hearings as necessary.

Must be willing to attend and satisfactorily complete additional specialized training as required by METRO.

Adhere to METRO and departmental policies and procedures.

**MINIMUM QUALIFICATIONS:**

- Knowledge of supervisory techniques.
- Demonstrable knowledge of California State driving rules and regulations.
- Experience preparing and conducting training programs
- Understanding of the function of Paratransit program.
- Ability to interact with clients and staff in a professional manner
- Oral and written communication skills sufficient to complete paperwork, effectively communicate with the majority of clients and to train Paratransit Operator Trainees.
- Working knowledge of major computer software (i.e. Microsoft office) systems.

5-17.e2



Fluency in Spanish is preferred.

**PHYSICAL REQUIREMENTS:**

While performing the duties of this job the employee is frequently required to sit, talk or hear, both in person and by telephone, use hands to finger, handle or feel objects or controls, reach with hands and arms. The employee is regularly required to stand, walk bend and twist at the neck, lift 30 pounds or over, assist passengers boarding and deboarding, including pushing an occupied mobility device up a vehicle ramp.

Occasional lifting and overhead reaching is required.

Visual abilities required include close vision, distance vision, and the ability to adjust focus.

**SPECIAL REQUIREMENT:**

Possession of a current motor vehicle license and the ability to obtain a California Class B driver's permit with passenger endorsement prior to appointment. Driving record at date of hire must be consistent with SCMTD's standards for this position. Good attendance record in previous employment. Safe driving record. Must pass requisite background check.

Valid First Aid and CPR certification.

This position is considered Safety Sensitive position and is subject to Drug and Alcohol testing as required by FTA CFR 49.

**Santa Cruz Metropolitan Transit District**

**PARATRANSIT MECHANIC II**

**POSITION DESCRIPTION:**

Under the general supervision, performs skilled work in maintaining and repairing Paratransit vehicles (such as vans, cars and small buses); performs other related work as required.

**DUTIES & RESPONSIBILITIES:**

Develops and maintains effective working relationships with other staff, representatives of the community, customers, and the public.

Communicates effectively and respectfully with people from different racial, ethnic, cultural groups, physical and intellectual abilities, lifestyle choices and ages. Demonstrates an ability to be sensitive to the needs of customers.

Arranges for and performs routine maintenance, servicing, and repairs of a fleet of vehicles.

Diagnoses mechanical defects in vehicles and evaluates the nature of repairs needed.

Performs tune-ups, compression tests, and engine tuning.

Regularly services, changes fluids and lubricates vehicles.

Road tests vehicles.

May respond to vehicle breakdown and accident scenes.

Performs safety inspections of fleet.

Arranges for services and/or repairs by outside vendors as required.

Establishes and maintains cooperative and professional working relationships with outside vendors and suppliers.

Uses a wide variety of test equipment, hand and power tools, and shop equipment;

Cleans inside and outside of vehicles including biohazards;

Maintains records of work performed, mileage reports and other related vehicle records.

Maintains a clean, safe and organized work area.

Maintains parts inventory

Performs light clerical duties as it relates to their position, such as data entry.

Fuels vehicles.

Follows all District procedures regarding hazardous waste.

Follow all health and safety procedures.

Adhere to METRO and departmental policies and procedures.

### **MINIMUM QUALIFICATIONS:**

Two years full-time paid experience performing automotive repair work.

OR

A graduate of a suitable automotive maintenance training program and six months automotive repair work.

Basic principles and practices of automotive engine operation.

Basic procedures used in servicing of automotive vehicles.

Safe mechanical work practices.

The ability to read and comprehend technical manuals and schematics.

Safe driving record.

Oral and written communication skills sufficient to complete paperwork and effectively communicate with co-workers.

Available to work shifts including weekdays, nights and weekends.

### **PHYSICAL DEMANDS**

While performing the duties of this job the employee is frequently to continuously required to reach above, at and below shoulder height, bend at both the waist and neck, use hands to finger, handle or feel objects or controls. The employee is regularly required to stand, walk, kneel, crouch, and twist at the neck. Occasional pushing, pulling, lifting up to 40 pounds is required. Rarely lifting up to 80 pounds, climbing and balancing. Visual abilities required include close vision, distance vision, and the ability to adjust focus.

### **SPECIAL REQUIREMENTS**

Possession of a current motor vehicle license and the ability to obtain a California Class B driver's permit with passenger endorsement prior to appointment. Driving record at date of hire must be consistent with SCMTD's standards for this position. Good attendance record in previous employment. Safe driving record. Must pass requisite background check.

Must possess or obtain the tools necessary to perform the duties of the position, and a rollaway tool box.

5-17.f2

This position is considered Safety Sensitive position and is subject to Drug and Alcohol testing as required by FTA CFR 49.

REV: July 27, 2004, Paratransit Mechanic II

5-17.f3

**Santa Cruz Metropolitan Transit District**

**PARATRANSIT SUPERINTENDENT**

**POSITION DESCRIPTION:**

Under general direction, plans, organizes and manages delivery of assigned elements of METRO's Demand response system. Ensures Paratransit employees meet system performance and customer service standards; ensures Paratransit employees comply with Americans with Disabilities Act regulations as well as any related internal policies and procedures; performs related duties as assigned.

**DUTIES AND RESPONSIBILITIES:**

Provides leadership and works with staff to develop and maintain a high performance, customer service-oriented work environment that supports achieving METRO's goals.

Communicates effectively and respectfully with people from different racial, ethnic, cultural groups, physical and intellectual abilities, lifestyle choices and ages. Demonstrates an ability to be sensitive to the needs of clients.

Participates in establishing operational plans and initiatives to meet department goals and objectives and works to achieve overall departmental performance results.

Insures METRO's Paratransit operation complies and is consistent with American with Disabilities Act regulations.

Participates in developing and monitoring performance against the annual departmental budget.

Works with Paratransit Manager to develop performance requirements.

Uses communication devices, equipment to provide advice and assistance on how to handle difficult, sensitive or potentially dangerous situations as they arise.

Ensures staff conformance with District rules and regulations, including the Drug and Alcohol Policy, as well provisions of labor contracts and agreements.

Participates in the resolution of employee concerns and grievances; makes standard interpretations of labor contract provisions to supervisors and/or staff.

Evaluates employee attendance, performance and other issues; makes recommendations on discipline as required.

Participates in interviews for Paratransit staff.

5-17-91

Prepares and maintains department records and reports, including payroll, attendance and system performance statistics; responds to questions from the public in person and by telephone.

Must be willing to attend and satisfactorily complete additional specialized training as required by METRO.

Will be on call for accident investigation and for response to urgent and/or sensitive situations 24x7.

May monitor in-field operations and communicates with maintenance and other departments as needed.

May participate in training of employees.

May operate METRO equipment for the purpose of operator training or in emergency situations.

**MINIMUM QUALIFICATIONS:**

Any combination of training and experience equivalent to:

Two (2) years college level course work in management, business or related field. Experience that demonstrates substantial knowledge and abilities pertinent to the specific job functions may be substituted for the education requirement.

and

Two (2) years professional experience in transportation operations

and

Two (2) years supervisory experience.

Understanding of the function of Paratransit program.

Ability to interact with clients and staff in a professional manner.

Oral and written communication skills sufficient to complete paperwork, effectively communicate with the majority of clients and to train Paratransit Operator Trainees.

Working knowledge of standard office software (e.g., Microsoft Office) systems.

Fluency in Spanish is preferred.

Knowledge of FTA rule 49 CFR, parts 37 and 38 preferred.

California Class B license preferred.

**PHYSICAL DEMANDS**

While performing the duties of this job the employee is frequently required to sit, talk or hear, both in person and by telephone, use hands to finger, handle or feel objects or controls, reach with hands and arms. The employee is regularly required to stand, walk and twist at the neck. Occasional overhead reaching is required.

5-17.92

Visual abilities required include close vision, distance vision, and the ability to adjust focus.

**SPECIAL REQUIREMENT:**

This position is considered Safety Sensitive position and is subject to Drug and Alcohol testing as required by FTA CFR 49.

# SANTA CRUZ METROPOLITAN TRANSIT DISTRICT

## NOTICE OF ACTION TAKEN IN CLOSED SESSION MEMORANDUM

DATE: September 10, 2004

TO: Board of Directors

FROM: Margaret Gallagher, District Counsel

SUBJECT: Notification Of Actions Taken In Closed Session Regarding The Following  
Claims On The Dates Indicated:

Settlement with Guillermo Chavez on June 24, 2004

---

### Settlement with Guillermo Chavez

On June 24, 2004, in closed session you authorized a full and final settlement of the litigation matter, Chavez, et al v. Santa Cruz Metropolitan Transit District, et al; Santa Cruz Superior Court Case No. CV140478 in the amount of ten thousand dollars (\$10,000.00), for a Personal Injury, Employment and Civil Rights Violation complaint filed against METRO and several METRO employees on March 16, 2001. The following Directors authorized the settlement: Beautz, Hinkle, Keogh, Reilly, Skillicom, Stone, Spence and Tavantzis. Directors Ainsworth, Norton and Rotkin were absent. Pursuant to this direction, a fully executed release was received from the litigant and his attorney. District warrants were issued and a Dismissal with Prejudice was entered in the Santa Cruz Superior Court on August 20, 2004.



BEFORE THE BOARD OF DIRECTORS OF THE  
SANTA CRUZ METROPOLITAN TRANSIT DISTRICT

Resolution No. \_\_\_\_\_

On the Motion of Director:

Duly Seconded by Director: \_\_\_\_\_

The Following Resolution is adopted:

**A RESOLUTION OF  
APPRECIATION AND REMEMBRANCE FOR THE SERVICES OF  
BART CAVALLARO AS A MEMBER OF THE BOARD OF DIRECTORS  
FOR THE SANTA CRUZ METROPOLITAN TRANSIT DISTRICT**

**WHEREAS**, the Santa Cruz Metropolitan Transit District was formed to provide public transportation to all of the citizens of Santa Cruz County, and

**WHEREAS**, the provision of public transportation service requires a dedicated policy board, and

**WHEREAS**, the City of Scotts Valley, requiring a representative with expertise, commitment, and dedication appointed Bart Cavallaro to serve in the position of Director, and

**WHEREAS**, Bart Cavallaro served as a member of the Board of Directors of the Santa Cruz Metropolitan Transit District for the time period of 1981 to 2000 including serving as Chair in 1984, 1991, and 1992, and

**WHEREAS**, Bart Cavallaro provided the Santa Cruz Metropolitan Transit District with dedicated service, guidance, and leadership during his terms of office, and

**WHEREAS**, Bart Cavallaro served the Santa Cruz Metropolitan Transit District with distinction, and

**WHEREAS**, the service provided to the citizens of Santa Cruz County by Bart Cavallaro resulted in safe, reliable, quality public transportation being available in the most difficult of times, and

**WHEREAS**, during the time that Bart Cavallaro served in the position of Director, METRO expanded service, developed new facilities, purchased new equipment, improved ridership, and enhanced the alternative transportation options for the citizens of Santa Cruz County, and

**WHEREAS**, the quality of life in Santa Cruz County was improved dramatically as a result of the exemplary service, tireless support, and unwavering leadership provided by Bart Cavallaro and,

**WHEREAS**, Bart Cavallaro passed away on August 31, 2004.

5-19.1

**NOW, THEREFORE, BE IT RESOLVED**, that in recognition of service and commitment, the Board of Directors of the Santa Cruz Metropolitan Transit District does hereby posthumously commend Bart Cavallaro for efforts in advancing public transit service in Santa Cruz County and expresses sincere appreciation on behalf of itself, METRO staff and all of the citizens of Santa Cruz County.

**BE IT FURTHER RESOLVED**, that a copy of this resolution be presented to the Family of Bart Cavallaro and that a copy of this resolution be entered into the official records of the Santa Cruz Metropolitan Transit District.

**PASSED AND ADOPTED** this \_\_\_\_\_ day of \_\_\_\_\_ by the following vote:

**AYES:**

**NOES:**

**ABSTAIN:**

**ABSENT:**

**APPROVED** \_\_\_\_\_ - -

Emily Reilly  
Chairperson

**ATTEST** \_\_\_\_\_

LESLIE R. WHITE  
General Manager

**APPROVED AS TO FORM:**

\_\_\_\_\_  
MARGARET GALLAGHER  
District Counsel

5-19.2

# SANTA CRUZ METROPOLITAN TRANSIT DISTRICT

**DATE:** September 24, 2004  
**TO:** Board of Directors  
**FROM:** Robyn Slater, Human Resources Manager  
**SUBJECT: PRESENTATION OF EMPLOYEE LONGEVITY AWARDS**

## I. RECOMMENDED ACTION

**Staff recommends that the Board of Directors recognize the anniversaries of those District employees named on the attached list and that the Chairperson present them with awards.**

## II. SUMMARY OF ISSUES

- None.

## III. DISCUSSION

Many employees have provided dedicated and valuable years to the Santa Cruz Metropolitan Transit District. In order to recognize these employees, anniversary awards are presented at five-year increments beginning with the tenth year. In an effort to accommodate those employees that are to be recognized, they will be invited to attend the Board meetings to receive their awards.

## IV. FINANCIAL CONSIDERATIONS

None.

## V. ATTACHMENTS

**Attachment A:** Employee Recognition List

**SANTA CRUZ METROPOLITAN TRANSIT DISTRICT**  
**EMPLOYEE RECOGNITION**

**TEN YEAR**

None

**FIFTEEN YEARS**

A. John Daugherty, Accessible Services Coordinator

**TWENTY YEARS**

None

**TWENTY-FIVE YEARS**

Michael T. Steber, Bus Operator

**THIRTY YEARS**

Roy G. Brogdon, Supervisor of Revenue Collection

**Draft**

**Paratransit Coordination Task Force  
Minutes - Meeting # 3**

August 18, 2004, 2:00 to 5:00 pm

ABC Rooms of the Santa Cruz Civic Auditorium

**Members Present:**

Michael Bradshaw  
Scott Bugental  
Richard Camperud  
Barbara Flynn  
Kathleen Johnson  
Clay Kempf  
Paul Marcelin-Sampson  
Roger McKowan  
Eileen Pavlik  
Dennis Papadopulo  
Emily Reilly  
Carmen Robles  
Ernestina Saldana  
Pat Spence  
Ellen Timberlake  
Adam Tomaszewski  
Arturo Zamudio

**Alternates Present (\* = voting):**

Kirk Ance \*  
Manual Coto \*  
Steve Kudlak \*  
James Monroe  
Bonnie Morr  
Andy Schiffrin

**Staff Present:**

Bryant Baehr, Metro  
Robyn Brown, Yellow Cab  
Peggy Gallagher, Metro  
Steve Paulson, Metro  
Karena Pushnik, SCCRTC  
Tegan Speiser, SCCRTC  
Link Spooner, Community

**Bridges**

Sam Storey, Community Bridges  
Les White, Metro

**Others/Guests Present:**

Barbara Jackson  
Trudy Jackson

**1. Introductions**

Attendees introduced themselves.

**2. Oral Communications**

Barbara Jackson suggested that Lift Line services include reasonable accommodation for hearing impaired individuals and that information about this disability be included in computer records for clients. She also asked that Metro and ADA materials be mailed rather than only available at transit centers.

Paul Marcelin-Sampson announced that Pat Spence would arrive tardy due to a late ride pick up.

Dennis Papadopulo requested that something be done for his wheelchair-using friend in the Pleasant Care facility who has a difficult time visiting his mother because she lives ¼ mile past the bus stop. This item was discussed further with the ADA Paratransit Service item.

Karena Pushnik distributed an updated draft of the Existing Services matrix noting that the chart will continue to be updated as new information becomes available.

Mardi Wormhoudt said that she has had many conversations with people about paratransit issues and reminded attendees that the Task Force had come about to try to address practical problems. She expressed hope that the Task Force can help create a plan that provides efficient, effective and compassionate transportation services. She asked members to set aside bad feelings, mistrust and frustration, and use their talents to look toward the future and the long term.

### **3. Additions/Deletions to the Agenda**

Karena Pushnik distributed additional materials for Item #5.

Pat Spence requested that future agendas include consent and regular agendas so that items that are not discussed can still be formally accepted. There was no objection.

Ms. Spence also asked why the minutes, Item #4, included the Goals/Issues and Work plan when they were also attached to Item # 5. They were considered in Item #5.

### **4. Approve Minutes of June 16, 2004 Paratransit Task Force Meeting**

(Kempf/Robles, with 1 abstention and 2 no votes to Attachment 1) - Approved the minutes with the following amendments:

- Change IHHS to IHSS defined as In Home Support Services
- Add Bryant Baehr to the list of attendees

Paul Marcelin-Sampson distributed his assessment of changes to Attachment 1, the presentation by Paratransit Inc and additional research he has conducted.

### **5. Mandates and Program Changes**

Mardi Wormhoudt provided an overview and explained that planned changes in the provision of ADA Paratransit services warranted discussion and thus a deviation from the work plan. Karena Pushnik described the background materials on legal requirements were provided in the packet about ADA Paratransit, Medi-Cal and the Consolidated Transportation Service Agency.

Additional materials about the Volunteer Center, Cabrillo College and UCSC specialized transportation program requirements were distributed at the meeting.

Emily Reilly requested that the Task Force do its best to move forward as a group reminding the attendees that regardless of who provides the rides, the goal is to provide the best service for the people that need it. She noted that she has been given unanimous direction from the transit board to find out about people's fears, issues and problems, and find solutions. She encouraged people to be forthright and to express their ideas about ways to build trust.

Scott Bugental cited the adage "actions speak louder than words" and requested that the transit board follow through with expressed community interests.

Adam Tomaszewski felt confident that, once the programs are separate, complaints could be better directed to separate agencies (Community Bridges and Metro). He also noted that seniors are currently confused about the future of specialized transportation to meet their needs.

Mardi Wormhoudt asked whether there were changes to the Work Plan and Goals/Issues. There were none.

Bryant Baehr provided an overview of the ADA Paratransit/ParaCruz transition plan and distributed a list of Frequently Asked Questions (FAQs). He noted that: operation of ParaCruz will be fully transitioned to Metro on November 1; space has been leased at 2880 Research Park Drive; transition agreements have been made with the drivers union representing both Metro and Community Bridges; a transition agreement is in place with Community Bridges; Requests for Proposals are out for supplemental service providers (assuming that 1-2 providers will carry 20-30% of the rides), a new telephone system and a mobile communication system; a seamless phone connection between the two agencies has been planned; three new larger vehicles will arrive soon; nineteen vans in storage are being prepared for service; Community Bridges drivers can apply for ParaCruz positions; and a letter has been sent to current clients with information and the new phone number. The plan is to contact current ParaCruz clients a total of three times between now and November. The only update needed to the current ParaCruz Guide (policies and procedures) is the new phone number.

Kathleen Johnson asked what kind of outreach will be provided to 38 residential care facilities and 10 skilled nursing care facilities. Bryant answered that Metro plans to provide information in September to the primary trip generators for ParaCruz.

Michael Bradshaw expressed concern that people who don't read, have cognitive disabilities, use TTY, speak Spanish, etc will have a hard time getting the needed information.

Ellen Timberlake wondered why a supplemental service provider is necessary. Bryant noted that it can be more cost effective to have private operators provide service early in the morning, late at night or on weekends.

Adam Tomaszewski requested that the FAQs for ParaCruz also include information about Community Bridges programs. Bryant suggested that the FAQs for both Community Bridges and ParaCruz be combined for the next wave of outreach to avoid confusion. Sam Storey noted that dispatch operators have also been instructed to provide information about the changes in services.

Michael Bradshaw asked whether the funding for any of the other types of specialized transportation services would be affected by the ParaCruz transition. Bryant answered that he didn't think so.

Clay Kempf wondered whether the several hundred thousand dollar operating deficit experienced by Community Bridges in FY 2002-03 can be paid back by Metro now that Community Bridges will no longer be providing ADA Paratransit services. Sam Storey indicated that Community Bridges will benefit financially by not providing ADA paratransit services and that they may be able to provide more community rides. Bryant answered that Metro had a competitively bid contract with Community Bridges for service and that Metro is not responsible for the deficit.

Sam Storey noted that a possible unintended consequence of the new operations configuration is that private operator and driver availability capacity could be affected. In addition, there could be potential impacts on other services.

Mardi Wormhoudt asked whether a greater percent of service will now be delivered by independent contractors. Bryant answered that currently 55-60% of ParaCruz service is subcontracted to private operators and estimates are that in the future private operators will carry 20-30% of all ParaCruz rides. Mardi also asked whether there will be a net increase in jobs, and both Sam and Bryant answered that they thought it there would be a net increase in jobs.

Tegan Speiser asked for clarification about the total number of ParaCruz clients. Bryant answered that there are 3,600 people in the database and 1,000 frequent users, averaging about 230 trips per day.



Scott Bugental requested clarification about the future of an existing policy that allowed people a ride home if they couldn't pay. Bryant answered that Metro will make every attempt to avoid stranding people, but will be sensitive to patterns. Les White noted that it is likely that staff will make recommendations to the Metro Board at their August, September and October meetings about various ParaCruz policy issues.

Sam Storey provided a presentation about the transition plan from Community Bridges' perspective referring to the FAQs included in the packet. He stated that the approximately 100,000 annual non-ADA rides (Alliance/Medi-Cal, Senior Meal Site, Elderday, TDA, etc.) will continue and that Community Bridges will strive to fill unmet needs in the community beyond ADA Paratransit.

Clay Kempf asked whether Metro intended to pursue funding sources currently used by Community Bridges. Bryant answered that they are currently focused on complying with the law and transitioning ADA ParaCruz and that no other commitments can be provided. The Metro board has not discussed this topic.

Andy Schiffrin asked whether rides will be provided for trips originating outside the ParaCruz service area and whether it will be a connection to ParaCruz or a continuous ride. Sam responded that TDA funds are not sufficient to fulfill requests for all trips throughout the county and, thus far, has focused on medically necessary rides. Bryant will look into the current practice of people getting on and off the vehicle at the service area border and related future policies. Paul Marcelin-Sampson wondered whether Metro perceived an equity difference between bus riders transferring and paratransit riders transferring.

***Karena Pushnik will research kinds of contractual/cost sharing arrangements that exist in other areas of the state for rides connecting to ADA Paratransit.***

Some attendees provided the suggestions to Metro and Community Bridges to assist with the transition of ADA ParaCruz operations (Attachment 1). ***Both agencies will provide a response to these suggestions to be included in the next Task Force meeting packet.***

***The committee decided to postpone the Metro Legal Mandates portion of this item to the next month's agenda due to the lack of time.***

## **6. Upcoming Unmet Paratransit/Transit Needs Public Hearing**

Karena Pushnik provided an overview of the purpose of defining Unmet Paratransit and Transit Needs, noting their function as both short and long range needs. She noted that input was received from the Elderly & Disabled

Transportation Advisory Committee, Santa Cruz Metropolitan Transit District, Metro Advisory Committee and the Metro Accessible Services Transit Forum to develop a draft list of needs. The Regional Transportation Commission will hold a public hearing on this topic during their September 2 meeting at 9:30 am at the County Government Center to receive additional testimony.

Mardi Wormhoudt asked attendees whether an integrated system run by one agency might be more efficient in the long term. Many agreed with that vision but would need to know more about the financial implications. A long term integration goal with phased interim goals could be a good approach. *The group agreed to work toward a definition or vision of what success would look like.*

#### **7. Review Specialized Transportation Program/CTSA Structure in Other California Communities – Continued from 6/16/04 meeting**

This item was again continued.

#### **8. Accept Information Items**

- a. Updated Draft Matrix of Existing Services
  - This item was distributed earlier in the meeting.
  - *Information items from the 6/16 agenda were requested to be included in the September agenda: Disability and age data from 2000 census, Projections through 2050 of people over 65 in Santa Cruz County*

#### **7. Confirm Next Meeting**

- a. The next meeting date and time & place was confirmed:  
Wednesday, September 15, 2004 from 2:00 – 5:00pm at the Santa Cruz Civic Auditorium, ARC Room, 307 Church Street, Santa Cruz.
- b. Agenda Items:  
Chair Wormhoudt confirmed that the next meeting would focus on: 1) Legal mandates for both Metro and Community Bridges; 2) Response to suggestions for ParaCruz service; and 3) Customer Service and Satisfaction

#### **8. Adjourn**

The meeting adjourned at 5:00 pm.

*Respectfully submitted by:*

*Karena Pushnik, SCCRTC Staff*

\\Rtcserv1\Internal\NE&DTAC\Paratransit\Task Force\Meetings\Aug04\Minutes0804.doc

# SANTA CRUZ METROPOLITAN TRANSIT DISTRICT

**DATE:** September 10, 2004

**TO:** Board of Directors

**FROM:** Frank L. Cheng, Project Manager

**SUBJECT: CONSIDERATION OF AUTHORIZING THE GENERAL MANAGER TO EXECUTE A CONTRACT TO PURCHASE A VERTICAL LNG STORAGE TANK FOR AN LCNG FUELING STATION FOR THE METROBASE PROJECT**

## I. RECOMMENDED ACTION

**That the Board of Directors authorize the General Manager to execute a contract for the purchase of Vertical LNG Storage Tank for an LCNG Fueling Station for the MetroBase Service Facility.**

## II. SUMMARY OF ISSUES

- In order to assure the completion of the MetroBase Fueling Station in time to meet the requirements of the California Act Resource Board (CARB), METRO is proposing to purchase fueling station components that have a long lead time for delivery in advance of awarding a General Construction Contract.
- On July 22<sup>nd</sup>, 2004, Santa Cruz METRO sent out an Invitation for Bids For Purchase of Vertical LNG Storage Tank for the LCNG Fueling Station that is a part of the MetroBase Project.
- On August 23<sup>th</sup>, 2004, METRO received two bids from NexGen Fueling, a division of Chart Industries, and Taylor-Wharton.
- METRO has completed the Cost/Price Analysis necessary to meet federal requirements and determined that the bid price is justified.

## III. DISCUSSION

The MetroBase Project consists of three sections; Operations Building, Maintenance Building, and Service Building. Due to the CARB requirements, the Service Building will require items that are long lead items to be purchased in advance of the General Construction Contract. One of the items is a Vertical LNG Storage Tank for the LCNG Fueling Station.

On July 22<sup>nd</sup>, 2004, Santa Cruz METRO sent out an Invitation for Bids For Purchase (IFB) of a Vertical LNG Storage Tank for the LCNG Fueling Station. At the end of the 30 day bid period, METRO received two bids, one from NexGen Fueling, a division of Chart Industries, and the other from Taylor-Wharton.

METRO understands that this bid constitutes a firm offer to the District that cannot be withdrawn for 90 calendar days from the date of bid opening. More information on the bid is on Attachment A. Attachment includes Lobbying Certification, Buy America Provision, Bidder DBE Information, and Specification Data.

Due to the number of exemptions to the specifications taken by Taylor-Wharton, METRO is recommending that the bid be awarded to NexGen. METRO has correlated a Cost/Price Analysis on the NexGen bid to comply with federal requirements and has determined that the cost in the bid is justified.

Staff is recommending that the General Manager be authorized to execute a purchase for a Vertical LNG Storage Tank for the LCNG Fueling Station.

#### **IV. FINANCIAL CONSIDERATIONS**

The Vertical LNG Storage Tank for LCNG has a unit price of \$180,885.00. To transport the tank will result in a freight charge of \$6,500. The total cost for the Vertical LNG Storage Tank, shipping, and sales tax of 8.25% is \$202,308.01.

#### **V. ATTACHMENTS**

**Attachment A: IFB No. 04-04 Recap**

IFB No. 04-04 Recap

|             |  |          | Nexgen Fueling, A Division<br>of Chart Industries | Taylor-Wharton   |
|-------------|--|----------|---|--|
| Item<br>No. | Item Description   | Quantity | Unit Price  | Unit Price   |
| 1           | 15,000 Gallon, Vertical LNG<br>Storage Tank for an LCNG Vehicle<br>Fueling Station | One      | \$ 180,885.00                                     | \$ 178,625.00  |
| 2           | Sales Tax @ 8.25%  |          | \$ 14,923.01                                      | \$   |
| 3           | Freight Charges  |          | \$ 6,500.00                                       | \$ 19,240.00   |
| 4           | Total Bid Price  |          | \$ <b>202,308.01</b>                              | \$ 197,865.00  |
| 5           | Delivery   |          | 180 Calendar Days ARO<br>(6 months)               | 112 to 252 Calendar Days<br>ARO (3.7 to 8.4 months)          |
|             |  |          |   | California sales tax is not<br>collected <b>by</b> this firm |
|             |  |          |   | Exceptions listed  |

8.a1

Attachment **A**

COPY

PART I

BID FORM

The undersigned ("Bidder"), upon acceptance by the District, agrees to furnish all labor, freight, transportation, materials, equipment, services, supplies and other work in accordance with the Invitation for Bids entitled Item dated July 26, 2004 at the following prices. The unit bid prices should NOT INCLUDE SALES, USE, EXCISE OR ANY OTHER TAX, they are to be shown in the fifth column if applicable.

| Item No. | Item Description   | Quantity | Unit Price            |
|----------|--|----------|-----------------------|
| 1        | 15,000 Gallon, Vertical LNG Storage Tank for an LCNG Vehicle Fueling Station | One      | 180,885 <sup>00</sup> |
| 2        | Sales Tax @ 8.25%  |          | 14,923 <sup>01</sup>  |
| 3        | Freight Charges  |          | 6,500 <sup>00</sup>   |
| 4        | Total Bid Price  |          | 202,308 <sup>01</sup> |

Manufacturer/Model \_\_\_\_\_

Delivery of proposed storage tank will be 180 calendar days after receipt of order.

The successful bidder obligates him/herself to provide any or all of the bid items at the bid price. District reserves the right to award bid items separately or as a package. District may accept or reject the bid items at its discretion. Award of the bid will be based on totals provided for the Base Items, Options shall not be used in the determination of low bid. The Board of Directors also reserves the right to reject all bids for any reason.

Bidder has examined and is fully familiar with all terms and conditions of the Invitation for Bids and any addenda issued by the District thereto, and Bidder unconditionally submits this bid in strict accordance with said Invitation for Bids. Bidder has carefully checked all words and figures shown on this Bid Form and has carefully reviewed the accuracy of all documents, representations, manufacturer's literature, and statements submitted with this bid.

Bidder understands that this bid constitutes a firm offer to the District that cannot be withdrawn for ninety (90) calendar days from the date of bid opening. If awarded the contract, bidder agrees to deliver to the District executed copies of the final contract and required insurance certificates within ten (10) calendar days of the date of the District Notice of Award. Said Notice of Award shall be deemed duly given to Bidder upon delivery if delivered by hand, or three (3) calendar days after posting if sent by mail to Bidder's address.

Bidder understands that no partial, conditional or qualified bids shall be accepted for any bid item. Bidder further understands the right of the District Board of Directors to accept or reject any or all bids received for any reason. The District reserves the right to waive minor irregularities.

Bidder has included manufacturers' brochures describing the equipment bid under this IFB. Any proposed deviation from any item in the IFB specifications has been delineated on said brochures or on a separate attachment included with the bid. Bidder represents that the equipment and other work bid meets the specifications in all respects unless clearly noted to the contrary in the bid submittal.

The contract, if awarded, will be to the lowest responsive, responsible bidder. Bidder understands that the "lowest responsible bidder" is the lowest bidder whose offer best responds in quality, fitness and capacity to the requirements of the Invitation for Bids. The District reserves the right to award to other than the lowest bidder if the District finds that the lowest bidder is not responsible.

Bidder acknowledges receipt of the following addenda to the Invitation for Bids. All cost adjustments or other requirements resulting from said addenda have been taken into consideration by the bidder and included in the bid.

Addenda No.'s \_\_\_\_\_

Bidder has submitted the following documents with the bid:

1. Exceptions, if any, taken to the specifications or other sections of the IFB. (Warning: Substantive exceptions will be cause for bid rejection.)
2. Copy of any standard warranties in accordance with the Specifications.
3. Manufacturer's specifications, description, promotional material describing the item bid.
4. Fully executed copy of the "Lobbying Certification" listed as Page I-4 of the Bid, if applicable
5. Fully executed copy of the "Buy America Provision Certification" listed as Page I-5 of the Bid, if applicable.

Bidder understands that bids shall be placed in a sealed envelope marked as indicated below and delivered to the Purchasing Office of the Santa Cruz Metropolitan Transit District, 120 Dubois, Santa Cruz, California, 95060 prior to the time of bid opening. Bids postmarked before bid opening but delivered afterward shall be rejected.

IFB No. 04-04

"LNG Storage Tank"

Bid Opening 2:00 p.m., August 23, 2004

Bidder has full power and authority to enter into and perform the work described in the Invitation for Bids on behalf of the company noted below.

NEXGEN FUELING, A DIVISION OF CHART INDUSTRIES  
Company Name

Indicate:

Sole Proprietorship

Partnership

Corporation

Joint Venture with \_\_\_\_\_

3505 COUNTY ROAD 42 WEST  
Street Address

BURNSVILLE MN 55306-3803  
City, State, Zip Code

\_\_\_\_\_  
Signature of authorized company official

Claus Emmer, LNG Systems Sales Manager

\_\_\_\_\_  
Typewritten name of above and title

CLAUS EMMER, LNG SYSTEMS SALES MANAGER, claus.emmer@chart-ind.com  
Name, title, and email address of person to whom correspondence should be directed

(952) 882-5089  
Telephone Number

8(952)080  
FAX Number

7-30-04  
Date

41-1396485  
Federal Tax ID No.

The Santa Cruz Metropolitan Transit District is a special purpose District and is a subdivision of the State of California.

**LOBBYING CERTIFICATION**  
(Only for Contracts above \$100,000)

Lobbying Certification for Contracts Grants, Loans and Cooperative Agreements (Pursuant to 49 CFR Part 20, Appendix A)

The undersigned certifies, to the best of his or her knowledge and belief, that:

- (1) No Federal appropriated funds have been paid or will be paid, by or on behalf of the undersigned, to any person for influencing or attempting to influence an officer or employee of an agency, a Member of Congress, an officer or employee of Congress, or an employee of a Member of Congress in connection with the awarding of any Federal Contract, the making of any Federal grant, the making of any Federal loan, the entering into of any cooperative agreement, and the extension, continuation, renewal, amendment, or modification of any Federal Contract, grant, loan, or cooperative agreement.
- (2) If any funds other than Federal appropriated funds have been paid or will be paid to any person for making lobbying contacts to an officer or employee of any agency, a Member of Congress, an officer or employee of Congress, or an employee of a Member of Congress in connection with this Federal Contract, grant, loan, or cooperative agreement, the undersigned shall complete and submit Standard Form--LLL, "Disclosure Form to Report Lobbying," in accordance with its instructions and as amended by "Government wide Guidance for New Restrictions on Lobbying," 61 Fed. Reg. 14 13 (1/19/96).
- (3) The undersigned shall require that the language of this certification be included in the award documents for all sub awards at all tiers (including subcontracts, sub grants, and Contracts under grants, loans, and cooperative agreements) and that all sub recipients shall certify and disclose accordingly.

This certification is a material representation of fact upon which reliance was placed when this transaction was made or entered into. Submission of this certification is a prerequisite for making or entering into this transaction imposed by 31 U.S.C. § 1352 (as amended by the Lobbying Disclosure Act of 1995). Any person who fails to file the required certification shall be subject to a civil penalty of not less than \$10,000 and not more than \$100,000 for each such failure.

The Bidder/Offeror certifies or affirms the truthfulness and accuracy of each statement of its certification and disclosure, if any. In addition, the Bidder/Offeror understands and agrees that the provisions of 31 U.S.C. A 3801, et. seq. apply to this certification and disclosure, any.

Firm Name NEXGEN FUELING, A DIVISION OF CHART INDUSTRIES

Signature of Authorized Official 

Name and Title of Authorized Official CLAUS EMMER, LNG SYSTEMS SALES MANAGER

Date 7-30-04



**BUY AMERICA PROVISION**  
**(Only for Contracts above \$100,000)**

This procurement is subject to the Federal Transit Administration Buy America Requirements in 49 CFR part 661.

A Buy American Certificate, as per attached format, must be completed and submitted with the bid. A bid which does not include the certificate will be considered non-responsive.

A false certification is a criminal act in violation of 18 U.S.C. 1001. Should this procurement be investigated, the successful bidder/proposer has the burden of proof to establish that it is in compliance.

A waiver from the Buy America Provision may be sought by SCMTD if grounds for the waiver exist.

Section 165(a) of the Surface Transportation Act of 1982 permits FTA participation on this contract only if steel and manufactured products used in the contract are produced in the United States.

**BUY AMERICA CERTIFICATE**

The bidder hereby certifies that it will comply with the requirements of Section 165(a) or (b) (3) of the Surface Transportation Assistance Act of 1982, and the applicable regulations in 49 CFR Part 661.

Date: 7-30-04

Signature: \_\_\_\_\_

Company Name: NEKGEN FUELING, a CHART INDUSTRIES DIVISION

Title: CLAUS EMMER, LNG SYSTEMS SALES MANAGER

OR

The bidder hereby certifies that it cannot comply with the requirements of Section 165(a) or (b) (3) of the Surface Transportation Act of 1982, but may qualify for an exception to the requirement pursuant to Section 165(b)(2) or (b)(4) of the Surface Transportation Assistance Act of 1982, as amended, and regulations in 49 CFR 661.7.

Date: \_\_\_\_\_

Signature: \_\_\_\_\_

Company Name: \_\_\_\_\_

Title: \_\_\_\_\_

# BIDDER DBE INFORMATION

BIDDER'S NAME \_\_\_\_\_  
 DBE GOAL FROM CONTRACT \_\_\_\_\_ %  
 FED. NO. \_\_\_\_\_  
 COUNTY \_\_\_\_\_  
 AGENCY \_\_\_\_\_  
 CONTRACT NO. \_\_\_\_\_

BIDDER'S ADDRESS \_\_\_\_\_  
 \_\_\_\_\_  
 BID AMOUNT \$ \_\_\_\_\_  
 BID OPENING DATE \_\_\_\_\_  
 DATE OF DBE CERTIFICATON \_\_\_\_\_  
 SOURCE \*\* \_\_\_\_\_

This information must be submitted during the initial negotiations with the District. By submitting a proposal, offeror certifies that he/she is in compliance with the District's policy. Failure to submit the required DBE information by the time specified will be grounds for finding the bid or proposal non-responsive.

| CONTRACT<br>ITEM NO. | ITEM OF WORK AND DESCRIPTION OF<br>WORK OR SERVICES TO BE SUBCONTRACTED<br>OR MATERIALS TO BE PROVIDED * | CERTIFICATION<br>FILE NUMBER | NAME OF DBE | DOLLAR<br>AMOUNT<br>DBE *** | PERCENT<br>DBE |
|----------------------|--|------------------------------|-------------|-----------------------------|----------------|
|----------------------|--|------------------------------|-------------|-----------------------------|----------------|

*NONE*

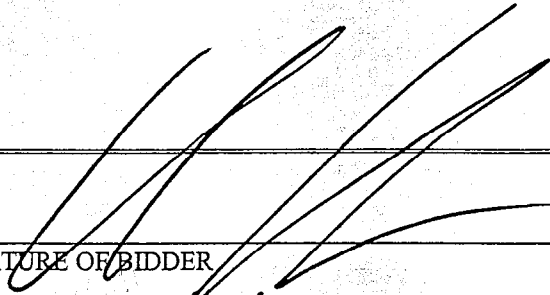
  
 SIGNATURE OF BIDDER \_\_\_\_\_  
 AREA CODE/TELEPHONE (952) 882-5089

TOTAL CLAIMED DBE  
 PARTICIPATION \$ \_\_\_\_\_ %

DATE 7-30-04

(Detach from proposal if DBE information is not submitted with bid.)

\* If 100% of item is not to be performed or furnished by DBE, describe exact portion, including plan location of work to be performed, of item to be performed or furnished by DBE.  
 \*\* DBE's must be certified on the date bids are opened  
 \*\*\* Credit for a DBE supplier who is not a manufacturer is limited to 60% of the amount paid to the supplier.

**NOTE:** Disadvantaged business must renew their certification annually by submitting certification questionnaires in advance of expiration of current certification. Those not on a current list cannot be considered as certified.

*8.06*

# BIDDER DBE INFORMATION

| CONTRACT<br>ITEM NO. | ITEM OF WORK AND DESCRIPTION OF<br>WORK OR SERVICES TO BE SUBCONTRACTED<br>OR MATERIALS TO BE PROVIDED * | CERTIFICATION<br>FILE NUMBER | NAME OF DBE | DOLLAR<br>AMOUNT<br>DBE *** | PERCENT<br>DBE |
|----------------------|--|------------------------------|-------------|-----------------------------|----------------|
|----------------------|--|------------------------------|-------------|-----------------------------|----------------|

TOTAL CLAIMED DBE PARTICIPATION \$ \_\_\_\_\_ %

8.27

| INNER VESSEL DESIGN DATA   |                                   |                    |       |       |
|--|-----------------------------------|--------------------|-------|-------|
| Model:   | VS-9000 THRU 15000                |                    |       |       |
| MAWP:  | PSIG                              | 175                | 250   | 400   |
|  | bar(g)                            | 12.07              | 17.24 | 27.58 |
| DESIGN PRESSURE  | PSIG                              | 189.7              | 264.7 | 414.7 |
|  | bar(g)                            | 13.08              | 18.25 | 28.59 |
| CODE COMPLIANCE:   | ASME SECTION VIII DIVISION I      |                    |       |       |
| DESIGN TEMPERATURE   | °F                                | -320° TO 100°      |       |       |
|  | °C                                | -195.56° TO 37.78° |       |       |
| MATERIAL OF CONSTRUCTION:  | SA553 9% NICKEL STEEL             |                    |       |       |
| OUTER VESSEL DATA  |                                   |                    |       |       |
| CODE COMPLIANCE:   | FULL VACUUM PER CGA-341           |                    |       |       |
| DESIGN TEMPERATURE   | °F                                | -20° TO 300°       |       |       |
|  | °C                                | -28.89 TO 148.9    |       |       |
| MATERIAL OF CONSTRUCTION:  | A36 CARBON STEEL                  |                    |       |       |
| INSULATION TYPE  | /VACUUM AND MULTILAYER INSULATION |                    |       |       |
| EVACUATION CONNECTION:   | 3-1/2" PUMPOUT P O R T            |                    |       |       |
| VACUUM GAUGE CONNECTION:   | HASTING DVR6                      |                    |       |       |
| <b>BUILDING CODE:</b>  |                                   |                    |       |       |
| DESIGNED FOR CURRENT BUILDING CODE SEE MVE<br>UBC POLICY #NP-180 |                                   |                    |       |       |

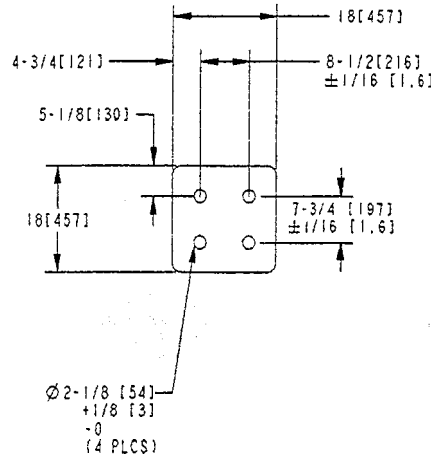

**FOOT PAR**  
 1-3181351 THK 9000/11000/13000  
 1-3/4(44) THK 15000  
 TYP (3) PLCS

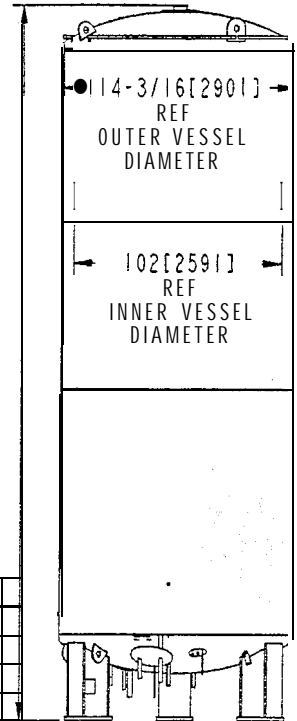

SCALE 7/320

**WEIGHTS AND SHIPPING DATA**

| MWP                 | MODEL:             | vs-9000               |         |         | VS-11000               |         |         | VS-13000               |         |         | VS-15000               |         |         |         |
|---------------------|--------------------|-----------------------|---------|---------|------------------------|---------|---------|------------------------|---------|---------|------------------------|---------|---------|---------|
|                     |                    | PSIG                  | 175     | 250     | 400                    | 175     | 250     | 400                    | 175     | 250     | 400                    | 175     | 250     | 400     |
| WEIGHT EMPTY        | POUNDS             | 33.000                | 36.800  | 44.800  | 39.500                 | 44.100  | 53.700  | 46.700                 | 52.100  | 62.700  | 53.700                 | 59.900  | 72.200  |         |
|                     | KILOGRAMS          | 14.970                | 16.700  | 20.330  | 17.920                 | 20.010  | 24.360  | 21.190                 | 23.640  | 28.450  | 24.360                 | 27.180  | 32.660  |         |
| WEIGHT FULL         | OXYGEN             | POUNDS                | 119.600 | 123.400 | 131.400                | 145.900 | 159.900 | 111.700                | 177.100 | 187.700 | 197.500                | 203.700 | 215.800 |         |
|                     |                    | KILOGRAMS             | 54.250  | 55.980  | 59.610                 | 66.090  | 72.530  | 77.890                 | 80.340  | 85.148  | 89.590                 | 92.400  | 97.890  |         |
|                     | NITROGEN           | POUNDS                | 94.300  | 98.100  | 105.100                | 114.700 | 119.300 | 128.900                | 135.200 | 140.600 | 151.200                | 155.600 | 161.800 | 173.900 |
|                     |                    | KILOGRAMS             | 42.780  | 44.500  | 48.130                 | 52.030  | 54.120  | 58.470                 | 61.330  | 63.780  | 68.590                 | 70.580  | 73.400  | 78.880  |
|                     | ARGON              | POUNDS                | 138.700 | 142.500 | 150.500                | 169.200 | 173.800 | 183.400                | 199.300 | 204.700 | 215.300                | 229.300 | 235.500 | 247.600 |
|                     |                    | KILOGRAMS             | 62.690  | 64.640  | 68.270                 | 76.750  | 78.840  | 83.190                 | 90.410  | 92.860  | 97.660                 | 104.010 | 106.830 | 112.310 |
| SHIPPING DIMENSIONS | INCHES (L * W * H) | 347 x 114.2 x 114.2   |         |         | 406 x 114.2 x 114.2    |         |         | 465 x 114.2 x 114.2    |         |         | 525 x 114.2 x 114.2    |         |         |         |
|                     | MM (L * W * H)     | 8,814 x 2,901 x 2,901 |         |         | 10,312 x 2,901 x 2,901 |         |         | 11,811 x 2,901 x 2,901 |         |         | 13,335 x 2,901 x 2,901 |         |         |         |

| TANK HEIGHT |             |  |
|-------------|-------------|--|
| MODEL       | DIM "A" REF |  |
| VS-9000     | 347(8.814)  |  |
| VS-11000    | 406(10.312) |  |
| VS-13000    | 465(11.811) |  |
| VS-15000    | 525(13.335) |  |

**CAPACITIES**

| CAPACITY         | MODEL: | VS-9000       |             |           |           | VS-11000  | VS-13000 | VS-15000 |
|------------------|--------|---------------|-------------|-----------|-----------|-----------|----------|----------|
|                  |        | GROSS GALLONS | NET GALLONS | LITERS    | LITERS    |           |          |          |
| GASES EQUIVALENT | OXYGEN | SCF           | 1,442,000   | 1,282,000 | 1,509,000 | 1,737,000 |          |          |
|                  |        | NM3           | 27,400      | 33,700    | 39,600    | 45,600    |          |          |
|                  |        | F/NITROGEN    | 845.000     | 1,037.000 | 1,221.000 | 1,405.000 |          |          |
| GASES EQUIVALENT | ARGON  | SCF           | 1,202,000   | 1,253,000 | 1,475,000 | 1,697,000 |          |          |
|                  |        | NM3           | 8,000       | 32,900    | 38,700    | 44,600    |          |          |
|                  |        | F/NITROGEN    | 22.200      | 27.200    | 32.100    | 36.900    |          |          |

| REV | ECR NO | REVISION DESCRIPTION  | BY  | DATE    | APPROVED | DATE     |
|-----|--------|-----------------------|-----|---------|----------|----------|
| C   | 12022  | CHG BLT HL DIM SCHEME | RDW | 12/9/02 | JEN      | 12-7-00  |
| B   | -      | UPDATE DRWG TOL       | MMK | 2-8--01 | DCH      | 12-11-00 |
| A   | 11553  | CHG LEG PAD           | MMK | 1-01-01 | KJR      | 12-12-00 |
| REV | ECR NO | REVISION DESCRIPTION  | BY  | DATE    | APPROVED | DATE     |
|     |        |                       |     |         | GAP      | 12-11-00 |
|     |        |                       |     |         | FAS      | 12-14-00 |
|     |        |                       |     |         | LBL      | 12-12-00 |

THE MATERIALS AND INFORMATION, INCLUDING THE PRINCIPLES OF DESIGN CONTAINED IN THIS PRINT, IS THE EXCLUSIVE PROPERTY OF CHART INC. AND IS CONFIDENTIAL AND PROPRIETARY INFORMATION. THIS INFORMATION MAY NOT BE REPRODUCED, COPIED, OR LOANED, IN PART OR IN WHOLE, NOR IS THE INFORMATION TO BE RELATED TO ANY PARTY WITHOUT CHART'S PRIOR WRITTEN CONSENT.

PART NUMBER  
**11502954**

DRAWING NO. **C-11502954** REV **C**

SCALE N/A DO NOT SCALE DRAWING SHEET 1 OF 2

802

1 ATM AND 70°F  
1 ATM AND 0°C

COPY

**PART I**

**RID FORM**

The undersigned ("Bidder"), upon acceptance by the District, agrees to furnish all labor, freight, transportation, materials, equipment, services, supplies and other work in accordance with the Invitation for Bids entitled Item dated July 26, 2004 at the following prices. The unit bid prices should NOT INCLUDE SALES, USE, EXCISE OR ANY OTHER TAX. they are to be shown in the fifth column if applicable.

| Item No. | Item Description   | Quantity | Unit Price                                   |
|----------|--|----------|--|
| 1        | 15,000 Gallon, Vertical LNG Storage Tank for an LCNG Vehicle Fueling Station | One      | \$178,625.00                                 |
| 2        | Sales Tax @ 8.25%  |          | Not Collected, See Section 8 of Cover Letter |
| 3        | Freight Charges  |          | \$19,240.00                                  |
| 4        | <b>Total Bid Price</b>   |          | <b>\$197,865.00</b>                          |

Manufacturer/Model] Taylor-Wharton VT-15,000-LNG

Delivery of proposed storage tank will be 112 to 252 calendar days after receipt of order.

The successful bidder obligates him/herself to provide any or all of the bid items at the bid price. District reserves the right to award bid items separately or as a package. District may accept or reject the bid items at its discretion. Award of the bid will be based on totals provided for the Base Items, Options shall not be used in the determination of low bid. The Board of Directors also reserves the right to reject all bids for any reason.

Bidder has examined and is fully familiar with all terms and conditions of the Invitation for Bids and any addenda issued by the District thereto, and Bidder unconditionally submits this bid in strict accordance with said Invitation for Bids. Bidder has carefully checked all words and figures shown on this Bid Form and has carefully reviewed the accuracy of all documents, representations, manufacturer's literature, and statements submitted with this bid.

Bidder understands that this bid constitutes a firm offer to the District that cannot be withdrawn for ninety (90) calendar days from the date of bid opening. If awarded the contract, bidder agrees to deliver to the District executed copies of the final contract and required insurance certificates within ten (10) calendar days of the date of the District Notice of Award. Said Notice of Award shall be deemed duly given to Bidder upon delivery if delivered by hand, or three (3) calendar days after posting if sent by mail to Bidder's address.

Bidder understands that no partial, conditional or qualified bids shall be accepted for any bid item. Bidder further understands the right of the District Board of Directors to accept or reject any or all bids received for any reason. The District reserves the right to waive minor irregularities.

Bidder has included manufacturers' brochures describing the equipment bid under this IFB. Any proposed deviation from any item in the IFB specifications has been delineated on said brochures or on a separate attachment included with the bid. Bidder represents that the equipment and other work bid meets the specifications in all respects unless clearly noted to the contrary in the bid submittal.

The contract, if awarded, will be to the lowest responsive, responsible bidder. Bidder understands that the "lowest responsible bidder" is the lowest bidder whose offer best responds in quality, fitness and capacity to the requirements of the Invitation for Bids. The District reserves the right to award to other than the lowest bidder if the District finds that the lowest bidder is not responsible.

8.29

Bidder acknowledges receipt of the following addenda to the Invitation for Bids. All cost adjustments or other requirements resulting from said addenda have been taken into consideration by the bidder and included in the bid.

Addenda No.'s No Addenda Received

Bidder has submitted the following documents with the bid:

1. Exceptions, if any, taken to the specifications or other sections of the IFB. (Warning: Substantive exceptions will be cause for bid rejection.)
2. Copy of any standard warranties in accordance with the Specifications.
3. Manufacturer's specifications, description. promotional material describing the item bid.
4. Fully executed copy of the "Lobbying Certification" listed as Page 1-4 of the Bid, if applicable
5. Fully executed copy of the "Buy America Provision Certification" listed as Page 1-5 of the Bid, if applicable.

Bidder understands that bids shall be placed in a sealed envelope marked as indicated below and delivered to the Purchasing Office of the Santa Cruz Metropolitan Transit District, 120 Dubois, Santa Cruz, California, 95060 prior to the time of bid opening. Bids postmarked before bid opening but delivered afterward shall be rejected.

**IFB No. 04-04**  
**"LNG Storage Tank"**  
**Bid Opening 2:00 p.m., August 23, 2004**

Bidder has full power and authority to enter into and perform the work described in the Invitation for Bids on behalf of the company noted below.

Taylor-Wharton

Company Name

Indicate:

CI Sole Proprietorship  Partnership  Corporation

Joint Venture with \_\_\_\_\_

4075 Hamilton Blvd.

Street Address

Theodore, AL 36582

City, State, Zip Code

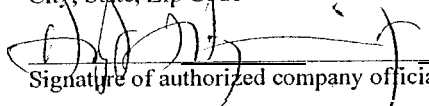

Signature of authorized company official

Hoyt Fitzsimmons, Vice President / General Manager Cryogenics

Typewritten name of above and title

Justin Gish, LNG Product Manager, jgish@harsco.com

Name, title, and email address of person to whom correspondence should be directed

800-898-2657

Telephone Number

251-443-2250

FAX Number

August 19th, 2004

Date

23-1483991

Federal Tax ID No.

The Santa Cruz Metropolitan Transit District is a special purpose District and is a subdivision of the State of California.

8.910

**LOBBYING CERTIFICATION**  
(Only for Contracts above \$100,000)

**Lobbying Certification for Contracts Grants, Loans and Cooperative Agreements (Pursuant to 49 CFR Part 20, Appendix A)**

The undersigned certifies, to the best of his or her knowledge and belief, that:

- (1) No Federal appropriated funds have been paid or will be paid, by or on behalf of the undersigned, to any person for influencing or attempting to influence an officer or employee of an agency, a Member of Congress, an officer or employee of Congress, or an employee of a Member of Congress in connection with the awarding of any Federal Contract, the making of any Federal grant, the making of any Federal loan, the entering into of any cooperative agreement, and the extension, continuation, renewal, amendment, or modification of any Federal Contract, grant, loan, or cooperative agreement.
- (2) If any funds other than Federal appropriated funds have been paid or will be paid to any person for making lobbying contacts to an officer or employee of any agency, a Member of Congress, an officer or employee of Congress, or an employee of a Member of Congress in connection with this Federal Contract, grant, loan, or cooperative agreement, the undersigned shall complete and submit Standard Form--LLL, "Disclosure Form to Report Lobbying," in accordance with its instructions and as amended by "Government wide Guidance for New Restrictions on Lobbying," 61 Fed. Reg. 1413 (1/19/96).
- (3) The undersigned shall require that the language of this certification be included in the award documents for all sub awards at all tiers (including subcontracts, sub grants, and Contracts under grants, loans, and cooperative agreements) and that all sub recipients shall certify and disclose accordingly.

This certification is a material representation of fact upon which reliance was placed when this transaction was made or entered into. Submission of this certification is a prerequisite for making or entering into this transaction imposed by 31 U.S.C. § 1352 (as amended by the Lobbying Disclosure Act of 1995). Any person who fails to file the required certification shall be subject to a civil penalty of not less than \$10,000 and not more than \$100,000 for each such failure.

The Bidder/Offeror certifies or affirms the truthfulness and accuracy of each statement of its certification and disclosure, if any. In addition, the Bidder/Offeror understands and agrees that the provisions of 31 U.S.C. A 3801, et. seq. apply to this certification and disclosure, if any.

Firm Name Taylor-Wharton

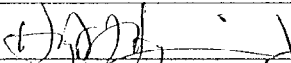
Signature of Authorized Official 

Name and Title of Authorized Official Hoyt Fitzsimmons, Vice President / General Manager Cryogenics

Date August 19th, 2004

**BUY AMERICA PROVISION  
(Only for Contracts above \$100,000)**

This procurement is subject to the Federal Transit Administration Buy America Requirements in 49 CFR part 661.

A Buy American Certificate, as per attached format, must be completed and submitted with the bid. A bid which does not include the certificate will be considered non-responsive.

A false certification is a criminal act in violation of 18 U.S.C. 1001. Should this procurement be investigated, the successful bidder/proposer has the burden of proof to establish that it is in compliance.

A waiver from the Buy America Provision may be sought by SCMTD if grounds for the waiver exist.

Section 165(a) of the Surface Transportation Act of 1982 permits FTA participation on this contract only if steel and manufactured products used in the contract are produced in the United States.

**BUY AMERICA CERTIFICATE**

The bidder hereby certifies that it will comply with the requirements of Section 165(a) or (b) (3) of the Surface Transportation Assistance Act of 1982, and the applicable regulations in 49 CFR Part 66 1.

Date: August 19th, 2004  
Signature:   
Company Name: Taylor-Wharton  
Title: Hoyt Fitzsimmons, Vice President / General Manager Cryogenics

OR

The bidder hereby certifies that it cannot comply with the requirements of Section 165(a) or (b) (3) of the Surface Transportation Act of 1982, but may qualify for an exception to the requirement pursuant to Section 165(b)(2) or (b)(4) of the Surface Transportation Assistance Act of 1982, as amended, and regulations in 49 CFR 661.7.

Date: \_\_\_\_\_  
Signature: \_\_\_\_\_  
Company Name: \_\_\_\_\_  
Title: \_\_\_\_\_

8.a12



Taylor-Wharton

Harsco



4075 Hamilton Boulevard  
Theodore, AL 36582 USA  
Factory Telephone: 251-443-8680  
Factory Fax: 251-443-2250  
www.taylorwharton.com

August 19, 2004

Santa Cruz Metropolitan Transit District  
Purchasing Office  
120 Dubois Street  
Santa Cruz, California 95060

Re: Santa Cruz Metropolitan Transit District IFB No. 04-04, 15,000 Gallon Vertical  
LNG Storage Tank

Dear Sir or Madam:

Taylor-Wharton is pleased to offer the following for your consideration.

**A. Exceptions to Invitation for Bid**

The following additional exceptions to the invitation for bid, IFB NO. 04-04, apply:

- 1.03 B. Analysis and design of the concrete tank foundation will not be performed by Taylor-Wharton.
- 1.05. The warranty is per Taylor-Wharton's Terms of Sale or Acknowledgement, revised February 2004 and attached hereto.
- 2.01.B.13. The LNG tank leg support insulation required for the 2 hour fire resistances rating is not included. The insulation may be damaged during shipment and tank installation. Taylor-Wharton recommends that this insulation be applied after the tank is placed on its permanent foundation.

We must take exception to the following parts of the invitation for bid, IFB NO. 04-04, until our legal department has had the opportunity to review them completely:

- Part IV General Condition to the Contract
- Part V Special Conditions of the Contract
- Part VI Contract for Procurement of LNG Storage Tank
- Part VII Federal Transit Administration Requirements for Non-Constructive Contracts

**B. Pricing**

The price listed on part I-1 of the bid form includes a material surcharge of \$1,947.00. California State sales tax will not be collected by Taylor-Wharton provided that the proper exemption or self-paying certificate is provided.

### **C. Delivery Schedule**

The tank will be completed 16 to 36 weeks (112 to 252 calendar days) after receipt of order. Actual completion date will be determined upon selection of contractor. The current production schedule and material inventory is such that an order placed at the time of this writing would be completed in 16 weeks.

### **D. Design**

The tank is a vertical liquid natural gas storage tank with a gross warm volume of 14,999 gallons. Net cold liquid capacity is 13,420 gallons. Maximum allowable working pressure is 250 psig. The inner vessel is of 9% nickel steel construction in accordance with ASME Section VIII, Division I. The design temperature of the inner vessel is -320°F to +100° F. The inner vessel is vacuum and perlite insulated within a carbon steel outer jacket. Annular space (space between the inner vessel and outer jacket) piping is welded type 304 stainless steel.

### **E. Tank Data**

A general arrangement drawing showing tank dimensions, weight, line sizes, leg dimensions, and other information is included with this submittal.

### **F. External Piping Description**

External piping and controls are stainless steel except for relief valves. Relief valves may be stainless steel or brass. The primary relief valves are set to discharge at 175 psig. All relief valves, vent valves, rupture discs, and the trycock valve are piped to a common header and vented through a common vent stack. Refer to the attached general arrangement drawing for the piping and instrument diagram.

Pneumatically operated and vacuum jacketed valves are included on the tank pipes designated A through E. These valves are CPC-Cryolab, Model CV8, globe pattern with air actuator or equivalent. The valves are configured for air to open and air loss to close. A total of five of these pneumatically operated and vacuum jacketed valves are included in the following pipe sizes:

| Size   | Quantity |
|--------|----------|
| 1"     | 1        |
| 1-1/2" | 2        |
| 2"     | 1        |
| 3"     | 1        |

### **G. Design Codes**

The design codes, standards, and regulatory requirements listed in sections 1.02.A and 1.04.A of the invitation for bid, IFB NO. 04-04, will be adhered to where applicable.

**H. Items not provided by Taylor-Wharton**

1. Lifting slings for loading and unloading tank.
2. Foundation designs.

**I. Miscellaneous**

Offer is subject to Taylor-Wharton's current Terms of Sale or Acknowledgement, attached.

Price is FOB factory, Theodore, Alabama.

Price is valid for 30 days.

Thank you for allowing Taylor-Wharton to provide a proposal for your equipment requirements. If you have any questions or if I may be of further service, please call me at 251-443-2287.

Sincerely,

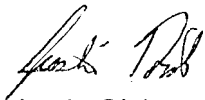

Justin Gish  
LNG Product Manager  
Taylor-Wharton

cc: H. Fitzsimmons  
D. Loper

Attachments:

Bib Form, Part 1 of Santa Cruz Metropolitan Transit District IFB No. 04-04  
Terms of Sale or Acknowledgement, Revised February 2004  
General Arrangement Drawing 2214835

**TERMS OF SALE OR ACKNOWLEDGEMENT**  
**Revised February 2004**  
**Supersedes All Previous Terms And Conditions Of Sale**

**ACCEPTANCE OF TERMS AND CONDITIONS**

The acceptance of the Terms and Conditions contained herein is an essential prerequisite to any contract of sale made by Seller. Any offer or acceptance by Seller is made subject to the terms and conditions contained herein and no additional or different terms offered by Buyer shall become a part of the Agreement of Sale between Seller and Buyer unless such terms have been expressly approved in writing by an authorized agent of Seller. If this document is an offer, acceptance of this offer is expressly limited to the terms hereof and Seller reserves the right to withdraw this offer at any time before its acceptance by Buyer. If this document has been issued by Seller in response to a written offer made by Buyer, Seller's acceptance of Buyer's offer is expressly conditioned on Buyer's assent to the additional or different terms contained herein. If these terms and conditions are not acceptable, Buyer shall notify Seller in writing at once. Buyer's action in (a) accepting any goods manufactured and delivered hereunder, or (b) receiving this document without disaffirmance within three (3) business days of receipt shall constitute an unqualified acceptance by Buyer of the Terms and Conditions contained herein.

**PAYMENT TERMS**

All prices do not include local, state or federal taxes. Taxes are for the account of the Buyer. Payment of shipping costs will be in accordance with the provisions on the face hereof. Payment terms appear on the face of our invoice. All orders are subject to credit approval.

**DELIVERY**

All delivery terms and dates are subject to the availability of the necessary shop space, transportation and production hours. Unless otherwise specified on the face of this invoice, title and risk of loss pass from Seller to Buyer at the point of shipment. Buyer is responsible for timely inspecting product on receipt and initiating and pursuing all claims for freight damage.

**CANCELLATION AND RETURNS**

Buyer agrees that, without Seller's prior written approval, an order or portion thereof may not be cancelled by Buyer and no product purchased from Seller hereunder may be returned by Buyer for credit. If cancellation of an order or portion thereof is approved by Seller, a cancellation fee equal to a minimum of 15% of the value of the cancelled order will be paid by Buyer. If cancellation occurs after material has been purchased or fabrication has been started, the cancellation fee shall be an amount sufficient to compensate Seller for the materials acquired and the work performed prior to cancellation, with the materials to remain the property of Seller. If a product return is approved by the Seller, a re-stocking fee equal to a minimum of 15% of the value of the returned product will be paid by Buyer. Cancellation of an order or portion thereof by the Buyer without the approval and agreement of the Seller will subject Buyer to special, direct, indirect and consequential damages.

**LIQUIDATED DAMAGES**

Buyer agrees that if any invoice or part thereof is not paid and Seller is required to institute legal proceedings for collection of any invoice or part thereof that Seller may impose as Liquidated Damages a charge of one (1%) percent per month or the maximum applicable legal amount upon any overdue amount to offset Seller's anticipated damages, including collection and accounting costs.

**JURISDICTION AND VENUE**

The validity, performance and interpretation of this Agreement shall be governed by the laws of the State of Alabama and of the United States except for any such law which incorporates the United Nations Convention on Contracts for the International Sale of Goods or any other International Law. The parties agree that any controversy arising under this Agreement shall be determined by the federal or state courts situated in the State of Alabama, and both parties hereby submit and consent to the jurisdiction and venue of said courts.

**CLAIMS**

The Seller will not be responsible for handling, storage, demurrage or any other transportation or accessorial service on orders for shipment outside the United States.

**TOLERANCES & VARIATIONS**

Unless otherwise specified by Seller in writing on front of these Terms of Sale, all goods will be subject to tolerances and variations consistent with usual trade practices regarding dimensions, straightness, section, composition and mechanical properties and normal variations in surface and internal conditions and quality and will also be subject to deviations from tolerances and variations consistent with practical testing and inspection methods.

**FILINGS**

Buyer upon request of the Seller will execute any documents necessary, including UCC statements to evidence Buyer's indebtedness to Seller.

**COMPLIANCE**

Seller states its intention to comply with all Federal laws applicable to Seller's performance. If the product sold hereunder consists of or includes liquid cylinders intended for medical service, Buyer acknowledges its responsibility to have tamper proof end fittings installed per Compressed Gas Association Safety Bulletin 26 (CGA SB-26).

**DELAY**

Seller will not be responsible for any delay in performance due to acts of God, war, riots, embargoes, acts of civil or military authorities, fires, floods, accidents, quarantine restrictions, mill conditions, strikes, differences with workmen, delays in transportation, shortage of cars, fuel, labor or materials, or any cause beyond the reasonable control of the Seller.

**LIMITED WARRANTY**

**Bulk Cryogenic Storage Tanks:**

Seller warrants to the initial user of each cryogenic storage tank, control manifold and vaporizer that such equipment will be free from defects in materials and workmanship and will perform in accordance with seller's standard specifications under normal use during period of eighteen (18) months from delivery or twelve (12) months from date of initial operation of the equipment (whichever is first) if used, operated and maintained according to Seller's written instructions. Seller's warranty as to components manufactured by third parties and used in any equipment described herein will be limited to extending to the initial user such warranty as may be offered by such original manufacturer.

**Refrigerators and Dewars, easyCARB™ (formerly LIQUIDATOR™) and XL Series Cryogenic Liquid Cylinders:**

Seller warrants that each of its refrigerators and dewars, easyCARB™ liquid cylinders manufactured for carbon dioxide service, and the internal structural support system of each XL Series liquid cylinder, will be free from defects in material and workmanship, in the normal service for which the product was manufactured, for a period of ninety (90) days date of shipment to the original purchaser. The product is further warranted to maintain a Normal Evaporation Rate (NER) within 10% of Seller's published specifications for the product, on the date of shipment. This warranty is in effect for all XT, HC LS, CX, and LI Series refrigerator and dewar products for a period of three (3) years from the date of shipment to the original purchaser, for all K Series refrigerators for a period of two (2) years from date of shipment to the original purchaser, and for all easyCARB™ liquid cylinders XL Series liquid cylinders for a period of five (5) years from the date of shipment to the original purchaser, if the product is maintained according to Seller's published instructions.

**LNG Vehicular Fuel Tanks:**

Seller warrants to the initial user of each LNG Vehicular Fuel Tank that such equipment will be free from defects in material and workmanship, in the normal service for which the product was manufactured, for a period of one year from the date of shipment to original purchaser. The product is further warranted to maintain all vacuum and performance standards for said equipment, as published by T-W on the date of shipment, for a period of forty-two (42) months from delivery or thirty-six (36) months from the date of initial operation of the equipment (whichever is first) if used, operated and maintained according to Seller's written instructions. Seller's warranty as to components manufactured by third parties and used in any equipment described herein will be limited to extending to the initial user such warranty as may be offered by such original manufacturer. Plumbing leaks are warrantable a period of ninety (90) days from the date of initial operation of the equipment.

THE REMEDIES SET FORTH HEREIN ARE EXCLUSIVE. SELLER SHALL NOT BE LIABLE FOR ANY CONSEQUENTIAL, SPECIAL, OR INCIDENTAL DAMAGES RESULTING FROM THE DELIVERY, USE OR FAILURE OF THE PRODUCT (INCLUDING LOSS OF ANY MATERIALS STORED IN PRODUCT), OR FROM ANY OTHER CAUSE WHATSOEVER BY ACCEPTING DELIVERY OF THE PRODUCT SOLD HEREUNDER. THE BUYER ACCEPTS THIS LIMITATION OF REMEDIES AS REASONABLE AND ENFORCEABLE. IN NO EVENT SHALL SELLER'S LIABILITY EXCEED THE PURCHASE PRICE FOR THE PRODUCT.

To make a claim under these warranties, the Buyer must 1) give Seller written notice within ten (10) days after discovery of a claimed defect. 2) Immediately discontinue use of the product; and (for Refrigerators, Dewars, easyCARB™ and XL Series Liquid Cylinders) : return such product freight prepaid to the location specified by Seller for evaluation to validate the warranty claim.

This warranty is voided by alterations or repairs of others. Seller shall not be liable under warranty, or otherwise, for defects caused by negligence, abuse or misuse of this product, corrosion, fire, heat, or the effects of normal wear. Any related components or other equipment manufactured by others, which may be sold with Seller's product, are not covered by this warranty.

Seller's sole liability under these warranties shall be limited to the repair, or at its option, replacement or refund of the purchase price, of such equipment which proves to be defective.

THE ABOVE EXPRESS WARRANTY IS IN LIEU OF ANY WARRANTY OF MERCHANTABILITY AND ALL OTHER EXPRESS OR IMPLIED WARRANTIES WITH RESPECT TO THIS PRODUCT.

This warranty gives Buyer specific legal rights, and you may also have other rights, which vary from state to state.



**Taylor-Wharton**  
Harsco



**Gas & Fluid Control Group**  
Harsco

Taylor-Wharton Cryogenics  
4075 Hamilton Blvd  
Theodore, AL 36582 USA  
Phone 800-898-2657  
Phone 251-443-8680  
Fax 251-443-2250

8.916

- NOTES:
- EXTERNAL PIPING AND VALVES (EXCEPT TANK SAFETY VALVES) TO BE STAINLESS STEEL.
  - SEISMIC DESIGN PER UBC 1997 ZONE 4. MEETS NFPA 59A, CHARACTER 0.
  - TORR SEAL TO BE USED ON TC AND V-5 (VACUUM GAUGE).
  - SAFETY VALVES ARE TO BE SET AT 175 PSIG.
  - EXTERNAL PIPING, VALVES, AND INSTRUMENTS ARE NOT SHOWN. PIPING DESIGN IS TO BE COMPLETED TO CUSTOMER'S SPECIFICATIONS AFTER AWARD OF CONTRACT.

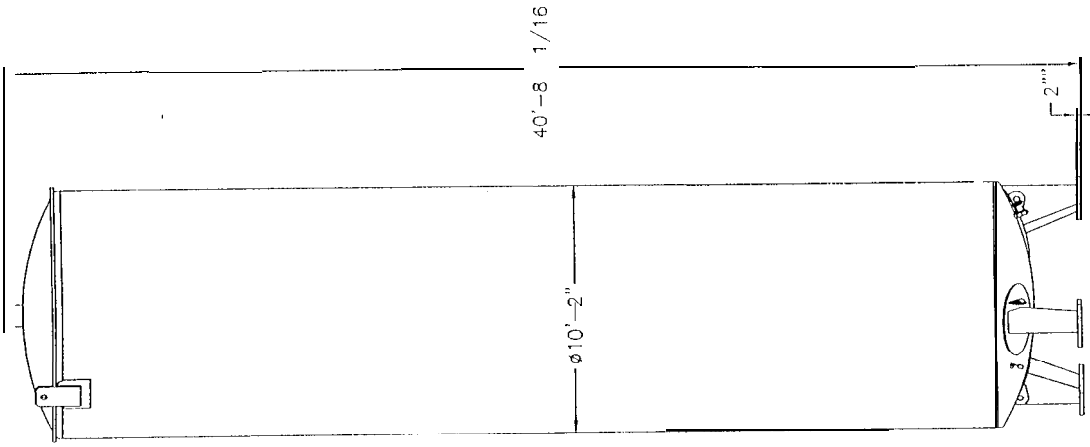
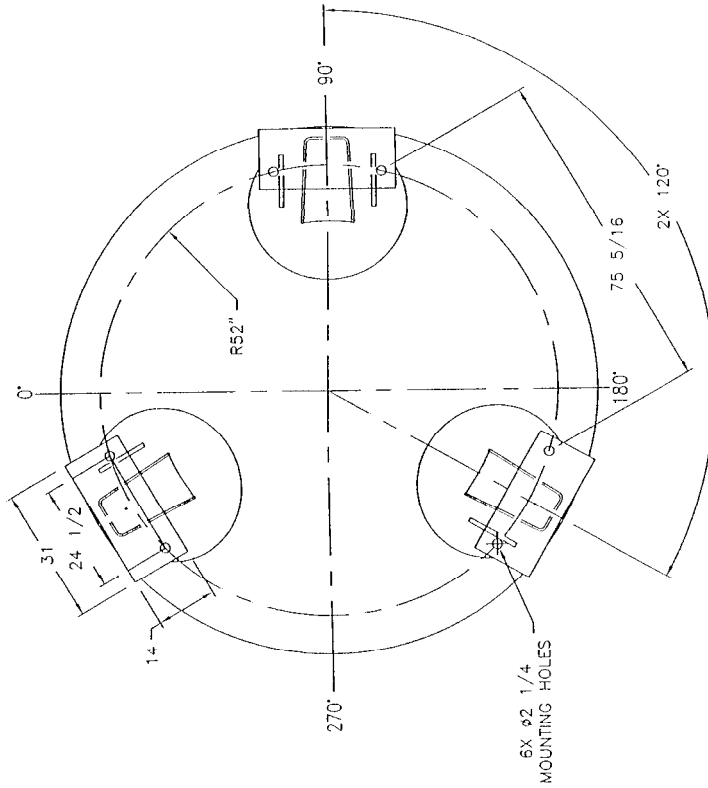

THIS IS A 2-D DIMENSIONED DRAWING. SHEET 1 OF 1.

|  |             |            |          |
|--|-------------|------------|----------|
| PROJECT NO.                            | REVISED BY  | DATE       | SCALE    |
| GENERAL ARRANGEMENT                    | JCC         | 8/19/04    | AS SHOWN |
| VT-15000-LNG, SANTA CRUZ MID METROBASE | DESIGNED BY | CHECKED BY | DATE     |
|  | PROJECT NO. | SCALE      | DATE     |
|  | D           | 2214835    |          |

UNLESS OTHERWISE SPECIFIED:  
 UNITS: INCHES  
 DECIMALS: 1/16  
 FRACTIONS: 1/16  
 UNLESS OTHERWISE SPECIFIED:  
 UNITS: METERS  
 DECIMALS: 0.001  
 FRACTIONS: 1/1000

8.917

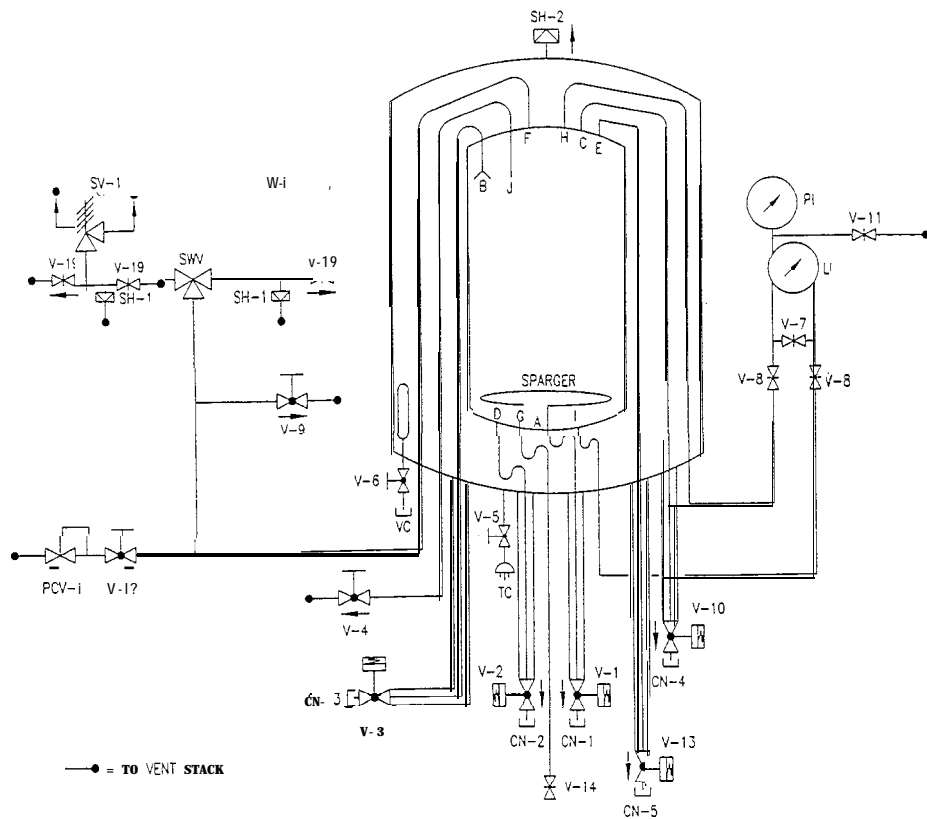

**LEGEND**

- |      |                               |       |                           |
|------|-------------------------------|-------|---------------------------|
| V-1  | RAPID SATURATION FILL SPARGER | V-13  | PUMP RECYCLE              |
| V-2  | LIQUID WITHDRAWAL             | V-14  | VAPOR PRESSURE BULB       |
| V-3  | TOP FILL VALVE                | V-19  | SAFETY TEST VALVE         |
| V-4  | FULL TRYCOCK VALVE            | SWV   | SWITCH VALVE              |
| V-5  | TANK VACUUM GAUGE VALVE       | sv-1  | INNER VESSEL SAFETY VALVE |
| V-6  | TANK EVACUATION VALVE         | PCV-1 | VENT REGULATOR            |
| V-7  | CONTENTS GAUGE BYPASS         | SH-1  | INNER VESSEL HEAD         |
| V-a  | CONTENTS GAUGE SHUTOFF        | SH-2  | OUTER JACKET RELIEF       |
| v-9  | VAPOR VENT VALVE              | LL    | CONTENTS GAUGE            |
| v-10 | VAPOR SHUTOFF VALVE           | PI    | TANK PRESSURE GAUGE       |
| v-11 | INSTRUMENT CIRCUIT VENT VALVE | TC    | VACUUM GAUGE TUBE DV-6R   |
| v-12 | VENT REGULATOR SHUTOFF        | VC    | EVACUATION CONNECTION     |

|   |  |            |
|---|--|------------|
| PARAMETER/TANK VOLUME                     | 15,000   |            |
| MAWP (PSIG/BAR/KPa)                       | 250  | 17.24 1724 |
| WARM WATER VOLUME (GALLONS/LITRES)        | 14,999   | 56,777     |
| NET COLD LIQUID CAPACITY (GALLONS/LITRES) | 13,420   | 50,800     |
| TARE WEIGHT (LBS/KG)                      | 64,000   | 29,030     |
| FULL WEIGHT (LBS/KG), METHANE             | 117,000  | 53,070     |
| NER (%/DAY METHANE)                       | 0.19   |            |
| INNER CONTAINER                           | DESIGNED, MANUFACTURED AND STAMPED IN ACCORDANCE WITH, SECTION VIII DIVISION 1 OF ME ASME BOILER & PRESSURE VESSEL CODE. |            |
| MATERIAL SPECIFICATION                    | SA-353/553 GR 1  |            |
| OPERATING TEMPERATURE RANGE               | -320° TO 100° F<br>-195.5° TO 37.8° C  |            |
| OUTER VESSEL                              |  |            |
| MATERIAL SPECIFICATION                    | W-3 6  |            |
| MAWP - FULL VACUUM (PSIG/BAR/KPa)         | -15  | -1.03 -103 |
| RELIEF - NOT TO EXCEED (PSIG/BAR/KPa)     | 10   | 0.69 69    |

|            |                              |
|------------|------------------------------|
| CONNECTION |                              |
| CN-1       | 1-1/2" RAPID SATURATION FILL |
| CN-2       | 3" LIQUID WITHDRAWAL         |
| CN-3       | 1-1/2" LIQUID TOP FILL       |
| CN-4       | 1" VAPOR SHUT-OFF            |
| CN-5       | 2" PUMP RECYCLE              |

|                          |        |
|--------------------------|--------|
| INTERNAL LINESIZE (PIPE) |        |
| BOTTOM FILL (A)          | 1-1/2" |
| TOP FILL (B)             | 1-1/2" |
| RETURN FLASH GAS (C)     | 1"     |
| PUMP (D)                 | 3"     |
| PUMP RECYCLE (E)         | 2"     |
| SAFETY (F)               | 2"     |
| VAPOR PRESSURE BULB (G)  | 3/8"   |
| INSTRUMENT, VAPOR (H)    | 1/4"   |
| INSTRUMENT, LIQUID (I)   | 3/8"   |
| TRYCOCK (J)              | 3/8"   |

THIS IS A CAD DRAWING DO NOT UPDATE MANUALLY

SHEET 1 OF 2

|   |      |  |
|---|------|--|
| DESIGNED BY   | DATE | TAYLOR-WHARTON   |
| DRAWN BY  | DATE |  |
| CHECKED BY  | DATE | PROJECT NO. 2214835<br>SCALE: N.T.S.<br>SHEET NO. 1 OF 2 |
| GENERAL ARRANGEMENT<br>VT-15000-LNG SANTA<br>CRUZ MTD METROBASE |      |  |

8.018

# SANTA CRUZ METROPOLITAN TRANSIT DISTRICT

**DATE:** September 10, 2004

**TO:** Board of Directors

**FROM:** Frank L. Cheng, Project Manager

**SUBJECT: CONSIDERATION OF AUTHORIZING THE GENERAL MANAGER TO EXECUTE A CONTRACT TO PURCHASE TWO PRESSURE VESSEL ASSEMBLIES FOR THE LCNG FUELING STATION FOR THE METROBASE PROJECT**

## I. RECOMMENDED ACTION

**That the Board of Directors authorize the General Manager to execute a contract for the purchase of two Pressure Vessel Assemblies for the LCNG Fueling Station for the MetroBase Service Facility.**

## II. SUMMARY OF ISSTJES

- In order to assure the completion of the MetroBase Fueling Station in time to meet the requirements of the California Air Resources Board (CARB), METRO is proposing to purchase fueling station components that have a long lead time for delivery in advance of awarding a General Construction Contract.
- On July 22<sup>nd</sup>, 2004, Santa Cruz METRO sent out an Invitation for Bids For Purchase of Two Pressure Vessel Assemblies for the LCNG Fueling Station that is a part of the MetroBase Project.
- On August 23<sup>th</sup>, 2004, METRO received one bid from CP Industries – Division of Reunion Industries.
- METRO has completed the Cost/Price Analysis necessary to meet federal requirement and determined that the bid price is justified..

## III. DISCUSSION

The MetroBase Project consists of three sections; Operations Building, Maintenance Building, and Service Building. Due to the CARR requirements, the Service Building will require items that are long lead items to be purchased in advance of the General Construction Contract. One of the items is a pair of Pressure Vessel Assemblies for the LCNG Fueling Station.

On July 22<sup>nd</sup>, 2004, Santa Cruz METRO sent out an Invitation for Bids For Purchase (IFB) of two pressure vessel assemblies for the CNG Fueling Station. At the end of the thirty (30) day bid period, METRO received one bid from CP Industries – Division of Reunion Industries. Materials required will create a vessel 1' width x 3' height, 20" outside diameter x 11'6" length.

METRO understands that this bid constitutes a firm offer to the District that cannot be withdrawn for 90 calendar days from the date of bid opening. More information on the bid is on Attachment A. Attachment includes Lobbying Certification, Buy America Provision, Bidder DBE Information, Specification Data, and Warranty Information.

As a result of receiving a single bid METRO conducted a Cost/Price Analysis to meet federal requirements and determined that the price contained in the bid is justified.

Staff is recommending that the General Manager be authorized to execute a purchase agreement for two Pressure Vessel Assemblies for the LCNG Fueling Station.

#### **IV. FINANCIAL CONSIDERATIONS**

The pressure vessel assembly for CNG has a unit price of \$37,650. To transport these vessels will result in a freight charge of \$5,700. The total cost for manufacture of the two pressure vessel assemblies, shipping, and sales tax of 8.25% is \$87,212.25.

#### **V. ATTACHMENTS**

**Attachment A: IFB No. 04-03 Recap**



IFB No. 04-03 Recap

|          |  |          | CP Industries - Division of<br>Reunion Industries I |
|----------|--|----------|---|
| Item No. | Item Description                           | Quantity | Unit Price  |
| 1        | Pressure Vessel assemblies for CNG Service | Two      | \$ 37,650.00  |
|          | Extended Price                             |          | \$ 75,300.00  |
| 2        | Sales Tax @ 8.25%                          |          | N/A   |
| 3        | Freight Charges                            |          | \$ 5,700.00   |
| 4        | Total Bid Price                            |          | \$ <b>81,000.00</b>                                 |
| 5        | Delivery                                   |          | 10- 12 weeks after receipt of material              |

9.01

Attachment **A**

**PART I**

**RID FORM**

The undersigned ("Bidder"), upon acceptance by the District, agrees to furnish all labor, freight, transportation, materials, equipment, services, supplies and other work in accordance with the Invitation for Bids entitled Item dated July 26, 2004 at the following prices. The unit bid prices should NOT INCLUDE SALES, USE, EXCISE OR ANY OTHER TAX.

| Item No. | Item Description                           | Quantity | Unit Price | Extended Price    |
|----------|--|----------|------------|-------------------|
| 1        | Pressure Vessel Assemblies for CNG Service | 2        | \$ 37,650  | \$ 75,300         |
| 2        | Sales Tax @ 8.25%                          |          |            | \$ N.A. \$6212.25 |
| 3        | Freight Charges                            |          |            | \$ 5,700          |
| 4        | <b>Total Bid Price</b>                     |          |            | \$ 81,000         |

Manufacturer/Model 1W x 3H, 20" O.D. x 11' 6" L

Delivery of proposed equipment and materials will be \_\_\_\_\_ calendar days after receipt of order.

10 - 12 wks after receipt of material.

The successful bidder obligates him/herself to provide any or all of the bid items at the bid price. District reserves the right to award bid items separately or as a package. District may accept or reject the bid items at its discretion. Award of the bid will be based on totals provided for the Base Items, Options shall not be used in the determination of low bid. The Board of Directors also reserves the right to reject all bids for any reason.

Bidder has examined and is fully familiar with all terms and conditions of the Invitation for Bids and any addenda issued by the District thereto, and Bidder unconditionally submits this bid in strict accordance with said Invitation for Bids. Bidder has carefully checked all words and figures shown on this Bid Form and has carefully reviewed the accuracy of all documents, representations, manufacturer's literature, and statements submitted with this bid.

Bidder understands that this bid constitutes a firm offer to the District that cannot be withdrawn for ninety (90) calendar days from the date of bid opening. If awarded the contract, bidder agrees to deliver to the District executed copies of the final contract and required insurance certificates within ten (10) calendar days of the date of the District Notice of Award. Said Notice of Award shall be deemed duly given to Bidder upon delivery if delivered by hand, or three (3) calendar days after posting if sent by mail to Bidder's address.

Bidder understands that no partial, conditional or qualified bids shall be accepted for any bid item. Bidder further understands the right of the District Board of Directors to accept or reject any or all bids received for any reason. The District reserves the right to waive minor irregularities.

Bidder has included manufacturers' brochures describing the equipment bid under this IFB. Any proposed deviation from any item in the IFB specifications has been delineated on said brochures or on a separate attachment included with the bid. Bidder represents that the equipment and other work bid meets the specifications in all respects unless clearly noted to the contrary in the bid submittal.

The contract, if awarded, will be to the lowest responsive, responsible bidder. Bidder understands that the "lowest responsible bidder" is the lowest bidder whose offer best responds in quality, fitness and capacity to the requirements of the Invitation for Bids. The District reserves the right to award to other than the lowest bidder if the District finds that the lowest bidder is not responsible.

Bidder has full power and authority to enter into and perform the work described in the Invitation for Bids on behalf of the company noted below.

CP INDUSTRIES - DIVISION OF REUNION INDUSTRIES, INC.  
Company Name

Indicate:

Sole Proprietorship      Partnership      Corporation (DIVISION OF)

Joint Venture with \_\_\_\_\_

2214 WALNUT STREET  
streetAddress

MCKEESPORT, PA. 15132  
City, State, Zip Code

Mark Ponist  
Signature of authorized company official

MARK PONIST. TECHNICAL DIRECTOR - CPI SALES  
Typewritten name of above and title

MARK PONIST, TECHNICAL DIRECTOR - CPI SALES, mark.ponist@cp-industries.com  
Name, title, and email address of person to whom correspondence should be directed

66(412)37      (412) 664-6653  
Telephone Number      FAX Number

8-20-04      06-1439715  
Date      Federal Tax ID No.

The Santa Cruz Metropolitan Transit District is a special purpose District and is a subdivision of the State of California.

**LOBBYING CERTIFICATION**  
**(Only for Contracts above \$100,000)**

**Lobbying Certification for Contracts Grants, Loans and Cooperative Agreements (Pursuant to 49 CFR Part 20, Appendix A)**

The undersigned certifies, to the best of his or her knowledge and belief, that:

- (1) No Federal appropriated funds have been paid or will be paid, by or on behalf of the undersigned, to any person for influencing or attempting to influence an officer or employee of an agency, a Member of Congress, an officer or employee of Congress, or an employee of a Member of Congress in connection with the awarding of any Federal Contract, the making of any Federal grant, the making of any Federal loan, the entering into of any cooperative agreement, and the extension, continuation, renewal, amendment, or modification of any Federal Contract, grant, loan, or cooperative agreement.
- (2) If any funds other than Federal appropriated funds have been paid or will be paid to any person for making lobbying contacts to an officer or employee of any agency, a Member of Congress, an officer or employee of Congress, or an employee of a Member of Congress in connection with this Federal Contract, grant, loan, or cooperative agreement, the undersigned shall complete and submit Standard Form--LLL, "Disclosure Form to Report Lobbying," in accordance with its instructions and as amended by "Government wide Guidance for New Restrictions on Lobbying," 61 Fed. Reg. 1413 (1/19/96).
- (3) The undersigned shall require that the language of this certification be included in the award documents for all sub awards at all tiers (including subcontracts, sub grants, and Contracts under grants, loans, and cooperative agreements) and that all sub recipients shall certify and disclose accordingly.

This certification is a material representation of fact upon which reliance was placed when this transaction was made or entered into. Submission of this certification is a prerequisite for making or entering into this transaction imposed by 31 U.S.C. § 1352 (as amended by the Lobbying Disclosure Act of 1995). Any person who fails to file the required certification shall be subject to a civil penalty of not less than \$10,000 and not more than \$100,000 for each such failure.

The Bidder/Offeror certifies or affirms the truthfulness and accuracy of each statement of its certification and disclosure, if any. In addition, the Bidder/Offeror understands and agrees that the provisions of 31 U.S.C. A 3801, et. seq. apply to this certification and disclosure, if any.

Firm Name \_\_\_\_\_

Signature of Authorized Official \_\_\_\_\_

Name and Title of Authorized Official \_\_\_\_\_

Date \_\_\_\_\_

NOT APPLICABLE

**BUY AMERICA PROVISION  
(Only for Contracts above \$100,000)**

This procurement is subject to the Federal Transit Administration Buy America Requirements in 49 CFR part 66.1.

A Buy American Certificate, as per attached format, must be completed and submitted with the bid. A bid which does not include the certificate will be considered non-responsive.

A false certification is a criminal act in violation of 18 U.S.C. 1001. Should this procurement be investigated, the successful bidder/proposer has the burden of proof to establish that it is in compliance.

A waiver from the Buy America Provision may be sought by SCMTD if grounds for the waiver exist.

Section 165(a) of the Surface Transportation Act of 1982 permits FTA participation on this contract only if steel and manufactured products used in the contract are produced in the United States.

**BUY AMERICA CERTIFICATE**

The bidder hereby certifies that it will comply with the requirements of Section 165(a) or (b) (3) of the Surface Transportation Assistance Act of 1982, and the applicable regulations in 49 CFR Part 661.

Date: 8-20-04

Signature: Mark Gorust

Company Name: CP INDUSTRIES

Title: TECHNICAL DIRECTOR - CPI SALES

OR

The bidder hereby certifies that it cannot comply with the requirements of Section 165(a) or (b) (3) of the Surface Transportation Act of 1982, but may qualify for an exception to the requirement pursuant to Section 165(b)(2) or (b)(4) of the Surface Transportation Assistance Act of 1982, as amended, and regulations in 49 CFR 661.7.

Date: \_\_\_\_\_

Signature: \_\_\_\_\_

Company Name: \_\_\_\_\_

Title: \_\_\_\_\_

# BIDDER DBE INFORMATION

BIDDER'S NAME CP INDUSTRIES  
 DBE GOAL FROM CONTRACT \_\_\_\_\_ %  
 FED. NO. \_\_\_\_\_  
 COUNTY \_\_\_\_\_  
 AGENCY \_\_\_\_\_  
 CONTRACT NO. \_\_\_\_\_

BIDDER'S ADDRESS 2214 WALNUT ST.  
MOOREPORT, 15132  
 BID AMOUNT \$ \_\_\_\_\_  
 BID OPENING DATE \_\_\_\_\_  
 DATE OF DBE CERTIFICATON \_\_\_\_\_  
 SOURCE \*\* \_\_\_\_\_

This information must be submitted during the initial negotiations with the District. By submitting a proposal, offeror certifies that he/she is in compliance with the District's policy. Failure to submit the required DBE information by the time specified will be grounds for finding the bid or proposal non-responsive.

| CONTRACT<br>ITEM NO. | ITEM OF WORK AND DESCRIPTION OF<br>WORK OR SERVICES TO BE SUBCONTRACTED<br>OR MATERIALS TO BE PROVIDED * | CERTIFICATION<br>FILE NUMBER | NAME OF DBE | DOLLAR<br>AMOUNT<br>DBE *** | PERCENT<br>DBE |
|----------------------|--|------------------------------|-------------|-----------------------------|----------------|
|                      |  |                              |             |                             |                |

TOTAL CLAIMED DBE PARTICIPATION \$ 0 0 %

Mark Bonist TECHNICAL DIRECTOR - CPI SALES  
 SIGNATURE OF BIDDER

8-20-04  
 DATE

AREA CODE/TELEPHONE (412) 664-6637

(Detach from proposal if DBE information is not submitted with bid.)

- \* If 100% of item is not to be performed or furnished by DBE, describe exact portion, including plan location of work to be performed, of item to be performed or furnished by DBE.
- \*\* DBE's must be certified on the date bids are opened.
- \*\*\* Credit for a DBE supplier who is not a manufacturer is limited to 60% of the amount paid to the supplier.

NOTE: Disadvantaged business must renew their certification annually by submitting certification questionnaires in advance of expiration of current certification. Those not on a current list cannot be considered as certified.

9.06

**BIDDER DBE INFORMATION**

| CONTRACT<br>ITEM NO. | ITEM OF WORK AND DESCRIPTION OF<br>WORK OR SERVICES TO BE SUBCONTRACTED<br>OR MATERIALS TO BE PROVIDED * | CERTIFICATION<br>FILE NUMBER | NAME OF DBE | DOLLAR<br>AMOUNT<br>DBE *** | PERCENT<br>DBE |
|----------------------|--|------------------------------|-------------|-----------------------------|----------------|
|----------------------|--|------------------------------|-------------|-----------------------------|----------------|

TOTAL CLAIMED DBE PARTICIPATION \$ 0 0 %

9.97

The following pressure vessels and assemblies are offered in response to your inquiry. Please refer to our inquiry number on all future correspondence.

**CYI Inquiry Number** C- 29823

Vessel Size: 20" OD x 1.303" MW x 11' 6" Long

Design Temperature: -20 °F to +200 °F

Design Pressure (MAWP): .5500 psig

Operating Pressure: 5000 psig

Capacity per Assembly: 48.0 cu. ft. water volume  
17,133 scf of CNG @ 5000 psig

Mounting Configuration: 1 wide x 3 high

Seismic Zone 4 Bracing: X Yes \_\_ No

Assembly Weight: 17,133 lbs.

Assembly Price: US\$ 40,500 each FOB Santa Cruz, CA

**Delivery:** 10 to 12 weeks after receipt of material, now scheduled for the week of November 29, 2004. This is based on our current mill schedule and is subject to change without notice. A firm delivery date will be established upon receipt of an order.

**Terms:** Net 30 Days or as arranged with CPI Treasury, subject of credit approval. Please refer to attached CPI conditions and warranty.

Vessels and Assemblies are manufactured according to attached "Specification Data" and CAL-OSHA, Title 8 requirements. Assemblies do not include safety relief valve vent pipes.

Due to escalating rates from our steel supplier and a very tight supply of products, prices quoted are based upon steel prices and surcharges in effect on the date of this quotation. All orders are subject to market prices and surcharges in effect at the time of order.

Freight will be billed at actual cost and include any fuel surcharges in effect at time of shipment.

9.98



The buyer is responsible for seismic analysis of a 2 wide x 3 high assembly.

Vessel signs per NFPA 704 are not included.

CPI will submit an assembly drawing, designed to NFPA-52 and California Code of Regulations, Title 8, for approval after receipt of an order. The buyer is responsible for compliance of this design in accordance with 2002 NFPA-52 and 2001 Title 8 requirements.

The set point of vessel safety relief valves will be 5500 psig in accordance with ASME Code requirements.

9.09

**CP INDUSTRIES**  
A Division of Reunion Industries, Inc.

**SPECIFICATION DATA**

Seamless pressure vessels are manufactured to the ASME UPV Code Section VIII Division 1 Appendix 22 Safety Factor 3: 1 for dry gas, non-corrosive service.

Vessels are horizontally mounted in I-beam frames to minimize rust and maintenance.

Each vessel in the assembly will be furnished with a 1/2" full port stainless steel ball valve on the front, a spring loaded safety relief valve on the rear with a full port 3/4" stainless steel ball valve between the vessel and the safety relief valve, and a dome outlet drain valve. All safety relief valves are braced to meet manufacturers recommendation. The entire unit will be painted with epoxy primer and a white urethane final coat.

When evaluating this proposal, be it for completed assemblies or single vessels, the user/installer should be aware of the following.

Since the natural gas fuel may not be dried to meet the requirements of SAE J16 16, consideration must be given to the effects that condensed water, combined with certain natural gas constituents, may have on cascade storage vessels. It is well known that a correlation exists between high ultimate tensile strengths (UTS), hydrogen sulfide (H<sub>2</sub>S) stress corrosion cracking and hydrogen (H<sub>2</sub>) embrittlement. CPI has, therefore, imposed a maximum UTS of 135,000 PSI for vessels used in CNG service and has subjected the steel to design qualification sulphide stress cracking tests made in accordance with Clause 14.3 of CSA Standard B5 1-97, Part 2. End plugs (either forged or machined from bar stock) utilize a material that is also capable of meeting, as a minimum, the same toughness requirement imposed on the vessel material by the ASME Code. Furthermore, the plug material has the same maximum UTS which precludes susceptibility to H<sub>2</sub> embrittlement or sulfide stress cracking.

The ASME Code requires that all quenched and tempered (Q&T) forged steel pressure vessels be examined by liquid penetrant or magnetic particle inspection. The Code does not require an angle beam ultrasonic (UT) inspection. The magnetic particle inspection method is used by most manufacturers due to its ease of implementation. This inspection has been specified to find quench cracks and will not detect deep, subsurface, midwall, or internal surface defects. An angle beam ultrasonic inspection to a 5% notch calibration ensures that no defects exceeding 5% of the minimum wall thickness are present after fabrication, thus greatly diminishing the possibility of H<sub>2</sub>S embrittlement. CP Industries performs an angle beam IIT inspection in addition to magnetic particle inspection on all ASME pressure vessels used in natural gas service.

NFPA 52, Section 2-9.1 (1998 edition) and The Railroad Commission of Texas CNG Regulations specify that shut-off valves must be capable of withstanding a hydrostatic test of at least four times the rated service pressure without rupture. All valves used on CPI pressure vessels and assemblies meet a safety factor of 4: 1.

## Warranty Conditions

CP Industries, Inc. ("Seller") shall manufacture material as ordered by Buyer and identified in Seller's written sales order (the "Product") in accordance with the designs and detailed specifications as approved by the Buyer, and warrant the Product to be free of defects in material and workmanship for a period of one (1) year from the date of delivery to the Buyer, provided the Product is operated under normal use and service conditions consistent with its design and specifications.

This Warranty is contingent upon: (1) The Seller promptly receiving notification from the Buyer of any problem or difficulty being experienced with the Product, including a detailed description of such problem; and (2) No modification or change to the Product being made without prior written approval of the Seller. Seller accepts no responsibility for service or repair work done without the prior written authority of Seller. Any service or repair work done without such written authority of Seller shall cause the Warranty to be void.

If the Product covered by this Warranty is found by Seller or Seller's authorized representative to be defective, then the Product will be repaired or replaced at Seller's expense.

This Warranty is non-transferable without the prior written consent of Seller.

In no event shall Seller be liable for personal injury, property damage, loss of profit, delay, or any incidental or consequential damages whether arising from any express or implied warranty, including, but not limited to, the implied warranties of merchantability or fitness for a particular purpose.

No warranty of fitness for any particular purpose nor any other representation or warranty, whether express or implied, is made respecting said product, or the production thereof and there are no warranties which extend beyond the description herein.

*9. all*

## CONDITIONS

- 1 PAYMENTS: Payments shall be made at par in legal tender of the United States of America. Buyer shall make such arrangements for payment as Seller shall from time to time reasonably require and Seller may suspend production, shipment or delivery until such arrangements are made. In the event Buyer fails to make payment in full within the time period set forth on the invoice or within the time period expressly agreed upon in writing by the parties, such failure to pay on time constitutes a material breach of contract by Buyer permitting Seller to suspend production, shipment or delivery under this or any other contract between Buyer and Seller and Buyer shall pay to seller interest on the unpaid amount at the maximum rate permitted by law or the Prime Rate in effect by Morgan Guaranty Trust Company on the first of the month for each month plus 3.5%, whichever is less, and Seller shall have, in addition, all other remedies permitted to Seller by law, equity and this contract. If Seller has to take legal action to collect any amount due hereunder, Buyer shall pay all court costs plus reasonable attorney's fees incurred by Seller in bringing such legal action.
- 2 TAXES: To the extent legally permissible, all present and future taxes imposed by any Federal, state, foreign or local authority which Seller may be required to pay or collect upon or with reference to the sale, purchase, transportation, delivery, storage, use or consumption of goods or services, including taxes upon or measured by the receipts therefrom (except net, income and equity franchise taxes) shall be for account of Buyer.
- 3 TITLE; INCIDENTAL TRANSPORTATION AND STORAGE CHARGES: Unless otherwise agreed, title to goods and risk of loss shall pass to Buyer upon tender of delivery at the FOB point, specified Any charges at destination for spotting, switching, handling charge for goods left in Seller's possession after notification to Buyer that the goods are available to ship.
- 4 TIME OF SHIPMENT AND SHIPPING: Time is not of the essence hereunder. Each shipment is to be considered a separate sale. Seller reserves the right to ship all or any part of the goods from any shipping point of CP INDUSTRIES, Inc. other than the shipping point or points specified herein.
- 5 SPECIFICATION VARIATIONS: Except in the particulars specified by Buyer and expressly agreed to in writing signed by Seller, the goods furnished hereunder shall be produced in accordance with Seller's standard practices. All goods however, including those produced to meet an exact specification, shall be subject to Seller's mill tolerances and variations consistent with good mill practice in respect to demension, weight straightness, section Composition and mechanical or physical properties, and to normal variations in surface and internal conditions and in quality; to deviations from tolerances and variations consistent with practical testing and inspection methods and to regular mill practice on over and under shipments.
- 6 INSPECTION: Where mill inspection is made by Buyer, Buyer's inspector shall be deemed the agent of Buyer with authority to waive specified tests and details of test procedure and to accept goods as conforming to this contract with respect to all characteristics of such goods for which such inspection is made.
- 7 FORCE MAJEURE; ALLOCATION OF PRODUCTION: In the event either party's performance hereunder is delayed or made impossible, or commercially impracticable due to causes such as fire, explosion, strike or other difference with workers, shortage of energy sources, facility, material or labor, delay in or lack of transportation, temporary or permanent plant shutdown, breakdown or accident, compliance with other action taken to carry out the intent or purpose of any law, regulation or other requirement of any governmental authority, or any cause beyond control, that party shall have such additional time within which to perform this contract as may be reasonably necessary under the circumstances. However, the obligation of Buyer to pay for goods delivered is never suspended. In addition, if due to force majeure or any other use, Seller is unable to produce sufficient goods to meet all demands from customers and internal uses, Seller shall have the right to allocate production amount to its customers and plants in any manner which Seller may determine to be equitable.
- 8 PATENT INDEMNITY: Seller shall indemnify Buyer(s) for all direct and actual damages recovered from Buyer by a third party in a legal action for infringement of a U.S. Patent claim covering goods furnished hereunder, on condition that Buyer promptly notifies Seller of the alleged infringement, affords Seller the opportunity to assume defense thereof, and cooperates with Seller in defense of the action and in any feasible mitigation of damages; and (1) for Buyer's directly and reasonably incurred expenses in defending such legal action if, after such notice and opportunity given by Buyer, Seller elects not to assume such defense, provided that such election by Seller shall not otherwise affect Buyer's afore said obligations. In like manner, Buyer shall indemnify Seller, and Seller's indemnity of Buyer hereunder shall not apply, with respect to a claim arising out of Seller's compliance with special designs or specifications furnished by Buyer, now or hereafter forming a part of this contract, or with other written instructions given by Buyer for the purpose of directing the manner in which Seller shall perform this contract. In no event shall a party hereto have any liability hereunder for indirect or consequential losses or damages suffered, or other expenses incurred by the other party hereto or any third party by reason of any patent infringement claim.
- 9 WARRANTY; DISCLAIMERS: SELLER WARRANTS THAT THE GOODS FURNISHED HEREUNDER WILL, BE PRODUCED AND DELIVERED IN ACCORDANCE WITH THE SPECIFICATIONS SET FORTH ON THE FACE THEREOF HOWEVER NO WARRANTY OR WARRANTY OF FITNESS FOR ANY PARTICULAR PURPOSE NOR ANY OTHER REPRESENTATION OR WARRANTY, WHETHER EXPRESS OR IMPLIED, IS MADE RESPECTING SAID GOODS, OR THE PRODUCTION THEREOF AND THERE ARE NO WARRANTIES WHICH EXTEND BEYOND THE DESCRIPTION ON THE FACE HEREOF.
10. LIMITATION OF REMEDIES: Seller will replace, at the delivery point specified herein, any goods furnished hereunder that are found to be defective or otherwise fail to conform to any warranty or this contract or, at Seller's option, Seller will repay the price paid for such goods, plus any transportation charges paid by Buyer in addition to such price. Claims must be made promptly following delivery of the goods to Buyer and Seller must be given a reasonable opportunity to investigate and cure any nonconformance. Buyer's exclusive remedies with respect to any goods furnished by Seller hereunder that are found to be defective or otherwise not in conformity with any warranty or this contract shall be limited exclusively to the right to replacement thereof or to repayment of the price, as above provided Seller's liability for any other breach of this contract shall be limited to the difference between the delivered price of the goods covered hereby and the market price of such goods at Buyer's destination at the time of such breach.  
IN NO EVENT SHALL SELLER BE LIABLE FOR PERSONAL INJURY, PROPERTY DAMAGE, LOSS OF PROFIT, DELAY OR ANY INCIDENTAL OR CONSEQUENTIAL DAMAGES WHETHER ARISING FROM CONTRACT, BREACH OF CONTRACT, TORT, SELLER'S NEGLIGENCE, STRICT LIABILITY OR ANY EXPRESS OR IMPLIED WARRANTY, INCLUDING BUT NOT LIMITED TO THE IMPLIED WARRANTIES OF MERCHANTABILITY OR FITNESS FOR A PARTICULAR PURPOSE.
- 11 EXCLUSIVE TERMS AND CONDITIONS; ACCEPTANCE; MODIFICATION: No terms or conditions other than those stated herein and no agreement or understanding, oral or written, in any way purporting to modify these terms and conditions shall be binding on Seller unless hereafter made in writing, specifically stating that it is a modification of these terms and conditions, and signed by Seller's authorized representative. If these conditions and this form constitute Seller's acceptance of Buyer's order, then this acceptance is expressly made conditional on Buyer's assent to these conditions as the only conditions for this sale. Acceptance of the products sold hereunder by Buyer shall constitute assent to these conditions and Seller hereby objects to and rejects any and all additional or different terms proposed by Buyer, whether contained in Buyer's purchase order or shipping release forms, or elsewhere. All proposals, negotiations and representations if any, made prior and with reference hereto are merged herein.
- 12 CONDITIONS INCORPORATED BY REFERENCE: Any clause required to be included in a contract of this type by any applicable law or administrative regulation having the effect of law shall be deemed to be incorporated herein.
- 13 WAIVER: Waiver by Seller or Buyer of any breach of these provisions shall not be construed as a waiver of any other breach.
- 14 ASSIGNMENT: Neither party may assign its rights or obligations hereunder without the prior written consent of the other party.
- 15 TITLES: The titles used in these Conditions are for convenience of reference only and are not to be considered in interpreting the substance of the condition.

9.012

# SANTA CRUZ METROPOLITAN TRANSIT DISTRICT

**DATE:** September 10, 2004

**TO:** Board of Directors

**FROM:** Tom Stickel, Manager of Fleet Maintenance

**SUBJECT: CONSIDERATION OF AWARD OF CONTRACT WITH DESMOND, MARCELLO & AMSTER FOR GOODWILL APPRAISAL SERVICES FOR THE METROBASE PROPERTIES**

## I. RECOMMENDED ACTION

**It is recommended that the Board of Directors authorize the General Manager to enter into a contract with Desmond, Marcello & Amster for goodwill appraisal services for the MetroBase Properties.**

## II. SUMMARY OF ISSUES

- A competitive procurement was conducted to solicit proposals from qualified firms.
- Two firms submitted proposals for the District's review.
- A five-member evaluation committee reviewed and evaluated the proposals.
- The evaluation committee is recommending that a contract be established with Desmond, Mar-cello & Amster to provide goodwill appraisal services for the MetroBase Properties.

## III. DISCUSSION

The Santa Cruz Metropolitan Transit District (District) has adopted a "Resolution of Necessity" in order to initiate eminent domain proceedings to acquire property located at 120 Golf Club Drive, Santa Cruz and has purchased 1122 River Street, Santa Cruz. In order to evaluate potential loss of goodwill claims, District requested proposals from qualified goodwill loss appraisers.

On August 12, 2004, proposals were received and opened from two (2) firms. These firms are listed in Attachment A. A five-member evaluation committee comprised of District staff and Marty Ackerman of the City of Santa Cruz Redevelopment Agency reviewed and evaluated the proposals. The evaluation committee used the following criteria as contained in the Request for Proposals:

| <b>Proposal Evaluation Scoring</b>       | <b>Points Possible</b> |
|--|------------------------|
| Consultant's Qualifications & Experience | 50                     |
| References                               | 25                     |
| Project Cost Estimate                    | 20                     |
| DBE Involvement                          | 5                      |
| Total Possible Points                    | 100                    |

The evaluation committee is recommending that the Board of Directors authorize the General Manager to enter into a contract with Desmond, Marcello & Amster to provide goodwill loss appraisal services for an amount not to exceed \$37,500. Contractor will provide services meeting all District specifications and requirements.

#### **IV. FINANCIAL CONSIDERATIONS**

Funding for this contract is contained in the MetroBase Budget.

#### **V. ATTACHMENTS**

**Attachment A:** List of Firms Responding to the Request for Proposals

**Attachment B:** Contract with Desmond, Marcello & Amster

**The RFP along with its Exhibits and any Addendums are available for review at the Administration Office of METRO or online at [www.scmttd.com](http://www.scmttd.com)**

List of Firms Responding to the Request for Proposal

1. Desmond, Marcello & Amster of San Francisco, California
2. Sanli Pastore & Hill, Inc. of Sacramento, California

PROFESSIONAL SERVICES CONTRACT  
FOR GOODWILL LOSS APPRAISAL SERVICES (04-02)

THIS CONTRACT is made effective on \_\_\_\_\_, 2004 between the SANTA CRUZ METROPOLITAN TRANSIT DISTRICT, a political subdivision of the State of California ("District"), and DESMOND, MARCELLO & AMSTER ("Contractor").

1. RECITALS

1.01 District's Primary Objective

District is a public entity whose primary objective is providing public transportation and has its principal office at 370 Encinal Street, Suite 100, Santa Cruz, California 95060.

1.02 District's Need for Goodwill Loss Appraisal Services

District has the need for Goodwill Loss Appraisal Services. In order to obtain these services, the District issued a Request for Proposals, dated July 22, 2004, setting forth specifications for such services. The Request for Proposals is attached hereto and incorporated herein by reference as Exhibit "A".

1.03 Contractor's Proposal

Contractor is a firm/individual qualified to provide Goodwill Loss Appraisal Services and whose principal place of business is 225 Bush Street, 16<sup>th</sup> Floor, San Francisco CA 94104. Pursuant to the Request for Proposals by the District, Contractor submitted a proposal for Goodwill Loss Appraisal Services, which is attached hereto and incorporated herein by reference as Exhibit "B."

1.04 Selection of Contractor and Intent of Contract

On \_\_\_\_\_, District selected Contractor as the offeror whose proposal was most advantageous to the District, to provide the Goodwill Loss Appraisal Services described herein. This Contract is intended to fix the provisions of these services.

District and Contractor agree as follows:

2. INCORPORATED DOCUMENTS AND APPLICABLE LAW

2.01 Documents Incorporated in this Contract

The documents below are attached to this Contract and by reference made a part hereof. This is an integrated Contract. This writing constitutes the final expression of the parties' contract, and it is a complete and exclusive statement of the provisions of that Contract, except for written amendments, if any, made after the date of this Contract in accordance with Section 13.14.

A. Exhibit "A"

Santa Cruz Metropolitan Transit District's "Request for Proposals" dated July 22, 2004

B. Exhibit "B" (Contractor's Proposal)

Contractor's Proposal to the District for Goodwill Loss Appraisal Services signed by Contractor and dated August 12, 2004.



2.02 Conflicts

Where in conflict, the provisions of this writing supersede those of the above-referenced documents, Exhibits "A" and "B". Where in conflict, the provisions of Exhibit "A" supercede Exhibit "B".

2.03 Recitals

The Recitals set forth in Article 1 are part of this Contract.

3. DEFINITIONS

3.01 General

The terms below (or pronouns in place of them) have the following meaning in the contract:

3.01.01 CONTRACT - The Contract consists of this document, the attachments incorporated herein in accordance with Article 2, and any written amendments made in accordance with Section 13.14.

3.01.02 CONTRACTOR - The Contractor selected by District for this project in accordance with the Request for Proposals issued July 22, 2004.

3.01.03 CONTRACTOR'S STAFF - Employees of Contractor.

3.01.04 DAYS - Calendar days.

3.01.05 OFFEROR - Contractor whose proposal was accepted under the terms and conditions of the Request for Proposals issued July 22, 2004.

3.01.06 PROVISION - Any term, agreement, covenant, condition, clause, qualification, restriction, reservation, or other stipulation in the contract that defines or otherwise controls, establishes, or limits the performance required or permitted by either party.

3.01.07 SCOPE OF WORK (OR "WORK") - The entire obligation under the Contract, including, without limitation, all labor, equipment, materials, supplies, transportation, services, and other work products and expenses, express or implied, in the Contract.

4. TIME OF PERFORMANCE

4.01 Term

The term of this Contract will be for a period not to exceed one (1) year or until completion of duties and responsibilities and shall commence upon the issuance of the contract by the District.

At the option of the District, this contract agreement may be renewed for four (4) additional one (1) year terms upon mutual written consent.

5. COMPENSATION

5.01 Terms of Payment

District shall compensate Contractor in an amount not to exceed the amounts/rates agreed upon by the District. District shall reasonably determine whether work has been successfully performed for purposes of payment. Compensation shall be made within forty-five (45) days of District

written approval of Contractor's written invoice for said work. Contractor understands and agrees that if he/she exceeds the \$37,500 maximum amount payable under this contract, that it does so at its own risk.

5.02 Invoices

Contractor shall submit invoices with a project number provided by the District on a monthly basis. Contractor's invoices shall include detailed records showing actual time devoted, work accomplished, date work accomplished, personnel used, and amount billed per hour. Expenses shall only be billed if allowed under the Contract. Telephone call expenses shall show the nature of the call and identify location and individual called. Said invoice records shall be kept up-to-date at all times and shall be available for inspection by the District (or any grantor of the District, including, without limitation, any State or Federal agency providing project funding or reimbursement) at any time for any reason upon demand for not less than four (4) years after the date of expiration or termination of the Contract. Under penalty of law, Contractor represents that all amounts billed to the District are (1) actually incurred; (2) reasonable in amount; (3) related to this Contract; and (4) necessary for performance of the project.

6. NOTICES

All notices under this Contract shall be deemed duly given upon delivery, if delivered by hand; or three (3) days after posting, if sent by registered mail, receipt requested; to a party hereto at the address hereinunder set forth or to such other address as a party may designate by notice pursuant hereto.

DISTRICT

Santa Cruz Metropolitan Transit District  
370 Encinal Street  
Suite 100  
Santa Cruz, CA 95060  
Attention: General Manager

CONTRACTOR

Desmond, Marcello & Amster  
225 Bush Street, 16<sup>th</sup> Floor  
San Francisco CA 94104  
Attention: Ricardo Goni, Senior Manager

7. AUTHORITY

Each party has full power and authority to enter into and perform this Contract and the person signing this Contract on behalf of each has been properly authorized and empowered to enter into this Contract. Each party further acknowledges that it has read this Contract, understands it, and agrees to be bound by it.

Signed on \_\_\_\_\_

DISTRICT  
SANTA CRUZ METROPOLITAN TRANSIT DISTRICT

\_\_\_\_\_  
Leslie R. White  
General Manager

CONTRACTOR

By \_\_\_\_\_

Approved as to Form:

\_\_\_\_\_  
Margaret Rose Gallagher  
District Counsel

# **SANTA CRUZ METROPOLITAN TRANSIT DISTRICT**

---

## **Request for Proposals (RFP) For Goodwill Loss Appraisal Services**

**District RFP NO. 04-02**

**Date Issued: July 22, 2004**

**Proposal Deadline: 5:00 P.M., August 12, 2004**

---



### **Contents of this RFP**

- I. Instructions to Offerors
- II. General Information Form
- III. Specifications
- IV. General Conditions
- V. Contract/Agreement
- VI. FTA Requirements for Non-Construction Contracts
- VII. Protest Procedures

## **PART I**

### **INSTRUCTIONS TO OFFERORS**

1. **GENERAL:** These instructions form a part of the contract documents and shall have the same force as any other portion of the contract. Failure to comply may subject the proposal to immediate rejection.
2. **OFFEROR RESPONSIBILITY:** The District has made every attempt to provide all information needed by offerors for a thorough understanding of project terms, conditions, and requirements. It is expressly understood that it is the responsibility of offerors to examine and evaluate the work required under this RFP and the terms and conditions under which the work is performed. By submitting a proposal, Offeror represents that it has investigated and agrees to all terms and conditions of this RFP.
3. **DELIVERY OF PROPOSALS TO THE DISTRICT:** Proposals (1 original and 4 copies) must be delivered to the District Purchasing Office, 120 Dubois Street, Santa Cruz, California, 95060 on or before the deadline noted in the RFP.

Any contract or purchase order entered into as a result of this RFP shall incorporate the RFP and the proposal submitted by successful offeror. In the event of conflict between the proposal and any other contract document, the other contract document shall prevail unless specified otherwise by the District. Telephone or electronic proposals will not be accepted.

4. **LATE PROPOSALS:** Proposals received after the date and time indicated herein shall not be accepted and shall be returned to the Offeror unopened.

Requests for extensions of the proposal closing date or time will not be granted. Offerors mailing proposals should allow sufficient mail time to ensure timely receipt of their proposals before the deadline, as it is the offerors responsibility to ensure that proposals arrive before the closing time.

5. **MULTIPLE PROPOSALS:** An offeror may submit more than one proposal. At least one of the proposals shall be complete and comply with all requirements of this RFP. However, additional proposals may be in abbreviated form, using the same format, but providing only the information that differs in any way from the information contained in the master proposal. Master proposals and alternate proposals should be clearly labeled.
6. **PARTIAL PROPOSALS:** No partial proposals shall be accepted.
7. **WITHDRAWAL OR MODIFICATION OF PROPOSALS:** Proposals may not be modified after the time and date proposals are opened. Proposals may be withdrawn by Offeror before proposal opening upon written request of the official who is authorized to act on behalf of the Offeror.
8. **CHANGES TO THE RFP RECOMMENDED BY OFFERORS:** All requests for clarification or modification of the RFP shall be made in writing. Offerors are required to provide the value of each proposed modification and a brief explanation as to why the change is requested. Value shall be defined as the cost or savings to the District and the advantage to the District of the proposed change.
9. **ADDENDA:** Modifications to this RFP shall be made only by written addenda issued to all RFP holders of record. Verbal instructions, interpretations, and changes shall not serve as official expressions of the District, and shall not be binding. All cost adjustments or other changes resulting from said addenda shall be taken into consideration by offerors and included in their proposals.
10. **OFFEROR'S PROPOSAL TO THE DISTRICT:** Offerors are expected to thoroughly examine the scope of work and terms and conditions of the RFP. Offerors' terms, conditions, and prices shall constitute a firm offer to the District that cannot be withdrawn by the Offeror for ninety (90) calendar days after the closing date for

proposals, unless a longer time period is specified by the District in the RFP. Offerors shall identify all proprietary information in their proposals. Information identified as proprietary shall not be made available to the public or other offerors.

11. **SINGLE OFFEROR RESPONSIBILITY:** Single Offeror responsibility is required under this RFP. Each Offeror responding to this RFP must respond to all professional services and provide all materials, equipment, supplies, transportation, freight, special services, and other work described or otherwise required herein.
12. **EXPERIENCE AND QUALIFICATIONS:** Offeror may be required upon request of the District to substantiate that Offeror and its proposed subcontractors have the skill, experience, licenses, necessary facilities, and financial resources to perform the contract in a satisfactory manner and within the required time.
13. **SUBCONTRACTING:** The requirement for single-point responsibility does not prohibit subcontracts or joint ventures provided that the single successful Offeror assumes the following responsibilities: (1) serves as the sole general contractor with the District; (2) assumes full responsibility for the performance of all its subcontractors, joint venturers, and other agents; (3) provides the sole point of contact for all activities through a single individual designated as project manager; (4) submits information with its proposal documenting the financial standing and business history of each subcontractor or joint venturer; and, (5) submits copies of all subcontracts and other agreements proposed to document such arrangement.

Without limiting the foregoing, any such legal documents submitted under item "5" above must (a) make the District a third-party beneficiary thereunder; (b) grant to the District the right to receive notice of and cure any default by the successful offeror under the document; and (c) pass through to the District any and all warranties and indemnities provided or offered by the subcontractor or similar party.

14. **EVALUATION CRITERIA AND AWARD OF CONTRACT:** The award of the contract will be made to the responsible Offeror whose proposal is most advantageous to the District. Specific evaluation criteria are identified in the Specifications section of the RFP.
15. **DISTRICT'S PREROGATIVE:** The District reserves the right to contract with any single firm or joint venture responding to this RFP (without performing interviews), based solely upon its evaluation and judgment of the firm or joint venture in accordance with the evaluation criteria. This RFP does not commit the District to negotiate a contract, nor does it obligate the District to pay for any costs incurred in preparation and submission of proposals or in submission of a contract.

The District reserves and holds at its discretion the following rights and options in addition to any others provided by the Public Utility Code, Section 98000 and the Public Contract Code: (1) to reject any or all of the proposals; (2) to issue subsequent requests for proposals; (3) to elect to cancel the entire request for proposals; (4) to waive minor informalities and irregularities in proposals received; (5) to enter into a contract with any combination of one or more prime contractors, subcontractors, or service providers; (6) to approve or disapprove the use of proposed subcontractors and substitute subcontractors; (7) to negotiate with any, all, or none of the respondents to the RFP.

16. **EXECUTION OF CONTRACT:** The final contract shall be executed by the successful offeror and returned to the District Administrative Office no later than ten (10) calendar days after the date of notification of award by the District. All required bonds and insurance certificates shall also be submitted by this deadline. In the event successful offeror does not submit any or all of the aforementioned documents on or before the required deadline, the District may award the contract to another offeror; in such event, District shall have no liability and said party shall have no remedy of any kind against the District.
17. **DISADVANTAGED AND WOMEN'S BUSINESS ENTERPRISES:** The Board of Directors of the Santa Cruz Metropolitan Transit District has adopted a Disadvantaged Business Enterprise Policy to promote the participation of disadvantaged business enterprises (DBE) in all areas of District contracting to the maximum extent practicable. Consistent with the DBE Policy, the successful offeror selected for this project shall take all necessary and reasonable steps to ensure that DBE firms have the maximum practicable opportunity to participate in the performance of this project and any subcontracting opportunities thereof.

18. NONDISCRIMINATION: The Santa Cruz Metropolitan Transit District will not discriminate with regard to race, color, creed, ancestry, national origin, religion, sex, sexual preference, marital status, age, medical condition or disability in the consideration for award of contract.

***ADDITIONAL INSTRUCTIONS TO OFFERORS ARE SET FORTH IN  
OTHER SECTIONS OF THIS REQUEST FOR PROPOSALS***

**PART II**

**GENERAL INFORMATION FORM**

**GOODWILL LOSS APPRAISAL SERVICES, RFP NO. 04-02**

(To be completed by the offeror and placed at the front of your proposal)

\_\_\_\_\_  
Legal Name of Firm Date

\_\_\_\_\_  
Firm's Address

\_\_\_\_\_  
Telephone Number FAX Number

\_\_\_\_\_  
Type of Organization (Partnership, Corporation, etc.) Tax ID Number

Offeror understands and agrees that, by his/her signature, if awarded the contract for the project, he/she is entering into a contract with the District that incorporates the terms and conditions of the entire Request for Proposals package, including the General Conditions section of the Request for Proposals. Offeror understands that this proposal constitutes a firm offer to the District that cannot be withdrawn for ninety (90) calendar days from the date of the deadline for receipt of proposals. If awarded the contract, offeror agrees to deliver to the District the required insurance certificates within ten (10) calendar days of the Notice of Award.

\_\_\_\_\_  
Signature of Authorized Principal

\_\_\_\_\_  
Name of Principal-in-Charge and Title

\_\_\_\_\_  
Name of Project Manager and Title

\_\_\_\_\_  
Name, Title, Email Address and Phone Number of Person To Whom Correspondence Should be Directed

\_\_\_\_\_  
Addresses Where Correspondence Should Be Sent

\_\_\_\_\_  
Areas of Responsibility of Prime Contractor



Listing of major sub consultants proposed (if applicable), their phone numbers, and areas of responsibility (indicate which firms are DBE's):

---

---

---

---

---

**LOBBYING CERTIFICATION**  
**(Only for Contracts above \$100,000)**

**Lobbying Certification for Contracts Grants, Loans and Cooperative Agreements (Pursuant to 49 CFR Part 20, Appendix A)**

The undersigned certifies, to the best of his or her knowledge and belief, that:

- (1) No Federal appropriated funds have been paid or will be paid, by or on behalf of the undersigned, to any person for influencing or attempting to influence an officer or employee of an agency, a Member of Congress, an officer or employee of Congress, or an employee of a Member of Congress in connection with the awarding of any Federal Contract, the making of any Federal grant, the making of any Federal loan, the entering into of any cooperative agreement, and the extension, continuation, renewal, amendment, or modification of any Federal Contract, grant, loan, or cooperative agreement.
- (2) If any funds other than Federal appropriated funds have been paid or will be paid to any person for making lobbying contacts to an officer or employee of any agency, a Member of Congress, an officer or employee of Congress, or an employee of a Member of Congress in connection with this Federal Contract, grant, loan, or cooperative agreement, the undersigned shall complete and submit Standard Form--LLL, "Disclosure Form to Report Lobbying," in accordance with its instructions and as amended by "Government wide Guidance for New Restrictions on Lobbying," 61 Fed. Reg. 1413 (1/19/96).
- (3) The undersigned shall require that the language of this certification be included in the award documents for all sub awards at all tiers (including subcontracts, sub grants, and Contracts under grants, loans, and cooperative agreements) and that all sub recipients shall certify and disclose accordingly.

This certification is a material representation of fact upon which reliance was placed when this transaction was made or entered into. Submission of this certification is a prerequisite for making or entering into this transaction imposed by 31 U.S.C. § 1352 (as amended by the Lobbying Disclosure Act of 1995). Any person who fails to file the required certification shall be subject to a civil penalty of not less than \$10,000 and not more than \$100,000 for each such failure.

The Bidder/Offeror certifies or affirms the truthfulness and accuracy of each statement of its certification and disclosure, if any. In addition, the Bidder/Offeror understands and agrees that the provisions of 31 U.S.C. A 3801, et. seq. apply to this certification and disclosure, if any.

Firm Name \_\_\_\_\_

Signature of Authorized Official \_\_\_\_\_

Name and Title of Authorized Official \_\_\_\_\_

Date \_\_\_\_\_

**BUY AMERICA PROVISION  
(Only for Contracts above \$100,000)**

This procurement is subject to the Federal Transit Administration Buy America Requirements in 49 CFR part 661.

A Buy American Certificate, as per attached format, must be completed and submitted with the bid. A bid which does not include the certificate will be considered non-responsive.

A false certification is a criminal act in violation of 18 U.S.C. 1001. Should this procurement be investigated, the successful bidder/proposer has the burden of proof to establish that it is in compliance.

A waiver from the Buy America Provision may be sought by SCMTD if grounds for the waiver exist.

Section 165(a) of the Surface Transportation Act of 1982 permits FTA participation on this contract only if steel and manufactured products used in the contract are produced in the United States.

**BUY AMERICA CERTIFICATE**

The bidder hereby certifies that it will comply with the requirements of Section 165(a) or (b) (3) of the Surface Transportation Assistance Act of 1982, and the applicable regulations in 49 CFR Part 661.

Date: \_\_\_\_\_

Signature: \_\_\_\_\_

Company Name: \_\_\_\_\_

Title: \_\_\_\_\_

OR

The bidder hereby certifies that it cannot comply with the requirements of Section 165(a) or (b) (3) of the Surface Transportation Act of 1982, but may qualify for an exception to the requirement pursuant to Section 165(b)(2) or (b)(4) of the Surface Transportation Assistance Act of 1982, as amended, and regulations in 49 CFR 661.7.

Date: \_\_\_\_\_

Signature: \_\_\_\_\_

Company Name: \_\_\_\_\_

Title: \_\_\_\_\_

# CONTRACTOR DBE INFORMATION

CONTRACTOR'S NAME \_\_\_\_\_  
 DBE GOAL FROM CONTRACT \_\_\_\_\_ %  
 FED. NO. \_\_\_\_\_  
 COUNTY \_\_\_\_\_  
 AGENCY \_\_\_\_\_  
 CONTRACT NO. \_\_\_\_\_

CONTRACTOR'S ADDRESS \_\_\_\_\_  
 \_\_\_\_\_  
 PROPOSAL AMOUNT \$ \_\_\_\_\_  
 PROPOSAL OPENING DATE \_\_\_\_\_  
 DATE OF DBE CERTIFICATON \_\_\_\_\_  
 SOURCE \*\* \_\_\_\_\_

This information must be submitted during the initial negotiations with the District. By submitting a proposal, offeror certifies that he/she is in compliance with the District's policy. Failure to submit the required DBE information by the time specified will be grounds for finding the proposal non-responsive.

| CONTRACT<br>ITEM NO. | ITEM OF WORK AND DESCRIPTION OF<br>WORK OR SERVICES TO BE SUBCONTRACTED<br>OR MATERIALS TO BE PROVIDED * | CERTIFICATION<br>FILE NUMBER | NAME OF DBE | DOLLAR<br>AMOUNT<br>DBE *** | PERCENT<br>DBE |
|----------------------|--|------------------------------|-------------|-----------------------------|----------------|
|----------------------|--|------------------------------|-------------|-----------------------------|----------------|

TOTAL CLAIMED DBE  
 PARTICIPATION \$ \_\_\_\_\_ %

\_\_\_\_\_  
 SIGNATURE OF CONTRACTOR

\_\_\_\_\_  
 DATE

\_\_\_\_\_  
 AREA CODE/TELEPHONE

(Detach from proposal if DBE information is not submitted with proposal.)

- \* If 100% of item is not to be performed or furnished by DBE, describe exact portion, including plan location of work to be performed, of item to be performed or furnished by DBE.
- \*\* DBE's must be certified on the date proposals are opened.
- \*\*\* Credit for a DBE supplier who is not a manufacturer is limited to 60% of the amount paid to the supplier.

**NOTE:** Disadvantaged business must renew their certification annually by submitting certification questionnaires in advance of expiration of current certification. Those not on a current list cannot be considered as certified.

# CONTRACTOR DBE INFORMATION

| CONTRACT<br>ITEM NO. | ITEM OF WORK AND DESCRIPTION OF<br>WORK OR SERVICES TO BE SUBCONTRACTED<br>OR MATERIALS TO BE PROVIDED * | CERTIFICATION<br>FILE NUMBER | NAME OF DBE | DOLLAR<br>AMOUNT<br>DBE *** | PERCENT<br>DBE |
|----------------------|--|------------------------------|-------------|-----------------------------|----------------|
|----------------------|--|------------------------------|-------------|-----------------------------|----------------|

---

---

TOTAL CLAIMED DBE  
PARTICIPATION      \$ \_\_\_\_\_      \_\_\_\_\_ %

---

---

## **PART III**

### **SPECIFICATIONS FOR GOODWILL LOSS APPRAISAL SERVICES**

#### **1. INTRODUCTION**

The Santa Cruz Metropolitan Transit District (District) has adopted a “Resolution of Necessity” in order to initiate eminent domain proceedings to acquire property located at 120 Golf Club Drive, Santa Cruz and has purchased 1122 River Street, Santa Cruz. In order to evaluate potential loss of goodwill claims, District requests proposals from qualified goodwill loss appraisers (Consultant) to perform services as outlined below.

#### **2. SCOPE OF SERVICES**

Consultant will provide the following goodwill loss appraisal services to conform to the specific needs of the District and as mutually agreed to by Consultant and District.

The Consultant will provide preliminary goodwill loss estimates at the acquisition stage, as mutually agreed by Consultant and District. Estimates will include the purpose and function of the assignment, sources of information relied upon, a brief description of the business appraised, and the valuation methodology employed. Preliminary estimates will be presented in a three-to-five page letter. All consultants work shall be in accordance with federal and state requirements and be in accordance with industry standards.

Comprehensive goodwill loss appraisals will be provided for those businesses identified by the District. Comprehensive appraisals will encompass in-depth owner/management interviews, site and area inspections, extensive review and analysis of historical and prospective financial information, industry research, local economic research, and market research to select and employ the valuation methodology appropriate for the business being appraised. A thorough analysis will be conducted on the business owner’s obligation to mitigate the loss of goodwill by relocating or taking other steps to preserve goodwill. The analysis and conclusions will be summarized in a fully contained appraisal report or a statement of valuation suitable for court exchange.

#### **3. BUSINESSES TO BE APPRAISED**

A. Surf City Produce, 120 Golf Club Drive, Santa Cruz

B. Odwalla, 120 Golf Club Drive, Santa Cruz

C. A Tool Shed, 1122 River Street, Santa Cruz

#### **4. FEES AND PAYMENTS**

For goodwill loss appraisal services performed, the District will pay the Consultant on an hourly plus expenses basis.

The hourly rate includes the actual direct pay of personnel assigned to the project (except for routine secretarial and accounting services) plus payroll taxes, insurance, sick leave, holidays, vacation, and other fringe benefits. The percentage of compensation attributable to salary expenses includes all of Consultant’s indirect overhead costs and fees. For purposes of this contract, Consultant’s salary expenses will be compensated at the rates set forth in the fee schedule provided by the Consultant and in accordance with the terms set forth therein.

Salary payment for personnel time will be made at the rates set forth in the proposed fee schedule for all the time charged for the project. Normal payroll rates are for 40 hours per week. Consultant shall not charge District for personnel overtime salary at rates higher than those set forth in the proposed fee schedule without District’s prior

written authorization. Consultant shall provide standard hourly rates and deposition/court hourly rates for personnel that will be assigned to this project.

Payments shall be made monthly by the District based on itemized invoices from the Consultant, which list actual costs and expenses. Such payments shall be for the invoice amount. Consultant fees shall be payable on monthly statements. The monthly statements shall detail the time worked by each class of employee and the expenses incurred for which billing is made. The monthly statements shall contain the following affidavit signed by a principal of the Consultant's firm:

*"I hereby certify as principal of the firm of \_\_\_\_\_, that the charge of \$\_\_\_\_\_ as summarized above and shown in detail on the attachments is fair and reasonable, is in accordance with the terms of the Contract dated \_\_\_\_\_ and has not been previously paid."*

## **5. PROPOSAL REQUIREMENTS**

### **5.1. Minimum Proposal Requirements**

- 5.1.1 Consultant's Experience and Qualifications - -This section should provide a summary description of the Consultant's overall qualifications for this project and previous experience on similar or related engagements.
- 5.1.2 Understanding of the Scope of Work --This section should include a brief narrative introducing the Consultant's understanding of the work required. The contents of this section are to be determined by the particular respondent, but should demonstrate the understanding of the scope of work.
- 5.1.3 Project Personnel --The prospective Consultant shall describe the qualifications of all professional personnel assigned to this project, if applicable, including a summary of similar work. The selected Consultant shall not substitute members of the project team without prior approval of the District.
- 5.1.4 References --The prospective Consultant shall provide names, addresses and telephone numbers for at least three clients for whom he/she has performed goodwill loss appraisal services similar in nature and complexity to that proposed in this RFP.
- 5.1.5 Sub Consultants --For all Sub Consultants to be used, the prospective Consultant must submit a reference for each Sub Consultant. The District must approve all Sub Consultants, and no work may be subcontracted without prior approval of the District.
- 5.1.6 Conflict of Interest --The prospective Consultant shall disclose any financial, business or other relationship with the District or any of its officers or officials that may have an impact upon the outcome of the work. The prospective Consultant shall also list current clients who may have a financial interest in the outcome of the work.
- 5.1.7 Professional Services Contract --Consultant's proposal shall be based on the requirements set forth in the "Professional Services Contract" included in this RFP (Part V). The final agreement between the District and Consultant shall be in substantially the same form and content as the "Professional Services Contract" included herein.
- 5.1.8 Signature --The proposal shall be signed by an official authorized to bind the offeror and shall contain a statement to the effect that the proposal is a firm offer for a 90-day period.
- 5.1.9 Fee Schedule—Provide the standard hourly rates and deposition/court hourly rates for project personnel.
- 5.1.10 Project Fee Estimate --Provide a total project fee estimate reflecting the estimated cost of your proposed scope of services for each business appraisal. The fee estimate must include estimated personnel hours and the hourly rates for each member of Consultant's proposed team.

### **5.2 Proposal Submittal**

One original unbound proposal and four copies must be received no later than 5:00 p.m., due date to the District's Purchasing Division, 120 Dubois Street, Santa Cruz, CA 95060. Proposals must be clearly marked:

"Proposal to Provide Goodwill Loss Appraisal Services, RFP No. 04-02"

### **5.3 Modifications Or Withdrawal Of Proposals**

Any proposal received prior to the date and time specified above for receipt of proposals may be withdrawn or modified by written request of the offeror. To be considered, however, the modified proposal must be received by the date by the date and time specified above.

All verbal modifications of these conditions or provisions are void and ineffective for proposal evaluation purposes. Only written changes issued by the District's Purchasing Office are authorized and binding.

#### **5.4 Rejection of Proposals**

Failure to meet the requirements for the Request for Proposals will be cause for rejection of the proposal. The District may reject any proposal if it is conditional, incomplete or contains irregularities.

The District may waive an immaterial deviation in the proposal. Waiver of an immaterial deviation shall in no way modify the Request for Proposal's documents or excuse the offeror from full compliance with the contract documents if the offeror is awarded the contract. The District reserves the right to not award the contract, should it determine that the proposals are not in its best interest.

### **6. PROPOSAL EVALUATION CRITERIA AND SELECTION PROCEDURES**

- 6.1 Selection of the successful Consultant will be based on information provided in response to the RFP and a variety of qualifications-related criteria, including information provided by Consultant's clients for whom work of a similar nature has been done, evaluation of proposals according to District-specified criteria, and consideration of any exceptions taken to District's proposed contract terms and conditions.
- 6.2 The District will evaluate the qualifications of those Consultants submitting proposals, and an evaluation committee comprised of District Staff will select the most qualified Consultant.
- 6.3 Proposals submitted by each offeror shall be evaluated separately based on how well each proposal meets the criteria listed below.

| <b>Proposal Evaluation Scoring</b>       | <b>Points Possible</b> |
|--|------------------------|
| Consultant's Qualifications & Experience | 50                     |
| References                               | 25                     |
| Project Cost Estimate                    | 20                     |
| DBE Involvement                          | 5                      |
| Total Possible Points                    | 100                    |

### **7. INQUIRIES AND CORRESPONDENCE**

Questions pertaining to this Request for Proposals shall be directed to the District Buyer, Lloyd Longnecker, by email address: [llongnec@scmted.com](mailto:llongnec@scmted.com) or by writing to the District Purchasing Office, 120 Dubois Street, Santa Cruz, CA 95060. No offeror may consider any verbal instructions, interpretations, or changes as an official expression on the District's behalf. Only written addenda signed by the District Buyer may be considered valid.



## **PART IV**

### **GENERAL CONDITIONS TO THE CONTRACT**

#### **I. GENERAL PROVISIONS**

##### **1.01 Governing Law & Compliance with All Laws**

This Contract is governed by and construed in accordance with the laws of California. Each party will perform its obligations hereunder in accordance with all applicable laws, rules, and regulations now or hereafter in effect. Contractor shall ensure throughout the terms of this Agreement that all federal, state and local laws and requirements are met including any requirements District is obligated to perform because of receipt of grant funding. Contractor shall also be required to fulfill its obligation as a federal and/or state and/or local sub-recipient of grant funding.

##### **1.02 Right to Modify Contract**

District may extend the term of this Contract, expand the Scope of Work, or otherwise amend the Contract. Any such extension, expansion or amendment shall be effective only upon written agreement of the parties in accordance with Section 13.14.

#### **2. TERMINATION**

##### **2.01 Termination for Convenience**

2.01.01 The performance of Work under this Contract may be terminated by the District upon fifteen (15) days' notice at any time without cause for any reason in whole or in part, whenever the District determines that such termination is in the District's best interest.

2.01.02 Upon receipt of a notice of termination, and except as otherwise directed by the District, the Contractor shall: (1) stop work under the Contract on the date and to the extent specified in the notice of termination; (2) place no further orders or subcontracts for materials, services, or facilities, except as may be necessary for completion of such portion of the Work under the Contract as is not terminated; (3) terminate all orders and subcontracts to the extent that they relate to the performance of work terminated by the notice of termination; (4) assign to the District in the manner, at the time, and to the extent directed by the District all of the rights, title, and interest of the Contractor under the orders and subcontracts so terminated, in which case the District shall have the right, at its discretion, to settle or pay any or all claims arising out of the termination of such orders and subcontracts; (5) settle all outstanding liabilities and claims arising out of such termination or orders and subcontracts, with the approval or ratification of the District, to the extent the District may require, which approval or ratification shall be final for all the purposes of this clause; (6) transfer title to the District and deliver in the manner, at the time, and to the extent, if any, directed by District the fabricated or unfabricated parts, work in progress, completed work, supplies and other material produced as a part of, or acquired in connection with the performance of, the work terminated and the completed or partially completed plans, drawings, information and other property which, if the Contract had been completed, would have been required to be furnished to the District; (7) use its best efforts to sell, in the manner, at the time, to the extent, and at the price(s) directed or authorized by the District, any property of the types referred to above provided, however, that the Contract shall not be required to extend credit to any purchaser, and may acquire any such property under the conditions prescribed by and at a price(s) approved by the District, and provided further, that the proceeds of any such transfer or disposition shall be applied in reduction of any payments to be made to the District to the Contractor under this Contract or shall otherwise be credited to the price or cost of the Work covered by this Contract or paid in such other manner as the District may direct; (8) complete performance of

such part of the Work as shall not have been terminated by the notice of termination; and (9) take such action as may be necessary, or as the District may direct, for the protection or preservation of the property related to this Contract which is in the possession of the Contractor and in which the District has or may acquire an interest.

## 2.02 Termination for Default

2.02.01 The District may, upon written notice of default to the Contractor, terminate the whole or any part of this Contract if the Contractor: (1) fails to complete the Scope of Work within time period stated in the Specifications section of the IFB; (2) fails to perform any of the other provisions of the Contract; or (3) fails to make progress as to endanger performance of this Contract in accordance with its provisions.

2.02.02 If the Contract is terminated in whole or in part for default, the District may procure, upon such terms and in such manner as the District may deem appropriate, supplies or services similar to those so terminated. Without limitation to any other remedy available to the District, the Contractor shall be liable to the District for any excess costs for such similar supplies or services, and shall continue the performance of this Contract to the extent not terminated under the provisions of this clause.

2.02.03 If, after notice of termination of this Contract under the provisions of this clause, it is determined for any reason that the Contractor was not in default under the provisions of this clause, or that the default was excusable under the provisions of this clause, the rights and obligations of Contractor and District shall be considered to have been terminated pursuant to termination for convenience of the District pursuant to Article 2.01 from the date of Notification of Default.

## 2.03 No Limitation

The rights and remedies of the District provided in this Article 2 shall not be exclusive and are in addition to any other rights and remedies provided by law or under this Contract.

## 3. FORCE MAJEURE

### 3.01 General

Neither party hereto shall be deemed to be in default of any provision of this Contract, or for any failure in performance, resulting from acts or events beyond the reasonable control of such party. For purposes of this Contract, such acts shall include, but not be limited to, acts of God, civil or military authority, civil disturbance, war, strikes, fires, other catastrophes, or other "force majeure" events beyond the parties' reasonable control; provided, however, that the provisions of this Section 3 shall not preclude District from canceling or terminating this Contract (or any order for any product included herein), as otherwise permitted hereunder, regardless of any force majeure event occurring to Contractor.

### 3.02 Notification by Contractor

Contractor shall notify District in writing as soon as Contractor knows, or should reasonably know, that a force majeure event (as defined in Section 3.01) has occurred that will delay completion of the Scope of Work. Said notification shall include reasonable proofs required by the District to evaluate any Contractor request for relief under this Article 3. District shall examine Contractor's notification and determine if the Contractor is entitled to relief. The District shall notify the Contractor of its decision in writing. The District's decision regarding whether or not the Contractor is entitled to force majeure relief shall be final and binding on the parties.

### 3.03 Losses

Contractor is not entitled to damages, compensation, or reimbursement from the District for losses resulting from any "force majeure" event.

## 4. PROFESSIONAL STANDARDS

Contractor shall at all times during the term of this Contract possess the technical ability, experience, financial ability, overall expertise, and all other skills, licenses, and resources necessary to perform and complete the scope of work in a timely, professional manner so as to meet or exceed the provisions of this Contract.

## 5. PROFESSIONAL RELATIONS

### 5.01 Independent Contractor

No relationship of employer and employee is created by this Contract. In the performance of its work and duties, Contractor is at all times acting and performing as an independent contractor in the practice of its profession. District shall neither have nor exercise control or direction over the methods by which Contractor performs services pursuant to this Contract (including, without limitation, its officers, shareholders, and employees); provided, however, that Contractor agrees that all work performed pursuant to this Contract shall be in strict accordance with currently approved methods and practices in its profession, and in accordance with this Contract. The sole interest of District is to ensure that such services are performed and rendered in a competent and cost effective manner.

### 5.02 Benefits

Contractor (including, without limitation, its officers, shareholders, subcontractors and employees) has no claim under this Contract or otherwise against the District for social security benefits, workers' compensation benefits, disability benefits, unemployment benefits, vacation pay, sick leave, or any other employee benefit of any kind.

## 6. INDEMNIFICATION FOR DAMAGES, TAXES AND CONTRIBUTIONS

### 6.01 Scope

Contractor shall exonerate, indemnify, defend, and hold harmless District (which for the purpose of Articles 6 and 7 shall include, without limitation, its officers, agents, employees and volunteers) from and against:

6.01.01 Any and all claims, demands, losses, damages, defense costs, or liability of any kind or nature which District may sustain or incur or which may be imposed upon it for injury to or death of persons, or damage to property as a result of, or arising out of, or in any manner connected with the Contractor's performance under the provisions of this Contract. Such indemnification includes any damage to the person(s) or property (ies) of Contractor and third persons.

6.01.02 Any and all Federal, state and local taxes, charges, fees, or contributions required to be paid with respect to Contractor, Contractor's officers, employees and agents engaged in the performance of this Contract (including, without limitation, unemployment insurance, social security, and payroll tax withholding).

## 7. INSURANCE

### 7.01 General

Contractor, at its sole cost and expense, for the full term of this Contract (and any extensions thereof), shall obtain and maintain at minimum all of the following insurance coverage. Such insurance coverage shall be

primary coverage as respects District and any insurance or self-insurance maintained by District shall be excess of Contractor's insurance coverage and shall not contribute to it.

#### 7.02 Types of Insurance and Minimum Limits

Contractor shall obtain and maintain during the term of this Contract:

- (1) Worker's Compensation and Employer's Liability Insurance in conformance with the laws of the State of California (not required for Contractor's subcontractors having no employees).
- (2) Contractor's vehicles used in the performance of this Contract, including owned, non-owned (e.g. owned by Contractor's employees), leased or hired vehicles, shall each be covered with Automobile Liability Insurance in the minimum amount of \$1,000,000.00 combined single limit per accident for bodily injury and property damage.
- (3) Contractor shall obtain and maintain Comprehensive General Liability Insurance coverage in the minimum amount of \$1,000,000.00 combined single limit, including bodily injury, personal injury, and property damage. Such insurance coverage shall include, without limitation:
  - (a) Contractual liability coverage adequate to meet the Contractor's indemnification obligations under this contract.
  - (a) Full Personal Injury coverage.
  - (a) Broad form Property Damage coverage.
  - (a) A cross-liability clause in favor of the District.
- (4) Contractor shall obtain and maintain Professional Liability Insurance coverage in the minimum amount of \$1,000,000.00.

#### 7.03 Other Insurance Provisions

- (1) As to all insurance coverage required herein, any deductible or self-insured retention exceeding \$5,000.00 shall be disclosed to and be subject to written approval by District.
- (2) If any insurance coverage required hereunder is provided on a "claims made" rather than "occurrence" form, Contractor shall maintain such insurance coverage for three (3) years after expiration of the term (and any extensions) of this Contract.
- (3) All required Automobile Liability Insurance and Comprehensive or Commercial General Liability Insurance shall contain the following endorsement as a part of each policy: "The Santa Cruz Metropolitan Transit District is hereby added as an additional insured as respects the operations of the named insured."
- (4) All the insurance required herein shall contain the following clause: "It is agreed that this insurance shall not be canceled until thirty (30) days after the District shall have been given written notice of such cancellation or reduction."
- (5) Contractor shall notify District in writing at least thirty (30) days in advance of any reduction in any insurance policy required under this Contract.
- (6) Contractor agrees to provide District at or before the effective date of this Contract with a certificate of insurance of the coverage required.
- (1) All insurance shall be obtained from brokers or carriers authorized to transact business in California and are satisfactory to the District.

## 8. RESERVED

## 9. NO DISCRIMINATION

In connection with the performance of services provided under this Contract, Contractor shall not on the grounds of race, color, creed, ancestry, national origin, religion, sex, sexual orientation, marital status, age, medical condition or disability discriminate or permit discrimination against any person or group of persons in any manner prohibited by Federal, State, or local laws.

## 10. DISADVANTAGED BUSINESS ENTERPRISES

The Board of Directors of the Santa Cruz Metropolitan Transit District has adopted a Disadvantaged Business Enterprise Policy to promote the participation of disadvantaged business enterprises (DBE's) in all areas of District contracting to the maximum extent practicable. Consistent with the DBE Policy, the Contractor shall take all necessary and reasonable steps to ensure that DBE firms have the maximum practicable opportunity to participate in the performance of this project and any subcontracting opportunities thereof.

## 11. PROMPT PAYMENT

The prime contractor agrees to pay each subcontractor under this prime contract for satisfactory performance of its contract no later than 30 days from the receipt of each payment the prime contractor receives from District. The prime contractor agrees further to return retainage payments to each subcontractor within 30 days after the subcontractor's work is satisfactorily completed. Any delay or postponement of payment from the above referenced time frame may occur only for good cause following written approval of the District. This applies to both DBE and non-DBE subcontractors.

Prime subcontractors must include the prompt payment language of paragraph 1 in all subcontracts, regardless of subcontractor's DBE status. Failure of a prime contractor to uphold prompt payment requirements for subcontractors will result in District withholding reimbursement for completed work.

## 12. RESERVED

## 13. MISCELLANEOUS PROVISIONS

### 13.01 Successors and Assigns

The Contract shall inure to the benefit of, and be binding upon, the respective successors and assigns, if any, of the parties hereto, except that nothing contained in this Article shall be construed to permit any attempted assignment which would be unauthorized or void pursuant to any other provision of this Contract.

### 13.02 Survival of Rights and Obligations

In the event of termination, the rights and obligations of the parties which by their nature survive termination of the services covered by this Contract shall remain in full force and effect after termination. Compensation and revenues due from one party to the other under this Contract shall be paid; loaned equipment and material shall be returned to their respective owners; the duty to maintain and allow inspection of books, accounts, records and data shall be extended as provided in Section 13.15; and the hold harmless agreement contained in Article 6 shall survive.

### 13.03 Limitation on District Liability

The District's liability is, in the aggregate, limited to the total amount payable under this Contract.

13.04 Drug and Alcohol Policy

Contractor shall not use, possess, manufacture, or distribute alcohol or illegal drugs during the performance of the Contract or while on District premises or distribute same to District employees.

13.05 Publicity

Contractor agrees to submit to District all advertising, sales promotion, and other public matter relating to any service furnished by Contractor wherein the District's name is mentioned or language used from which the connection of District's name therewith may, within reason, be inferred or implied. Contractor further agrees not to publish or use any such advertising, sales promotion or publicity matter without the prior written consent of District.

13.06 Consent to Breach Not Waiver

No provision hereof shall be deemed waived and no breach excused, unless such waiver or consent shall be in writing and signed by the party claimed to have waived or consented. Any consent by any party to, or waiver of, a breach by the other, whether express or implied, shall not constitute a consent to, waiver of, or excuse for any other different or subsequent breach.

13.07 Attorneys' Fees

In the event that suit is brought to enforce or interpret any part of this Contract, the prevailing party shall be entitled to recover as an element of its costs of suit, and not as damages, a reasonable attorney's fee to be fixed by the court. The "prevailing party" shall be the party who is entitled to recover its costs of suit, whether or not the suit proceeds to final judgment. A party not entitled to recover its costs shall not recover attorney's fees. No sum for attorney's fees shall be counted in calculating the amount of a judgment for purposes of determining whether a party is entitled to recover its costs or attorney's fees.

13.08 No Conflict of Interest

Contractor represents that it currently has no interest, and shall not have any interest, direct or indirect, that would conflict in any manner with the performance of services required under this Contract.

13.09 Prohibition of Discrimination against Qualified Handicapped Persons

Contractor shall comply with the provisions of Section 504 of the Rehabilitation Act of 1973, as amended, pertaining to the prohibition of discrimination against qualified handicapped persons in federally-assisted programs.

13.10 Cal OSHA/Hazardous Substances

13.10.01 Contractor shall comply with California Administrative Code Title 8, Section 5194, and shall directly (1) inform its employees of the hazardous substances they may be exposed to while performing their work on District property, (2) ensure that its employees take appropriate protective measures, and (3) provide the District's Manager of Facility Maintenance with a Material Safety Data Sheet (MSDS) for all hazardous substances to be used on District property.

13.10.02 Contractor shall comply with Cal OSHA regulations and the Hazardous Substance Training and Information Act. Further, said parties shall indemnify the District against any and all damage, loss, and injury resulting from non-compliance with this Article.

13.10.03 Contractor will comply with the Safe Drinking Water and Toxic Enforcement Act of 1986 (Proposition 65) California Health and Safety Code Section 25249.5 - 25249.13. Contractor will ensure that clear and reasonable warnings are made to persons exposed to those chemicals listed by the State of California as being known to cause cancer or reproductive toxicity.

13.10.04 Contractor shall be solely responsible for any hazardous material, substance or chemical released or threatened release caused or contributed to by Contractor. Contractor shall be solely responsible for all clean-up efforts and costs.

13.11 Non-Assignment of Contract

The Contractor shall not assign, transfer, convey, sublet, or otherwise dispose of the Contract or Contractor's right, title or interest in or to the same or any part thereof without previous written consent by the District; and any such action by Contractor without District's previous written consent shall be void.

13.12 No Subcontract

Contractor shall not subcontract or permit anyone other than Contractor or its authorized staff and subcontractors to perform any of the scope of work, services or other performance required of Contractor under this Contract without the prior written consent of the District. Any such action by Contractor without District's previous consent shall be void.

13.13 Severability

If any provision of this Contract is held by a court of competent jurisdiction to be invalid, void or unenforceable, the remaining provisions shall continue in full force and effect, and shall in no way be affected, impaired or invalidated.

13.14 All Amendments in Writing

No amendment to this Contract shall be effective unless it is in writing and signed by duly authorized representatives of both parties.

13.15 Audit

This Contract is subject to audit by Federal, State, or District personnel or their representatives at no cost for a period of four (4) years after the date of expiration or termination of the Contract. Requests for audits shall be made in writing, and Contractor shall respond with all information requested within ten (10) calendar days of the date of the request. During the four-year period that the Contract is subject to audit, Contractor shall maintain detailed records substantiating all costs and expenses billed against the Contract.

13.16 Smoking Prohibited

Contractor, its employees and agents shall not smoke in any enclosed area on District premises or in a District vehicle.

13.17 Responsibility for Equipment

13.17.01 District shall not be responsible nor held liable for any damage to person or property consequent upon the use, or misuse, or failure of any equipment used by Contractor, or any of its employees, even though such equipment be furnished, rented or loaned to Contractor by District.

13.17.02 Contractor is responsible to return to the District in good condition any equipment, including keys, issued to it by the District pursuant to this Agreement. If the contractor fails or refuses to return District-issued equipment within five days of the conclusion of the contract work the District shall deduct the actual costs to repair or replace the equipment not returned from the final payment owed to contractor or take other appropriate legal action at the discretion of the District.

13.18 Grant Contracts

13.18.01 Contractor shall ensure throughout the terms of this Agreement that all federal, state and local laws and requirements are met including any requirements District is obligated to perform because of receipt of grant funding. Contractor shall also be required to fulfill its obligation as a federal and/or state and/or local sub-recipient of grant funding.

13.19 Time of the Essence

13.19.01 Time is of the essence in this Contract



## PART V

### PROFESSIONAL SERVICES CONTRACT FOR GOODWILL LOSS APPRAISAL SERVICES (04-02)

THIS CONTRACT is made effective on \_\_\_\_\_, 2004 between the SANTA CRUZ METROPOLITAN TRANSIT DISTRICT, a political subdivision of the State of California ("District"), and \_\_\_\_\_ ("Contractor").

#### 1. RECITALS

##### 1.01 District's Primary Objective

District is a public entity whose primary objective is providing public transportation and has its principal office at 370 Encinal Street, Suite 100, Santa Cruz, California 95060.

##### 1.02 District's Need for Goodwill Loss Appraisal Services

District has the need for Goodwill Loss Appraisal Services. In order to obtain these services, the District issued a Request for Proposals, dated July 22, 2004, setting forth specifications for such services. The Request for Proposals is attached hereto and incorporated herein by reference as Exhibit "A".

##### 1.03 Contractor's Proposal

Contractor is a firm/individual qualified to provide Goodwill Loss Appraisal Services and whose principal place of business is \_\_\_\_\_. Pursuant to the Request for Proposals by the District, Contractor submitted a proposal for Goodwill Loss Appraisal Services, which is attached hereto and incorporated herein by reference as Exhibit "B."

##### 1.04 Selection of Contractor and Intent of Contract

On \_\_\_\_\_, District selected Contractor as the offeror whose proposal was most advantageous to the District, to provide the Goodwill Loss Appraisal Services described herein. This Contract is intended to fix the provisions of these services.

District and Contractor agree as follows:

#### 2. INCORPORATED DOCUMENTS AND APPLICABLE LAW

##### 2.01 Documents Incorporated in this Contract

The documents below are attached to this Contract and by reference made a part hereof. This is an integrated Contract. This writing constitutes the final expression of the parties' contract, and it is a complete and exclusive statement of the provisions of that Contract, except for written amendments, if any, made after the date of this Contract in accordance with Section 13.14.

##### A. Exhibit "A"

Santa Cruz Metropolitan Transit District's "Request for Proposals" dated July 22, 2004

##### B. Exhibit "B" (Contractor's Proposal)

Contractor's Proposal to the District for Goodwill Loss Appraisal Services, signed by Contractor and dated August 12, 2004.

2.02 Conflicts

Where in conflict, the provisions of this writing supersede those of the above-referenced documents, Exhibits "A" and "B". Where in conflict, the provisions of Exhibit "A" supercede Exhibit "B".

2.03 Recitals

The Recitals set forth in Article 1 are part of this Contract.

3. DEFINITIONS

3.01 General

The terms below (or pronouns in place of them) have the following meaning in the contract:

3.01.01 CONTRACT - The Contract consists of this document, the attachments incorporated herein in accordance with Article 2, and any written amendments made in accordance with Section 13.14.

3.01.02 CONTRACTOR - The Contractor selected by District for this project in accordance with the Request for Proposals issued July 22, 2004.

3.01.03 CONTRACTOR'S STAFF - Employees of Contractor.

3.01.04 DAYS - Calendar days.

3.01.05 OFFEROR - Contractor whose proposal was accepted under the terms and conditions of the Request for Proposals issued July 22, 2004.

3.01.06 PROVISION - Any term, agreement, covenant, condition, clause, qualification, restriction, reservation, or other stipulation in the contract that defines or otherwise controls, establishes, or limits the performance required or permitted by either party.

3.01.07 SCOPE OF WORK (OR "WORK") - The entire obligation under the Contract, including, without limitation, all labor, equipment, materials, supplies, transportation, services, and other work products and expenses, express or implied, in the Contract.

4. TIME OF PERFORMANCE

4.01 Term

The term of this Contract will be for a period not to exceed one (1) year or until completion of duties and responsibilities and shall commence upon the issuance of the contract by the District.

At the option of the District, this contract agreement may be renewed for four (4) additional one (1) year terms upon mutual written consent.

5. COMPENSATION

5.01 Terms of Payment

District shall compensate Contractor in an amount not to exceed the amounts/rates agreed upon by the District. District shall reasonably determine whether work has been successfully performed for purposes of

payment. Compensation shall be made within forty-five (45) days of District written approval of Contractor's written invoice for said work. Contractor understands and agrees that if he/she exceeds the \$\_\_\_\_\_ maximum amount payable under this contract, that it does so at its own risk.

5.02 Invoices

Contractor shall submit invoices with a project number provided by the District on a monthly basis. Contractor's invoices shall include detailed records showing actual time devoted, work accomplished, date work accomplished, personnel used, and amount billed per hour. Expenses shall only be billed if allowed under the Contract. Telephone call expenses shall show the nature of the call and identify location and individual called. Said invoice records shall be kept up-to-date at all times and shall be available for inspection by the District (or any grantor of the District, including, without limitation, any State or Federal agency providing project funding or reimbursement) at any time for any reason upon demand for not less than four (4) years after the date of expiration or termination of the Contract. Under penalty of law, Contractor represents that all amounts billed to the District are (1) actually incurred; (2) reasonable in amount; (3) related to this Contract; and (4) necessary for performance of the project.

6. NOTICES

All notices under this Contract shall be deemed duly given upon delivery, if delivered by hand; or three (3) days after posting, if sent by registered mail, receipt requested; to a party hereto at the address hereinunder set forth or to such other address as a party may designate by notice pursuant hereto.

DISTRICT

Santa Cruz Metropolitan Transit District  
370 Encinal Street  
Suite 100  
Santa Cruz, CA 95060  
Attention: General Manager

CONTRACTOR

\_\_\_\_\_  
\_\_\_\_\_  
\_\_\_\_\_  
Attention: \_\_\_\_\_

7. AUTHORITY

Each party has full power and authority to enter into and perform this Contract and the person signing this Contract on behalf of each has been properly authorized and empowered to enter into this Contract. Each party further acknowledges that it has read this Contract, understands it, and agrees to be bound by it.

Signed on \_\_\_\_\_

DISTRICT  
SANTA CRUZ METROPOLITAN TRANSIT DISTRICT

\_\_\_\_\_  
Leslie R. White  
General Manager

CONTRACTOR

By \_\_\_\_\_

Approved as to Form:

\_\_\_\_\_  
Margaret Rose Gallagher  
District Counsel

## **PART VI**

### **FEDERAL TRANSIT ADMINISTRATION REQUIREMENTS FOR NON-CONSTRUCTION CONTRACTS**

#### **1.0 GENERAL**

This Contract is subject to the terms of a financial assistance contract between the Santa Cruz Metropolitan Transit District and the Federal Transit Administration (FTA) of the United States Department of Transportation.

#### **2.0 INTEREST TO MEMBERS OF OR DELEGATES TO CONGRESS**

In accordance with 18 U.S.C. 431, no member of, nor delegates to, the Congress of the United States shall be admitted to a share or part of this Contract or to any benefit arising therefrom.

#### **3.0 INELIGIBLE CONTRACTORS**

Neither Contractor, subcontractor, nor any officer or controlling interest holder of Contractor or subcontractor, is currently, or has been previously, on any debarred bidders list maintained by the United States Government.

#### **4.0 EQUAL EMPLOYMENT OPPORTUNITY (Not applicable to contracts for standard commercial supplies and raw materials)**

In connection with the execution of this Contract, the Contractor shall not discriminate against any employee or application for employment because of race, religion, color, sex, age (40 or over), national origin, pregnancy, ancestry, marital status, medical condition, physical handicap, sexual orientation, or citizenship status. The Contractor shall take affirmative action to insure that applicants employed and that employees are treated during their employment, without regard to their race, religion, color, sex national origin, etc. Such actions shall include, but not be limited to the following: Employment, upgrading, demotion or transfer; recruitment or recruitment advertising; layoff or termination; rates of pay or other forms of compensation; and, selection for training including apprenticeship. Contractor further agrees to insert a similar provision in all subcontracts, except subcontracts for standard commercial supplies or raw materials.

#### **5.0 TITLE VI CIVIL RIGHTS ACT OF 1964**

During the performance of this Contract, the Contractor, for itself, its assignees and successors in interest (hereinafter referred to as the "Contractor"), agrees as follows:

##### **5.1 Compliance with Regulations**

The Contractor shall comply with the Regulations relative to nondiscrimination in federally assisted programs of the Department of Transportation (hereinafter "DOT") Title 49, Code of Federal Regulations, Part 21, as they may be amended from time to time (hereinafter referred to as the "Regulations"), which are herein incorporated by reference and made a part of this Contract.

##### **5.2 Nondiscrimination**

The Contractor, with regard to the work performed by it during the Contract, shall not discriminate on the grounds of race, religion, color, sex, age or national origin in the selection and retention of subcontractors, including procurements of materials and leases of equipment. The Contractor shall not participate either directly or indirectly in the discrimination prohibited in Section 21.5 of the Regulations, including employment practices when the Contract covers a program set forth in Appendix B of the regulations.

### 5.3 Solicitations for Subcontracts, Including Procurements of Materials and Equipment

In all solicitations either by competitive bidding or negotiation made by the Contractor for work to be performed under a subcontract, including procurements of materials or leases of equipment, each potential subcontractor or supplier shall be notified by the Contractor of the Contractor's obligations under this Contract and the Regulations relative to nondiscrimination on the grounds of race, religion, color, sex, age or national origin.

### 5.4 Information and Reports

The Contractor shall provide all information and reports required by the Regulations or directives issued pursuant thereto, and shall permit access to its books, records, accounts, other sources of information, and its facilities as may be determined by the District or the Federal Transit Administration (FTA) to be pertinent to ascertain compliance with such Regulations, orders and instructions. Where any information is required or a Contractor is in the exclusive possession of another who fails or refuses to furnish this information, the Contractor shall so certify to the District, or the Federal Transit Administration, as appropriate, and shall set forth what efforts it has made to obtain the information.

### 5.5 Sanctions for Noncompliance

In the event of the Contractor's noncompliance with the nondiscrimination provisions of this Contract, the District shall impose such contract sanctions as it or the Federal Transit Administration may determine to be appropriate, including, but not limited to:

- (a) Withholding of payments to the Contractor under the Contract until the Contractor complies; and/or,
- (b) Cancellation, termination or suspension of the Contract, in whole or in part.

### 5.6 Incorporation of Provisions

The Contractor shall include the provisions of Paragraphs (1) through (6) of this section in every subcontract, including procurements of materials and leases of equipment, unless exempt by the Regulations or directives issued pursuant thereto. The Contractor shall take such action with respect to any subcontract or procurement as the District or the Federal Transit Administration may direct as a means of enforcing such provisions, including sanctions for noncompliance; provided, however, that in the event a Contractor becomes involved in, or is threatened with, litigation with a subcontractor or supplier as a result of such direction, the Contractor may require the District to enter into such litigation to protect the interests of the District, and, in addition, the Contractor may request the services of the Attorney General in such litigation to protect the interests of the United States.

### 6.0 CLEAN AIR AND FEDERAL WATER POLLUTION CONTROL ACTS (Applicable only to contracts in excess of \$100,000)

Contractor shall comply with all applicable standards, orders or requirements issued under Section 306 of the Clean Air Act (42 USC 1857[h]), Section 508 of the Clean Water Act (33 USC 1368), Executive Order 11738, and Environmental Protection Agency Regulations (40 CFR, Part 15), which prohibit the use under non-exempt Federal contracts, grants or loans of facilities included on the EPA List of Violating Facilities. Contractor shall report all violations to FTA and to the USEPA Assistant Administrator for Enforcement (EN0329).

### 7.0 CONSERVATION

Contractor shall recognize mandatory standards and policies relating to energy efficiency which are contained in the State energy conservation plan issued in compliance with the Energy Policy and Conservation Act (42 USC Section 6321, et seq.).

8.0 AUDIT AND INSPECTION OF RECORDS (Applicable only to sole source or negotiated contracts in excess of \$10,000)

Contractor agrees that the District, the Comptroller General of the United States, or any of their duly authorized representatives shall, for the purpose of audit and examination, be permitted to inspect all work, materials, payrolls and other data and records with regard to the project, and to audit the books, records and accounts with regard to the project. Further, Contractor agrees to maintain all required records for at least three years after District makes final payments and all other pending matters are closed.

9.0 LABOR PROVISIONS (Applicable only to contracts of \$2,500.00 or more that involve the employment of mechanics or laborers)

9.1 Overtime Requirements

No Contractor or subcontractor contracting for any part of the contract work which may require or involve the employment of laborers or mechanics shall require or permit any such laborer or mechanic in any work week in which he or she is employed on such work to work in excess of eight (8) hours in any calendar day or in excess of forty (40) hours in such work week unless such laborer or mechanic receives compensation at a rate not less than one and one-half (1 1/2) times the basic rate of pay for all hours worked in excess of eight (8) hours in any calendar day or in excess of forty (40) hours in such work week, whichever is greater.

9.2 Violation; Liability for Unpaid Wages; Liquidated Damages

In the event of any violation of the clause set forth in subparagraph (b)(1) of 29 CFR Section 5.5, the Contractor and any subcontractor responsible therefore shall be liable for the unpaid wages. In addition, such Contractor and subcontractor shall be liable to the United States (in the case of work done under contract for the District of Columbia or a territory, to such district or to such territory), for liquidated damages. Such liquidated damages shall be computed with respect to each individual laborer or mechanic, including watchmen and guards, employed in violation of the clause set forth in subparagraph (b)(1) of which such individual was required or permitted to work in excess of eight (8) hours in excess of the standard work week of forty (40) hours without payment of the overtime wages required by the clause set forth in subparagraph (b)(1) of 29 CFR Section 5.5.

9.3 Withholding for Unpaid Wages and Liquidated Damages

DOT or the District shall upon its own action or upon written request of an authorized representative of the Department of Labor withhold or cause to be withheld, from any monies payable on account of work performed by the Contractor or subcontractor under any such contract or any other Federal contract with the same prime Contractor, or any other federally-assisted contract subject to the Contract Work Hours and Safety Standards Act, which is held by the same prime Contractor, such sums as may be determined to be necessary to satisfy any liabilities of such Contractor or subcontractor for unpaid wages and liquidated damages as provided in the clause set forth in subparagraph (b)(2) of 29 CFR Section 5.5.

9.4 Nonconstruction Grants

The Contractor or subcontractor shall maintain payrolls and basic payroll records during the course of the work and shall preserve them for a period of three (3) years from the completion of the Contract for all laborers and mechanics, including guards and watchmen, working on the Contract. Such records shall contain the name and address of each such employee, social security

number, correct classifications, hourly rates of wages paid, daily and weekly number of hours worked, deductions made and actual wages paid. Further, the District shall require the contracting officer to insert in any such contract a clause providing that the records to be maintained under this paragraph shall be made available by the Contractor or subcontractor for inspection, copying or transcription by authorized representatives of DOT and the Department of Labor, and the Contractor or subcontractor will permit such representatives to interview employees during working hours on the job.

#### 9.5 Subcontracts

The Contractor or subcontractor shall insert in any subcontracts the clauses set forth in subparagraph (1) through (5) of this paragraph and also a clause requiring the subcontractors to include these clauses in any lower tier subcontracts. The prime contractor shall be responsible for compliance by any subcontractor or lower tier subcontractor with the clauses set forth in subparagraphs (1) through (5) of this paragraph.

#### 10.0 CARGO PREFERENCE (Applicable only to Contracts under which equipment, materials or commodities may be transported by ocean vehicle in carrying out the project)

The Contractor agrees:

- 10.1 To utilize privately owned United States-flag commercial vessels to ship at least fifty percent (50%) of the gross tonnage (computed separately for dry bulk carriers, dry cargo liners and tankers) involved, whenever shipping any equipment, materials or commodities pursuant to this section, to the extent such vessels are available at fair and reasonable rates for United States- flag commercial vessels.
- 10.2 To furnish within 30 days following the date of loading for shipments originating within the United States, or within thirty (30) working days following the date of loading for shipment originating outside the United States, a legible copy of a rated, "on-board" commercial ocean bill-of-lading in English for each shipment of cargo described in paragraph (1) above, to the District (through the prime Contractor in the case of subcontractor bills-of-lading) and to the Division of National Cargo, Office of Market Development, Maritime Administration, 400 Seventh Street, S.W., Washington D. C. 20590, marked with appropriate identification of the project.
- 10.3 To insert the substance of the provisions of this clause in all subcontracts issued pursuant to this Contract.

#### 11.0 BUY AMERICA PROVISION

This procurement is subject to the Federal Transportation Administration Buy America Requirements in 49 CFR 661. A Buy America Certificate, if required format (see Form of Proposal or Bid Form) must be completed and submitted with the proposal. A proposal that does not include the certificate shall be considered non-responsive. A waiver from the Buy America Provision may be sought by the District if grounds for the waiver exist. Section 165a of the Surface Transportation Act of 1982 permits FTA participation on this Contract only if steel and manufactured products used in the Contract are produced in the United States. In order for rolling stock to qualify as a domestic end product, the cost of components produced in the United States must exceed sixty percent (60%) of the cost of all components, and final assembly must take place in the United States.



## 12.0 DISADVANTAGED BUSINESS ENTERPRISE (DBE) PARTICIPATION

### 12.1 Policy

It is the policy of the U.S. Department of Transportation that Disadvantaged Business Enterprises as defined in 49 CFR Part 23 shall have the maximum opportunity to participate in the performance of contracts financed in whole or in part with Federal funds under this Agreement. Consequently, the DBE requirements of 49 CFR Part 23 apply to this Agreement.

### 12.2 DBE Obligation

District and Contractor agree to insure that Disadvantaged Business Enterprises as defined in 49 CFR Part 23 have the maximum opportunity to participate in the performance of contracts and subcontracts under this Agreement. In this regard, District and Contractor shall take all necessary and reasonable steps in accordance with 49 CFR Part 23 to insure that Disadvantaged Business Enterprises have the maximum opportunity to compete for and perform Contracts. District and Contractor shall not discriminate on the basis of race, creed, color, national origin, age or sex in the award and performance of DOT-assisted Contracts.

### 12.3 Transit Vehicle Manufacturers

Transit vehicle manufacturers must certify compliance with DBE regulations.

## 13.0 CONFLICT OF INTEREST

No employee, officer or agent of the District shall participate in selection, or in the award of administration of a contract if a conflict of interest, real or apparent, would be involved. Such a conflict would arise when (1) the employee, officer or agent; (2) any member of his or her immediate family; (3) his or her partner; or (4) an organization that employs, or is about to employ, has a financial or other interest in the firm selected for award. The District's officers, employees or agents shall neither solicit nor accept gratuities, favors or anything of monetary value from Contractors, potential Contractors or parties of sub agreements.

## 14.0 MOTOR VEHICLE EMISSION REQUIREMENTS (Applicable only to Contracts involving the purchase of new motor vehicles)

The Contractor must provide a certification that:

- (a) The horsepower of the vehicle is adequate for the speed, range, and terrain in which it will be required and also to meet the demands of all auxiliary equipment.
- (b) All gases and vapors emanating from the crankcase of a spark-ignition engine are controlled to minimize their escape into the atmosphere.
- (c) Visible emission from the exhaust will not exceed No. 1 on the Ringlemann Scale when measured six inches (6") from the tail pipe with the vehicle in steady operation.
- (d) When the vehicle has been idled for three (3) minutes and then accelerated to eighty percent (80%) of rated speed under load, the opacity of the exhaust will not exceed No. 2 on the Ringlemann Scale for more than five (5) seconds, and not more than No. 1 on the Ringlemann Scale thereafter.

## 15.0 MOTOR VEHICLE SAFETY STANDARDS (Applicable only to contracts involving the purchase of new motor vehicles)

The Contractor will assure that the motor vehicles purchased under this contract will comply with the Motor Vehicle Safety Standards as established by the Department of Transportation at 49 CFR Parts 390 and 571.

## 16.0 DEBARRED BIDDERS

The Contractor, including any of its officers or holders of a controlling interest, is obligated to inform the District whether or not it is or has been on any debarred bidders' list maintained by the United States Government. Should the Contractor be included on such a list during the performance of this project, Contractor shall so inform the District.

## 17.0 PRIVACY (Applicable only to Contracts involving the administration of any system of records as defined by the Privacy Act of 1974, on behalf of the Federal Government)

### 17.1 General

The District and Contractor agree:

- (a) To comply with the Privacy Act of 1974, 5 U.S.C. 552a (the Act) and the rules and regulations issued pursuant to the Act when performance under the Contract involves the design, development or operation of any system of records on individuals to be operated by the District, its contractors or employees to accomplish a Government function.
- (b) To notify the Government when the District or Contractor anticipates operating a system of records on behalf of the Government in order to accomplish the requirements of this Agreement, if such system contains information about individuals which information will be retrieved by the individual's name or other identifier assigned to the individual. A system of records subject to the Act may not be employed in the performance of this Agreement until the necessary approval and publication requirements applicable to the system have been carried out. The District or Contractor, as appropriate, agrees to correct, maintain, disseminate, and use such records in accordance with the requirements of the Act, and to comply with all applicable requirements of the Act.
- (c) To include the Privacy Act Notification contained in this Agreement in every subcontract solicitation and in every subcontract when the performance of Work under the proposed subcontract may involve the design, development or operation of a system of records on individuals that is to be operated under the Contract to accomplish a Government function; and
- (d) To include this clause, including this paragraph in all in subcontracts under which Work for this Agreement is performed or which is awarded pursuant to this Agreement or which may involve the design, development, or operation of such a system of records on behalf of the Government.

### 17.2 Applicability

For purposes of the Privacy Act, when the Agreement involves the operation of a system of records on individuals to accomplish a Government function, the District, third party contractors and any of their employees are considered to be employees of the Government with respect to the Government function and the requirements of the Act, including the civil and criminal penalties for violations of the Act, are applicable except that the criminal penalties shall not apply with regard to contracts effective prior to September 27, 1975. In addition, failure to comply with the provisions of the Act or of this clause will make this Agreement subject to termination.

### 17.3 Definitions

The terms used in this clause have the following meanings:

- (a) "Operation of a system of records" means performance of any of the activities associated with maintaining the system of records on behalf of the Government including the collection, use and dissemination of records.
- (b) "Records" means any item, collection or grouping of information about an individual that is maintained by the District or Contractor on behalf of the Government, including, but not limited to, his education, financial transactions, medical history, and criminal or employment history and that contains his name, or the identifying number, symbol or other identifying particular assigned to the individual, such as a finger or voice print or a photograph.
- (c) "System of records" on individuals means a group of any records under the control of the District or Contractor on behalf of the Government from which information is retrieved by the name of the individual or by some identifying number, symbol or other identifying particular assigned to the individual.

18.0 PATENT RIGHTS (Applicable only to research and development contracts)

If any invention, improvement or discovery of the District or contractors or subcontractors is conceived or first actually reduced to practice in the course of or under this project which invention, improvement, or discovery may be patentable under the Patent Laws of the United States of America or any foreign country, the District (with appropriate assistance of any contractor or subcontractor involved) shall immediately notify the Government (FTA) and provide a detailed report. The rights and responsibilities of the District, third party contractors and subcontractors and the Government with respect to such invention will be determined in accordance with applicable Federal laws, regulations, policies and any waivers thereof.

19.0 RIGHTS IN DATA (Applicable only to research and development contracts)

The term "subject data" as used herein means recorded information, whether or not copyrighted, that is delivered or specified to be delivered under this Contract. The term includes graphic or pictorial delineation in media such as drawings or photographs; text in specifications or related performance or design-type documents, machine forms such as punched cards, magnetic tape or computer memory printouts; and information retained in computer memory. Examples include, but are not limited to, engineering drawings and associated lists, specifications, standards, process sheets, manuals, technical reports, catalog item identifications and related information. The term does not include financial reports, cost analyses and similar information incidental to contract administration.

All "subject data" first produced in the performance of this Agreement shall be the sole property of the Government. The District and Contractor agree not to assert any rights at common law or equity and not to establish any claim to statutory copyright in such data. Except for its own internal use, the District and Contractor shall not publish or reproduce such data in whole or in part, or in any manner or form, nor authorize others to do so, without the written consent of the Government until such time as the Government may have released such data to the public. This restriction, however, does not apply to Agreements with academic institutions.

The District and Contractor agree to grant and do hereby grant to the Government and to its officers, agents, and employees acting within the scope of their official duties, a royalty-free, non-exclusive and irrevocable license throughout the world:

- (a) To publish, translate, reproduce, deliver, perform, use and dispose of, in any manner, any and all data not first produced or composed in the performance of this Contract but which is incorporated in the work furnished under this Contract; and
- (b) To authorize others so to do.

District and Contractor shall indemnify and save and hold harmless the Government, its officers, agents, and employees acting within the scope of their official duties against any liability, including costs and expenses, resulting from any willful or intentional violation by the District and Contractor of proprietary rights, copyrights or

rights of privacy, arising out of the publication, translation, reproduction, delivery, performance, use, or disposition of any data furnished under this Contract.

Nothing contained in this clause shall imply a license to the Government under any patent or be construed as affecting the scope of any license or other right otherwise granted to the Government under any patent.

The third and fourth paragraphs under Section 19.0 above are not applicable to material furnished to the District or Contractor by the Government and incorporated in the work furnished under the Contract, provided that such incorporated material is identified by the District or Contractor at the time of delivery of such work.

In the event that the project, which is the subject of this Agreement, is not completed, for any reason whatsoever, all data generated under that project shall become subject data as defined in the Rights in Data clause in this Contract and shall be delivered as the Government may direct. This clause shall be included in all subcontracts under this Contract.

## 20.0 NEW RESTRICTIONS ON LOBBYING

### 20.1 Prohibition

- (a) Section 1352 of Title 31, U.S. Code, provides in part that no appropriated funds may be expended by the recipient of a Federal contract, grant, loan, or cooperative agreement to pay any person for influencing or attempting to influence an officer or employee of any agency, a Member of Congress, an officer or employee of Congress, or an employee of a Member of Congress in connection with any of the following covered Federal actions: the awarding of any Federal contract, the making of any Federal grant, the making of any Federal loan, the entering into of any cooperative agreement, and the extension, continuation, renewal, amendment, or modification of any Federal contract, grant, loan, or cooperative agreement.
- (b) The prohibition does not apply as follows:
  - (i) Agency and legislative liaison by Own Employees.
  - (ii) Professional and technical services by Own Employees.
  - (iii) Reporting for Own Employees.
  - (iv) Professional and technical services by Other than Own Employees.

### 20.2 Disclosure

- (a) Each person who requests or receives from an agency a Federal contract shall file with that agency a certification, included in Form of Proposal or Bid Forms, that the person has not made, and will not make, any payment prohibited by Section 20.1 of this clause.
- (b) Each person who requests or receives from an agency a Federal contract shall file with that agency a disclosure form, Standard Form-LLL, "Disclosure of Lobbying Activities," if such person has made or has agreed to make any payment using non- appropriated funds (to include profits from any covered Federal action), which would be prohibited under Section 20.1 of this clause if paid for with appropriated funds.
- (c) Each person shall file a disclosure form at the end of each calendar quarter in which there occurs any event that requires disclosure or that materially affects the accuracy of the information contained in any disclosure form previously filed by such person under paragraph (c)(2) of this section. An event that materially affects the accuracy of the information reported includes:

- (i) a cumulative increase of \$25,000 or more in the amount paid or expected to be paid for influencing or attempting to influence a covered Federal action; or
  - (ii) a change in the person(s) or individual(s) influencing or attempting to influence a covered Federal action; or
  - (iii) a change in the officer(s), employee(s), or Member(s) contacted to influence or attempt to influence a covered Federal action.
- (d) Any person who requests or receives from a person referred to in paragraph (c)(i) of this section a subcontract exceeding \$100,000 at any tier under a Federal contract shall file a certification, and a disclosure form, if required, to the next tier above.
- (e) All disclosure forms, but not certifications, shall be forwarded from tier to tier until received by the person referred to in paragraph (c)(i) of this section. That person shall forward all disclosure forms to the agency.

20.3 Agreement

In accepting any contract resulting from this solicitation, the person submitting the offer agrees not to make any payment prohibited by this clause.

20.4 Penalties.

- (a) Any person who makes an expenditure prohibited under Section 20.1 of this clause shall be subject to a civil penalty of not less than \$10,000 for each such expenditure.
- (b) Any person who fails to file or amend the disclosure form to be filed or amended if required by this clause, shall be subject to a civil penalty of not less than \$10,000 and not more than \$100,000 for each such failure.
- (c) Contractors may rely without liability on the representations made by their sub- contractors in the certification and disclosure form.

20.5 Cost allowability

Nothing in this clause is to be interpreted to make allowable or reasonable any costs which would be unallowable or unreasonable in accordance with Part 31 of the Federal Acquisition Regulation. Conversely, costs made specifically unallowable by the requirements in this clause will not be made allowable under any of the provisions of Part 31 of the Federal Acquisition Regulation.

## PART VII

### SANTA CRUZ METROPOLITAN TRANSIT DISTRICT PROTEST PROCEDURE

#### PROCUREMENT PROTESTS

All protests shall be filed, handled and resolved in a manner consistent with the requirements of Federal Transit Administration (FTA) Circular 4220.1E Third Party Contracting Guidelines dated June 19, 2003 and the Santa Cruz Metropolitan Transit District's (DISTRICT) Protest Procedures which are on file and available upon request.

Current FTA Policy states that: "Reviews of protests by FTA will be limited to:

- (1) a grantee's failure to have or follow its protest procedures, or its failure to review a complaint or protest; or
- (2) violation of Federal law or regulation.

An appeal to FTA must be received by the cognizant FTA regional or Headquarters Office within five (5) working days of the date the protester learned or should have learned of an adverse decision by the grantee or other basis of appeal to FTA" (FTA Circular 4220.1E, Section 7, paragraph 1., Written Protest Procedures)

Protests relating to the content of this Request for Proposal (RFP) package must be filed within ten (10) calendar days after the date the RFP is first advertised. Protests relating to a recommendation for award solicited by this RFP must be filed by an interested party within five (5) calendar days after the staff's written recommendation and notice of intent to award is issued to the offerors. The date of filing shall be the date of receipt of protests or appeals by the DISTRICT.

All Protests shall be filed in writing with the Assistant General Manager, Santa Cruz Metropolitan Transit District, 370 Encinal Street, Suite 100, Santa Cruz, CA 95060. **No other location shall be acceptable.** The DISTRICT will respond in detail to each substantive issue raised in the protest. The Assistant General Manager shall make a determination on the protest normally within ten (10) working days from receipt of protest. Any decision rendered by the Assistant General Manager may be appealed to the Board of Directors. The Protester has the right within five (5) working days of receipt of determination to file an appeal restating the basis of the protest and the grounds of the appeal. In the appeal, the Protester shall only be permitted to raise factual information previously provided in the protest or discovered subsequent to the Assistant General Manager's decision and directly related to the grounds of the protest. The Board of Directors has the authority to make a final determination and the Board of Director's decision shall constitute the DISTRICT's final administrative remedy.

In the event the protestor is not satisfied with the DISTRICT's final administrative determination, they may proceed within 90 days of the final decision to State Court for judicial relief. The Superior Court of the State of California for the County of Santa Cruz is the appropriate judicial authority having jurisdiction over Proposal Protest(s) and Appeal(s). Bid includes the term "offer" or "proposal" as used in the context of negotiated procurements.

The Offeror may withdraw its protest or appeal at any time before the DISTRICT issues a final decision.

Should the DISTRICT postpone the date of proposal submission owing to a protest or appeal of the solicitation specifications, addenda, dates or any other issue relating to this procurement, the DISTRICT shall notify, via addendum, all parties who are on record as having obtained a copy of the solicitation documents that an appeal/protest had been filed, and the due date for proposal submission shall be postponed until the DISTRICT has issued its final decision.

A letter of protest must set forth the grounds for protest and shall be fully supported with technical data, test results, or other pertinent information related to the subject being protested. The Protestor is responsible for adhering to the DISTRICT's protest procedures.

An Offeror may seek FTA review of the DISTRICT's decision. A protest appeal to the FTA must be filed in accordance with the provisions of FTA circular 4220.1E. Any appeal to the FTA shall be made not later than five (5) working days after a final decision is rendered under the DISTRICT's protest procedure. Protest appeals should be filed with:

Federal Transit Administration  
Regional Administrator Region IX  
201 Mission Street, Suite 2210  
San Francisco, CA 94105-1839



*Desmond, Marcello & Amster  
Valuation and Litigation Consultants*

6060 Center Drive, Suite 825  
Los Angeles, CA 90045  
Tel: (310) 216-1400  
Fax: (310) 216-0800  
Toll Free: (888) 240-5184

225 Bush St., 16<sup>th</sup> Floor  
San Francisco, California 94104  
Tel: (415) 439-8390  
Fax: (415) 439-8391

www.dmavalue.com

August 10, 2004

Mr. Lloyd Longnecker  
District Buyer  
District Purchasing Office  
Santa Cruz Metropolitan Transit District  
120 Dubois Street  
Santa Cruz, California 92501

Re: *Proposal to Provide Goodwill Loss Appraisal Services (RFP No.04-02)*

Dear Mr. Longnecker:

Enclosed herein is Desmond, Marcello & Amster's ("DM&A") proposal to provide loss of goodwill appraisal services to the Santa Cruz Metropolitan Transit District ("the District").

The undersigned, President and owner of DM&A, is authorized to sign on behalf of DM&A and to bind DM&A to a contract,

Ricardo Goñi will act as the contact person regarding the appraisal services proposed herein. He can be contacted at DM&A's San Francisco office at the address, phone number and facsimile number noted on the letterhead,

This proposal is a firm offer for a 90-day period,

Thank you for your consideration of DM&A

Very truly yours,

DESMOND, MARCELLO & AMSTER

Aaron D. Amster, ASA  
President

AA/dkp

Enclosures

G:\users\RFP PACKETS\Santa Cruz RFP doc



PART I  
COMPLETED FORMS

PART II

GENERAL INFORMATION FORM

GOODWILL LOSS APPRAISAL SERVICES, RFP NO. 04-02  
(To be completed by the offeror and placed at the front of your proposal)

DESMOND, MARCELLO & AMSTER                      August 10, 2004  
Legal Name of Firm    Date

225 Bush Street, 16th Floor, San Francisco, CA 94101  
Firm's Address

(415) 439-8390                                      (415) 439-8391  
Telephone Number    FAX Number

corporation                                      95-4354578  
Type of Organization (Partnership, Corporation, etc.)                      Tax ID Number

Offeror understands and agrees that, by his/her signature, if awarded the contract for the project, he/she is entering into a contract with the District that incorporates the terms and conditions of the entire Request for Proposals package, including the General Conditions section of the Request for Proposals. Offeror understands that this proposal constitutes a firm offer to the District that cannot be withdrawn for ninety (90) calendar days from the date of the deadline for receipt of proposals. If awarded the contract, offeror agrees to deliver to the District the required insurance certificates within ten (10) calendar days of the Notice of Award.

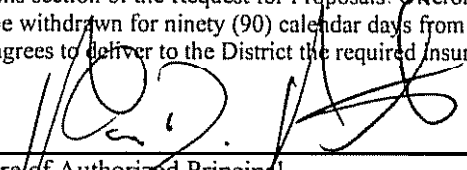
                      Aaron D. Amster, President  
Signature of Authorized Principal

Madeleine Mamaux, Principal  
Name of Principal-in-Charge and Title

Ricardo Goni, Senior Manager  
Name of Project Manager and Title

Ricardo Goni, rgoni@dmava.com (415) 439-8390  
Name, Title, Email Address and Phone Number of Person To Whom Correspondence Should be Directed

225 Bush Street, 16th Floor, San Francisco, CA 94101  
Addresses Where Correspondence Should Be Sent

completion of goodwill loss appraisal services  
Areas of Responsibility of Prime Contractor

Listing of major sub consultants proposed (if applicable), their phone numbers, and areas of responsibility (indicate which firms are DBE's):

NOT APPLICABLE

---

---

---

---

---

LOBBYING CERTIFICATION not applicable  
(Only for Contracts above \$100,000)

Lobbying Certification for Contracts Grants, Loans and Cooperative Agreements (Pursuant to 49 CFR Part 20, Appendix A)

The undersigned certifies, to the best of his or her knowledge and belief, that:

- (1) No Federal appropriated funds have been paid or will be paid, by or on behalf of the undersigned, to any person for influencing or attempting to influence an officer or employee of an agency, a Member of Congress, an officer or employee of Congress, or an employee of a Member of Congress in connection with the awarding of any Federal Contract, the making of any Federal grant, the making of any Federal loan, the entering into of any cooperative agreement, and the extension, continuation, renewal, amendment, or modification of any Federal Contract, grant, loan, or cooperative agreement.
- (2) If any funds other than Federal appropriated funds have been paid or will be paid to any person for making lobbying contacts to an officer or employee of any agency, a Member of Congress, an officer or employee of Congress, or an employee of a Member of Congress in connection with this Federal Contract, grant, loan, or cooperative agreement, the undersigned shall complete and submit Standard Form--LLL, "Disclosure Form to Report Lobbying," in accordance with its instructions and as amended by "Government wide Guidance for New Restrictions on Lobbying," 61 Fed Reg 1413 (11/19/96)
- (3) The undersigned shall require that the language of this certification be included in the award documents for all sub awards at all tiers (including subcontracts, sub grants, and Contracts under grants, loans, and cooperative agreements) and that all sub recipients shall certify and disclose accordingly

This certification is a material representation of fact upon which reliance was placed when this transaction was made or entered into. Submission of this certification is a prerequisite for making or entering into this transaction imposed by 31 U.S.C. § 1352 (as amended by the Lobbying Disclosure Act of 1995). Any person who fails to file the required certification shall be subject to a civil penalty of not less than \$ 10,000 and not more than \$ 100,000 for each such failure

The Bidder/Offeror certifies or affirms the truthfulness and accuracy of each statement of its certification and disclosure, if any. In addition, the Bidder/Offeror understands and agrees that the provisions of 31 U.S.C. A 3801, et. seq apply to this certification and disclosure, if any.

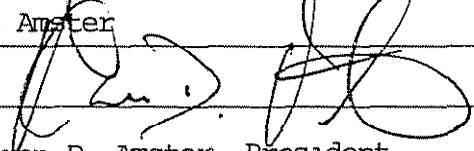
Firm Name Desmond, Marcello & Anster  
Signature of Authorized Official   
Name and Title of Authorized Official Aaron D. Anster, President  
Date August 10, 2004

**BUY AMERICA PROVISION**  
(Only for Contracts above \$100,000)

This procurement is subject to the Federal Transit Administration Buy America Requirements in 49 CFR part 661

A Buy American Certificate, as per attached format, must be completed and submitted with the bid. A bid which does not include the certificate will be considered non-responsive

A false certification is a criminal act in violation of 18 U.S.C. 1001. Should this procurement be investigated, the successful bidder/proposer has the burden of proof to establish that it is in compliance

A waiver from the Buy America Provision may be sought by SCMTD if grounds for the waiver exist

Section 165(a) of the Surface Transportation Act of 1982 permits FTA participation on this contract only if steel and manufactured products used in the contract are produced in the United States,

NOT APPLICABLE  
BUY AMERICA CERTIFICATE

~~The bidder hereby certifies that it will comply with the requirements of Section 165(a) or (b) (3) of the Surface Transportation Assistance Act of 1982, and the applicable regulations in 49 CFR Part 661.~~

~~Date: \_\_\_\_\_  
Signature: \_\_\_\_\_  
Company Name: \_\_\_\_\_  
Title: \_\_\_\_\_~~

OR

~~The bidder hereby certifies that it cannot comply with the requirements of Section 165(a) or (b) (3) of the Surface Transportation Act of 1982, but may qualify for an exception to the requirement pursuant to Section 165(b)(2) or (b)(4) of the Surface Transportation Assistance Act of 1982, as amended, and regulations in 49 CFR 661.7.~~

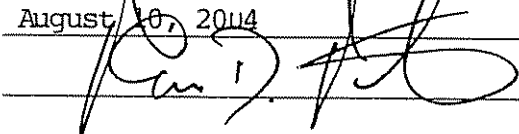
Date: August 10, 2004  
Signature:   
Company Name: Desmond, Marcello & Amster  
Title: President

# CONTRACTOR DBE INFORMATION

not applicable

CONTRACTORS NAME \_\_\_\_\_  
DBE GOAL FROM CONTRACT \_\_\_\_\_ %  
FED. NO. \_\_\_\_\_  
COUNTY \_\_\_\_\_  
AGENCY \_\_\_\_\_  
CONTRACT NO. \_\_\_\_\_

CONTRACTOR'S ADDRESS \_\_\_\_\_  
PROPOSAL AMOUNT \$ \_\_\_\_\_  
PROPOSAL OPENING DATE \_\_\_\_\_  
DATE OF DBE CERTIFICATON \_\_\_\_\_  
SOURCE \*\* \_\_\_\_\_

This information must be submitted during the initial negotiations with the District. By submitting a proposal, offeror certifies that he/she is in compliance with the District's policy. Failure to submit the required DBE information by the time specified will be grounds for finding the proposal non-responsive.

| CONTRACT<br>ITEM NO. | ITEM OF WORK AND DESCRIPTION OF<br>WORK OR SERVICES TO BE SUBCONTRACTED<br>OR MATERIALS TO BE PROVIDED * | CERTIFICATION<br>FILE NUMBER | NAME OF DBE | DOLLAR<br>AMOUNT<br>DBE ***        | PERCENT<br>DBE |
|----------------------|--|------------------------------|-------------|------------------------------------|----------------|
|                      |  |                              |             | TOTAL CLAIMED DBE<br>PARTICIPATION | \$ 0 0 %       |

SIGNATURE OF CONTRACTOR \_\_\_\_\_

DATE \_\_\_\_\_

AREA CODE/TELEPHONE \_\_\_\_\_

(Detach from proposal if DBE information is not submitted with proposal.)

\* If 100% of item is not to be performed or furnished by DBE, describe exact portion, including plan location of work to be performed, of item to be performed or furnished by DBE.

\*\* DBE's must be certified on the date proposals are opened.

\*\*\* Credit for a DBE supplier who is not a manufacturer is limited to 60% of the amount paid to the supplier.

NOTE: Disadvantaged business must renew their certification annually by submitting certification questionnaires in advance of expiration of current certification. Those not on a current list cannot be considered as certified.

# CONTRACTOR DBE INFORMATION

| CONTRACT<br>ITEM NO.               | ITEM OF WORK AND DESCRIPTION OF<br>WORK OR SERVICES TO BE SUBCONTRACTED<br>OR MATERIALS TO BE PROVIDED * | CERTIFICATION<br>FILE NUMBER | NAME OF DBE | DOLLAR<br>AMOUNT<br>DBE *** | PERCENT<br>DBE |
|------------------------------------|--|------------------------------|-------------|-----------------------------|----------------|
| TOTAL CLAIMED DBE<br>PARTICIPATION |  |                              |             | \$ 0                        | 0 %            |

PART II  
PROPOSAL REQUIREMENTS

Section 5.1.1 -Consultant's Experience and Qualifications

*DM&A Background and Overall Qualifications*

Since 1968, DM&A has provided clients in both the public and private sectors with expertise in the valuation of closely-held businesses, professional practices, and specific tangible and intangible assets, such as goodwill. Since the enactment of the California Eminent Domain Law of 1976, DM&A has specialized in providing valuation services for eminent domain proceedings.

DM&A's professional staff consists of fixture and equipment appraisers and business valuation/goodwill appraisers. This multi-disciplinary capability enables DM&A to address complex valuation issues involving both appraisal disciplines. Further, the size of our professional staff enables DM&A to accommodate client needs on large projects with tight deadlines. With professional staff in San Francisco, DM&A is able to provide highly responsive service to our Northern California clients,

DM&A's qualifications are the result of experience gained in the preparation of over one thousand appraisals in a wide range of industries and business types. DM&A's appraisal services fully comply with the Uniform Standards of Professional Appraisal Practice and applicable regulatory and professional procedures. In addition, each senior staff member has extensive experience in the eminent domain and property acquisition process, and detailed understanding of relevant statutory and case law,

Members of the firm hold graduate and undergraduate degrees from the academic institutions of Harvard, Wharton (University of Pennsylvania), Yale, University of Michigan, UCLA, Claremont McKenna College, Loyola Marymount University, University of Southern California, University of California at San Diego, and California State University, Long Beach All firm members are regularly involved in continuing education courses in finance, accounting and valuation.

Individual staff members of DM&A maintain active memberships in various professional associations and hold a variety of professional designations, These include:

*American Society of Appraisers* (Members and Candidates)  
*CFA Institute* (Member)  
*American Institute of Certified Public Accountants* (Member)  
*California Society of Certified Public Accountants* (Member)  
*Institute of Management Accountants* (Member)

Firm members conduct seminars for public agencies, professional appraisal organizations, International Right-of Way chapters, and law firms on the appraisal of goodwill loss in an eminent domain context. Recently, members of the firm have given half and/or full day seminars at the Los Angeles, Sacramento, Oakland, and Fresno IRWA Chapters.

*Prior Experience – Similar and Related Projects*

. Food Product Distributors:

DM&A has prepared goodwill loss appraisals regarding numerous produce distributors and other food distribution firms. For example, we valued the goodwill loss of over ten produce distribution



companies previously located in the Ballpark Project area in San Diego. These assignments involved detailed industry analysis, as well as an understanding of relocation dynamics. Other food processing and distribution companies recently valued by DM&A include a fluid milk plant, a yogurt manufacturer, a fish processor, and a bakery wholesale distributor.

- Equipment Leasing Companies:

DM&A has been engaged to value the goodwill loss of several equipment leasing companies over the past five years, including operations in Ventura County and the Bay Area. These assignments are complex due to the business' significant investment in inventory.

### *Projects Performed for Other Clients*

Since 1976, DM&A has provided goodwill loss appraisal services to government agencies on many large projects statewide. A representative sampling of recent projects include the following list of government and quasi-government agencies:

- Santa Cruz Redevelopment Agency 2000 – present  
Three Projects  
Services: Goodwill loss appraisals  
Scope: 9 businesses
- Bay Area Rapid Transit District. 2000 - present  
BART SFO Extension Project  
Services: Goodwill loss appraisals, litigation support and expert testimony  
Scope: 10 businesses
- City and County of San Francisco 1999 – 2003  
Moscone Convention Center Expansion Project  
Services: Goodwill loss appraisals, litigation support and expert testimony  
Scope: 10 businesses
- City of Redwood City. 2003 – 2004  
Cinema Square Project  
Services: Goodwill loss appraisals, litigations support and expert testimony  
Scope: 6 businesses
- City of Milpitas. 2003 – present  
Library Expansion Project  
Services: Goodwill loss appraisals for acquisition stage of project  
Scope: 5 businesses
- City of Fremont. 2003 -present  
Washington Streetscape Project  
Services: Goodwill loss appraisals for acquisition stage of project  
scope: 7 businesses

- Livermore Redevelopment Agency, 2000 – present  
 Various Projects  
 Services: Goodwill loss appraisals, litigation support and expert testimony  
 Scope: 6 businesses
  
- City of Dublin, 1998 – present  
 Various Projects  
 Services: Goodwill loss appraisals, litigation support and expert testimony  
 Scope: 5 businesses
  
- Los Angeles Unified School District, 2002 -present  
 Various Projects  
 Services: Goodwill loss appraisals, litigation support and expert testimony  
 Scope: Approximately 100 businesses encompassing dozens of projects
  
- Centre City Development Corporation (City of San Diego), 1999 – present  
 Ballpark Project  
 Services: Goodwill loss appraisals, litigation support and expert testimony  
 Scope: Over 75 businesses
  
- State of California Department of Transportation (CALTRANS), 2002 - present  
 State Route 60/91/215 Project (District 11)  
 State Route 52 Project (District 8)  
 State Route 101 Project (District 4)  
 Services: Goodwill loss appraisals, litigation support and expert testimony  
 Scope: Approximately 20 businesses to date

NOTE: This is a representative list, It does not include all agencies DM&A is currently engaged by or has been engaged by over the last three years.

#### Section 5.1.2 -Understanding of the Scope of Work

##### *Subject Businesses*

The District is seeking goodwill loss appraisal services for an Odwalla distribution facility, a produce distributor (Surf City Produce), and an equipment leasing company (A Tool Shed). In order to gain further insight into the level of analysis required for each of these businesses, Mr. Gouli of our San Francisco office met with Frank Cheng, Project Manager for the District. During their meeting, Mr. Gouli performed a limited site inspection of each of the businesses and all proposed relocation sites. With respect to the Odwalla distribution facility and Surf City Produce, it is our understanding that both businesses are contemplating relocating to 120 Dubois Street. Additionally, we understand that A Tool Shed is poised to relocate to 375 Encinal Street for an approximate 2-year period before permanently relocating to 111 Dubois Street. The above relocation sites are all located within a one-mile radius of their respective current sites,

##### *Scope of Work – Preliminary Goodwill Loss Estimates*

DM&A's approach to the appraisal process is thorough, collaborative, and professional. Our appraisers recognize the importance of a detailed approach to any assignment, and are cognizant of our role as

representing our clients,. Our professionals have extensive experience interviewing business owners, and make efforts to address their concerns and needs in these meetings., DM&A has bilingual professionals to interface with Spanish-speaking business owners. We work closely with agency staff and their attorneys in order to keep all parties apprised of the status of our appraisal projects.

In preparing preliminary goodwill loss appraisals for the District, DM&A will perform the necessary research, investigation, and analysis to provide briefwritten appraisal reports in compliance with the standards of the Uniform Standards of Professional Appraisal Practice (USPAP) as it pertains to business valuations. DM&A's work will encompass steps including, but not limited to, the following:

- Review and analysis of financial statements of the subject business, including internal income statements and balance sheets as well as tax returns;
- Interviews with the owners and/or managers of the subject business,, Such interviews are intended to provide DM&A with a thorough understanding of the business' products, operations, management, employees, marketing, competition, and industry, as well as an understanding of recent financial trends and outlook;
- Site and area inspections of both the subject location and the business' relocation site, if applicable;
- Review of leases and other contracts pertinent to the business' operations;
- Coordination with other professionals, such as fixtures and equipment appraisers, real estate appraisers, and relocation consultants, to avoid duplication of compensation;
- Independent research in the business' industry and the economic factors affecting the business;
- Research into the marketplace for sales of businesses similar to the subject;
- Investigation of the impact of the taking and/or of relocation, if applicable, on the business' revenues and profits in the "after" condition; and
- Implementation of valuation methods, such as the Income Approach and Market Approach, to determine the value of the business' goodwill in both the before condition and in the after condition.,

#### *Scope of Work -- Comprehensive Goodwill Loss Appraisals*

In preparing comprehensive goodwill loss appraisals, DM&A will perform the functions described above in the preliminary goodwill loss appraisal discussion. However, the level of scrutiny employed in the comprehensive goodwill loss appraisal is significantly greater. Further, we will coordinate with relocation consultants to evaluate the business' efforts to mitigate goodwill loss. Our findings will be presented in a fully contained appraisal report or a statement of value suitable for court exchange,

#### *Scope of Work - Other*

DM&A is available to provide litigation support services on any of these businesses. These services would include, but are not limited to, aiding the District's attorneys in the discovery process, reviewing opposing expert appraisals, and testifying at deposition and/or trial. It should be noted that fee estimates

contained herein are exclusive of litigation support services. These services are available at our standard hourly rates.

**Section 5.1.3 - Project Personnel**

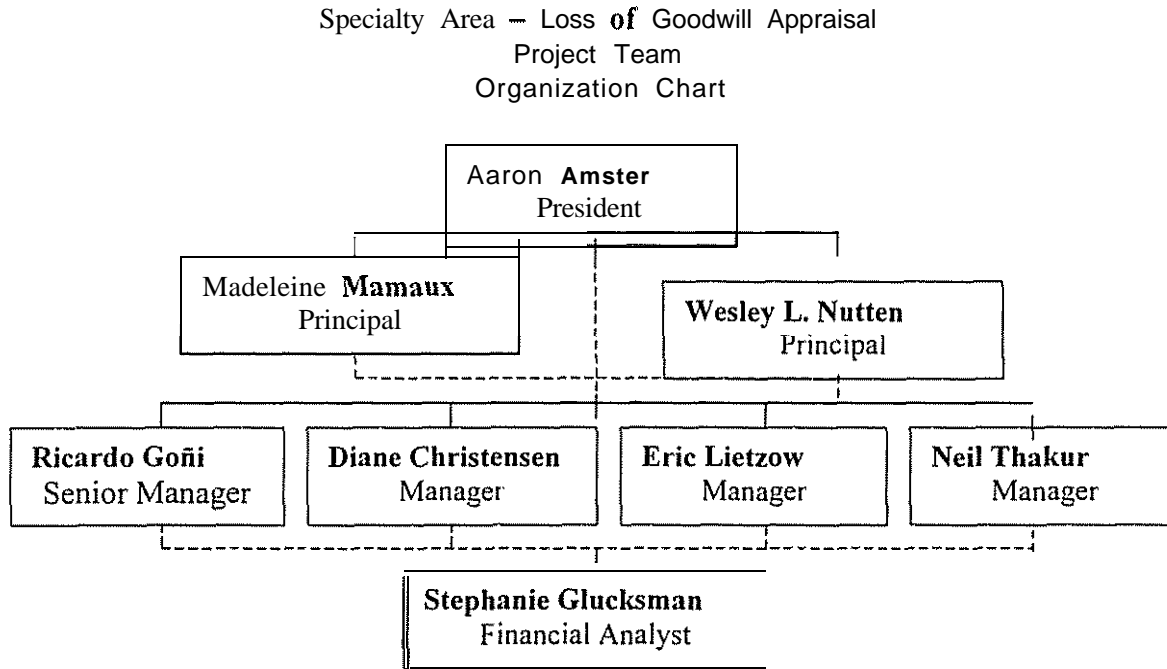

DM&A’s staffing includes eight appraisal professionals dedicated to business and goodwill loss valuation assignments. DM&A’s president, principals and senior managers are responsible for project management and supervision of appraisal staff. Appraisers and managers are responsible for gathering and analyzing data, researching valuation methods and data, and compiling appraisal reports. Analysis and application of valuation methods are performed collaboratively among appraisers, managers and principals. DM&A’s president and/or principals make final determinations of value and would be called upon to provide expert testimony as needed.

Any additions or substitutions of Key Personnel will require prior written approval by the City and/or Agency. Professionals assigned to this project will be located in both our San Francisco and Los Angeles offices.

*Resumes of Key Personnel*

SAN FRANCISCO OFFICE

**RICARDO A. GOÑI**  
SENIOR MANAGER

Education: Mr. Goñi holds a bachelor's degree from Harvard University, where he majored in economics. Representative coursework included finance, accounting, and statistics.

General Experience: Mr. Goñi joined DM&A as a financial analyst in 1997 and now serves as a senior manager. He opened DM&A's Northern California office in 2000. While with DM&A, he has gained a wide range of business valuation experience, and has prepared over a hundred valuations of goodwill loss. In recent years, Mr. Goñi has focused on complex litigation cases, involving partial and full property takings,,

Specialized Education and Training and Local Government Experience: Mr. Goñi has attended various seminars and presentations related to eminent domain and business valuation. He has worked with numerous government agencies and attorneys throughout the state.

Certifications and Other Information: Having passed the first three examinations of the business valuation discipline administered by the American Society of Appraisers, Mr. Goñi is continuing his coursework. He is active in various associations in Northern California, including local chapters of the International Right of Way Association.

**NEIL THAKUR**  
VALUATION MANAGER

Education: Mr. Thakur graduated from Yale University with a bachelor's degree in economics.

General Experience: Mr. Thakur recently rejoined DM&A after holding positions in the investment and business valuation industries. From 1999 through 2001, Mr. Thakur was a financial analyst at DM&A, where he was responsible for preparing loss of goodwill appraisals in eminent domain matters. His other work experience includes investment analysis in the technology investment banking department at ABN Amro. Subsequently, he was a valuation professional at FMV Opinions, where he prepared business appraisals for purposes including gift and estate tax returns, financing and partnership dissolutions.

Specialized Education and Training and Local Government Experience: As a member of DM&A's professional staff, Mr. Thakur has experience working with various local government agencies and their attorneys regarding loss of goodwill appraisal issues.

Certifications and Other Information: Mr. Thakur has completed some coursework towards his ASA designation, and intends to continue his professional education.

## LOS ANGELES OFFICE

AARON D. AMSTER, ASA  
PRESIDENT

Education: Mr. Amster holds a bachelor's degree in economics from the University of Michigan and a master's degree in business administration from the Claremont Graduate School of Business. He has concentrations in both finance and marketing.

General Experience: Having joined DM&A in 1981, Mr. Amster has been president since 1992. He has more than 20 years of experience in business valuation and has participated in a majority of DM&A's valuation assignments during his tenure. Mr. Amster specializes in the valuation of businesses and business assets, including loss of goodwill in eminent domain proceedings. In addition, he has performed various analyses of business damages. His extensive testimony experience includes more than 40 appearances in court and hundreds of depositions. He has appeared as an expert witness in a variety of jurisdictions, including Southern California, Northern California, Arizona, Ohio, Florida, and U.S. Bankruptcy court

Specialized Education and Training and Local Government Experience: Mr. Amster has participated in and/or attended numerous seminars regarding goodwill loss appraisal issues in California. He has worked closely with representatives of local governments throughout the state and made various presentations to staff and elected officials regarding goodwill loss issues.

Certifications and Other Information: Mr. Amster achieved the Accredited Senior Appraiser designation from the American Society of Appraisers (Business Valuation Discipline) in 1989. He was a contributing author of *Handbook of Small Business Valuation Formulas* and technical editor of *Handbook of Small Business Valuation Formulas and Rules of Thumb*. In addition, he regularly presents seminars on topics related to the appraisal of goodwill loss pursuant to Section 1263.510 of the California Eminent Domain Law,

MADELEINE MAMAUX, CFA  
PRINCIPAL

Education: Ms. Mamaux graduated magna cum laude with a bachelor's degree from Claremont McKenna College. She majored in economics and mathematics and was elected to Phi Beta Kappa. She holds a master's degree in business administration from The Wharton School of the University of Pennsylvania, graduating with distinction with a degree in finance.

General Experience: Ms. Mamaux began her business valuation career as a financial analyst at DM&A from 1989 to 1991. She left to earn her MBA and gained significant analytical experience in the investment industry before rejoining DM&A in 1997 as valuation manager. As a professional at DM&A, Ms. Mamaux has prepared hundreds of goodwill loss appraisals and supervised staff in many more. She has provided testimony in Los Angeles Superior Court and in arbitration proceedings, as well as in depositions. Other positions held by Ms. Mamaux included analyzing investment opportunities in fixed-income securities for Teachers' Insurance and Annuity Association (TIAA), the nation's largest private pension fund. She also worked for Fitch Investors Service, an international bond-rating agency, where she was responsible for assigning credit ratings to large multinational companies.

Specialized Education and Training and Local Government Experience: During over 10 years with DM&A, Ms. Mamaux has worked with local government staff and attorneys throughout the state,

Certifications and Other Information: A Chartered Financial Analyst, Ms. Mamaux is a member of the Association of Investment Management and Research and the Los Angeles Society of Financial Analysts. Ms. Mamaux has spoken on several occasions on topics related to business valuation and goodwill loss under the California eminent domain law,

WESLEY L. NUTTEN, CPA, CMA, ABV  
PRINCIPAL

Education: Mr. Nutten earned a bachelor's degree in business from the University of Southern California with an emphasis in finance. He holds a master's degree in business administration from Loyola Marymount University with a concentration in finance and entrepreneurial organizations.,

General Experience: With more than 16 years of litigation consulting experience, Mr. Nutten is an expert on damages issues, business valuation matters, and fraud investigations. Further, he has performed numerous appraisals of goodwill loss under California's eminent domain law. He has testified in California Superior Court and California Criminal Court, as well as in various local jurisdictions. Before joining DM&A in 2001, Mr. Nutten gained valuable experience as a management consultant at Price Waterhouse, BDO Seidman, Peterson Consulting, and Biggs & Co. His prior experience includes damage analysis, forensic accounting, litigation consulting services, business valuations, and class-action claims administration

Specialized Education and Training and Local Government Experience: Mr. Nutten has worked on eminent domain valuation matters with various local agencies as a member of DM&A's professional staff. Further, he has prepared damage analyses and forensic accounting studies for local governments including the City of Los Angeles.

Certifications and Other Information: Mr. Nutten is a Certified Public Accountant in California, a Certified Management Accountant, and Accredited in Business Valuation. He maintains membership in the American Institute of Certified Public Accountants, the California Society of Certified Public Accountants, and the Institute of Management Accountants. Previously, he was a professor of Financial and Managerial Accounting in the MBA program at Loyola Marymount University, Los Angeles.

DIANE MAY CHRISTENSEN, CPA, AM  
VALUATION MANAGER

Education: Ms. Christensen holds a bachelor's degree in economics/accounting from Claremont McKenna College. Honors include Phi Beta Kappa and Academic All-American.

General Experience: Ms. Christensen has been a valuation manager with DM&A since 2000. During her tenure at the firm, she has completed numerous goodwill loss appraisals across a wide range of industries. Her prior experience includes investigative auditing and determining economic damages for insurance matters, catastrophic events, fraud, and a variety of economic disputes. Before joining DM&A, Ms. Christensen worked as a manager in the Los Angeles office of RGL Gallagher, an international forensic accounting firm. She also had previous experience in the audit department of Deloitte & Touche.

Specialized Education and Training and Local Government Experience: Ms. Christensen has worked closely with numerous local government officials and attorneys since joining DM&A. She has been active in various IRWA chapters in Southern California to expand her knowledge of the eminent domain process.

Certifications and Other Information: Ms. Christensen is a Certified Public Accountant in California. She maintains membership in the American Institute of Certified Public Accountants (AICPA), and the California Society of Certified Public Accountants. She has achieved the Accredited Member designation of the American Society of Appraisers. She has also completed various courses related to business valuation administered by the AICPA.

**ERIC R. LIETZOW, CPA**  
**VALUATION MANAGER**

Education: Mr. Lietzow holds a bachelor's degree in business administration accountancy from California State University, Long Beach, where he graduated magna cum laude.

General Experience: Mr. Lietzow joined DM&A in 2001, bringing over five years of experience in litigation consulting and forensic accounting. At the firm, he works on economic damage cases, general business valuation and loss of goodwill appraisal assignments. He also manages claims administration activities for large class action settlements. Prior to joining DM&A, he was a manager in the litigation consulting services department at BDO Seidman and gained experience at Biggs & Co. Previously, he worked in the internal accounting department of WGI Solutions, an employment services company.

Specialized Education and Training and Local Government Experience: Mr. Lietzow has attended seminars regarding goodwill loss appraisal issues under California law, and has worked with DM&A's public agency clients since joining the firm.

Certifications and Other Information: Mr. Lietzow is a Certified Public Accountant and maintains membership in the American Institute of Certified Public Accountants, the California Society of Certified Public Accountants, and the Association of Certified Fraud Examiners. He has completed the first two of four courses provided by the American Society of Appraisers in the business valuation discipline.

**STEPHANIE GLUCKSMAN**  
**FINANCIAL ANALYST**

Education: Ms. Glucksman holds a bachelor of arts degree from the University of California at San Diego, having majored in economics and minored in psychology. She earned various honors including membership in the Golden Key National Honor Society and Provost Academic Honors.

General Experience: Prior to joining DM&A in 2004, Ms. Glucksman gained valuable experience for two years as a financial analyst at Palomar Pomerado Health, which owns and operates hospitals in San Diego County.

Specialized Education and Training and Local Government Experience: Ms. Glucksman will be expanding her knowledge of the eminent domain arena of valuation via work experience and attending relevant courses and seminars.



Certifications and Other Information: A member of the Healthcare Financial Management Association, Ms. Glucksman will be participating in ASA coursework in business valuation and other continuing education.

Section 5.1.4 -References

1. Herman Fitzgerald, Esq.  
Law Offices of Herman H. Fitzgerald  
345 Lorton, Suite 302  
Burlingame, CA 94010  
(650) 348-5195  
Cinema Square Project, Redwood City
2. David Skinner, Esq.  
Meyers, Nave, Riback, Silver & Wilson  
555 12th Street, Suite 1500  
Oakland, CA 94607  
(510) 808-2031  
Various projects for the City of Dublin and the Livermore Redevelopment Agency
3. Martin Greenman, Esq.  
Assistant City Attorney  
City of San Francisco  
234 City Hall  
San Francisco, CA 94102  
(415) 554-4645  
Moscone Convention Center Expansion Project
4. John Vlahos, Esq.  
Hanson, Bridgett, Marcus, Vlahos & Rudy  
333 Market Street, 23rd Floor  
San Francisco, CA 94105  
(415) 777-3200  
BART SFO Extension Project
5. Ceil Cirillo  
Santa Cruz City Redevelopment Agency  
337 Locust street  
Santa Cruz, CA 95060  
(831) 420-5150  
Various Assignments
6. Anthony P. Condotti, Esq.  
Atchison, Barisone, Condotti & Kovacevich  
333 Church Street  
Santa Cruz, CA 95060  
(831) 423-8383  
Various Assignments

Section 5.1.5 – Sub Consultants

DM&A does not intend to use any subcontractors to fulfill this contract.

Section 5.1.6 -Conflict of Interest

DM&A does not have any financial, business or other relationship with the District or any of its officers or officials which would have an impact upon the outcome of our work. To our knowledge, no current DM&A client has a financial interest in the outcome of our work.

Section 5.1.7 -Professional Services Contract

DM&A has no objections to the terms and conditions of the sample agreement attached to the subject RFP.

DM&A acknowledges that the final contract shall be in substantially the same form and content as the “Professional Services Contract” attached to the subject RFP. DM&A has no objections to the terms and conditions of this agreement.

Section 5.1.8 -Signature

Please see the attached cover letter.

Section **5.1.9**- Fee Schedule

Hourly rates applicable to all staff proposed to work on the District’s project appear below. No overtime hourly rates, mileage costs, or additional billing requirements are applicable in addition to these rates.

**DESMOND, MARCELLO & AMSTER  
HOURLY RATE SCHEDULE  
LOSS OF GOODWILL APPRAISAL PROFESSIONALS**

| <u>Title</u>      | <u>Staff Member</u> | <u>Standard Rate</u> | <u>Depo/Court Appearance Rate</u> |
|-------------------|---------------------|----------------------|-----------------------------------|
| President         | Aaron Amster        | \$250                | \$350                             |
| Principal         | Wesley Nutten       | 250                  | 350                               |
| Principal         | Madeleine Mamaux    | 225                  | 300                               |
| Senior Manager    | Ricardo Goñi        | 175                  | 250                               |
| Valuation Manager | Diane Christensen   | 150                  | 200                               |
| Valuation Manager | Eric Lietzow        | 150                  | 200                               |
| Valuation Manager | Neil Thakur         | 150                  | 200                               |
| Financial Analyst | Stephanie Glucksman | 125                  | N/A                               |

Section 5.1.10 -Project Fee Estimate

Based on our observation of the subject businesses described previously, our fee estimates are as follows:

*Preliminary Goodwill Loss Appraisals – Per Business*

| <u>Estimated Personnel Hours and Rates</u> |            | <u>Total</u> |
|--|------------|--------------|
| President/Principal                        | 8 @ \$250  | \$2,000      |
| Senior Manager                             | 10 @ \$175 | 1,750        |
| Manager                                    | 25 @ \$150 | <u>3,750</u> |
|  |            | \$7,500      |

*Comprehensive Goodwill Loss Appraisals – Per Business*

| <u>Estimated Personnel Hours and Rates</u> |            | <u>Total</u> |
|--|------------|--------------|
| President/Principal                        | 15 @ \$250 | \$3,750      |
| Senior Manager                             | 20 @ \$175 | 3,500        |
| Manager                                    | 35 @ \$150 | <u>5,250</u> |
|  |            | \$12,500     |

It should be noted that the above fees are exclusive of any litigation support functions, as described above. Litigation support services are provided on an hourly basis.

# SANTA CRUZ METROPOLITAN TRANSIT DISTRICT

## STAFF REPORT

**DATE:** September 24, 2004

**TO:** Board of Directors

**FROM:** Margaret Gallagher, District Counsel

**SUBJECT:** **CONSIDERATION OF MODIFICATIONS TO SANTA CRUZ METRO'S BYLAWS TO CLARIFY THAT APPOINTEES TO THE METROS ADVISORY COMMITTEE (MAC) SERVE AT THE PLEASURE OF THE BOARD OF DIRECTORS**

### I. RECOMMENDED ACTION

**Modify Santa Cruz METRO's Bylaws in accordance with Attachment D, which would Clarify that Appointees to MAC Serve at the Pleasure of the Board of Directors**

### II. SUMMARY OF ISSUES

- On October 24, 2003, the Santa Cruz METRO's Board of Directors approved replacing the Metro Users Group (MUG) with a new advisory committee that was designated the METRO Advisory Committee (MAC).
- On December 19, 2003, the Board of Directors modified Santa Cruz METRO's Bylaws to reflect the creation of MAC and the elimination of MUG. The Board also approved MAC's Bylaws.
- On March 12, 2004, Santa Cruz METRO's Directors nominated individuals from the community to be considered by the Board of Directors for appointment to MAC.
- On March 26, 2004, the Board of Directors appointed eleven individuals to serve on MAC.
- MAC held its first meeting in April 2004, and has met monthly since that date.
- On April 19, 2004, Bonnie Morr, Chairperson of the United Transportation Union, Local 23, forwarded a letter (Attachment C) to Emily Reilly, the Chair of the METRO Board of Directors in which she asked for a discussion regarding removal of a MAC appointee.
- The Board of Directors asked that this matter be agendaized so that the matter could be fully discussed.
- METRO staff attended the August 18, 2004, MAC meeting and discussed specific language for the METRO Bylaws.

### III. DISCUSSION

For many years Santa Cruz METRO was served by two advisory groups: the METRO Users Group (MUG) and the METRO Accessible Services Transit Forum (MASTF). However, in the Fall of 2003, the Board of Directors determined that it would be better served by replacing MUG with a new advisory group which it called the METRO Advisory Committee (MAC) in which individual directors of the Board nominate individuals to serve on the committee and the Board of Directors makes the actual appointments. The Board of Directors modified its Bylaws to reflect the creation of MAC as an 11-member advisory group. The Bylaws provide for the method of appointments but do not address the issue of removal of a MAC member. METRO's Bylaws do provide that the Board of Directors shall approve bylaws to be followed by MAC (Attachment A).

MAC's Bylaws provide for each appointee to serve a two-year term and allows for members to be reappointed for two successive terms for a total of 6 consecutive years. The only allowance for the removal of a MAC member is if a position automatically is declared vacant because a MAC appointee was absent without excuse from four committee meetings in any twelve-month period (Attachment B).

In her April 19, 2004, letter (Attachment C) regarding the "Removal of an Appointee", UTU Chairperson Bonnie Morr expressed concerns regarding an "appointee's accountability to the public they serve and the Board that appointed them". Ms. Morr wrote:

We feel that an area that needs introduction, discussion and procedural language created is for the "Removal of an Appointee". Should the individual's behavior not be conducive nor display a commitment that will support the Santa Cruz Metropolitan District and/ or its policies, ridership, service or employees; what is to be done to rectify the issue?

Santa Cruz METRO's Board of Directors has broad authority to create advisory groups and committees and to make appointments to such groups, as it deems necessary, unless otherwise limited by its enabling statutes or the general laws of this state. METRO's enabling statutes direct the Board of Directors to provide for "all matters and things necessary for the proper administration of the affairs of the District" which are not otherwise specifically provided for (Public Utilities Code §98111). The Board of Directors, therefore establishes the powers, duties, and method of appointment for such groups. While the Board of Directors can establish criteria for such appointments for membership on its groups and committees, it must insure that the criteria does not discriminate based on sex, race, creed, color or national or ethnic origins (Cal. Constitution Article 1, Section 8). Because these groups and committees are created by the Board of Directors, the Board retains authority to eliminate the group itself or remove a particular member. Indeed, during the discussions regarding whether MASTF should remain an advisory group, the point was often made that MASTF's membership as an "independent body" could not be affected by the Board of Directors whereas the membership of an advisory body actually created by the Board itself could be impacted by Board action.

Clearly, the Board could, through an affirmative vote of 6 of its members eliminate MAC or modify the number of appointments or change the subject matter jurisdiction of MAC through a modification to the Bylaws. Adding language such as, "Appointments to MAC serve at the pleasure of the Board of Directors" would make it clear that the Board of Directors retain authority to remove an appointed member.

In adopting this or similar language, the Board of Directors must be cognitive of the constitutional tenet that public officials may not deny or deprive a person of a government benefit or privilege on a basis that infringes on the person's constitutionally protected interests including his/her interest in freedom of speech (*Perry v. Sinderman*, 408 U.S. 593, 92 S. Ct 2694, 33 L. Ed 2d 570 (1972)). United States Supreme Court cases recognize a variety of public benefits, in addition to public employment, which cannot be denied because of the recipient's exercise of constitutional rights (*Rutan v. Republican Party*, 497 U.S. 672 110 S. Ct 2729, 111 L. Ed 2d 52 (1990)). Retaliatory actions, such as loss of a government volunteer position, have been held egregious enough to invoke the protections of the Constitution because a person is being punished for engaging in protected speech (*Hyland v. Wonder*, 972 F.2d 1129 (9<sup>th</sup> Cir. 2992)). The *Hyland* Court reasoned that a government volunteer position could be found to be a government benefit or privilege because as a government volunteer, a person gains valuable experience and education in public administration and can make professional contacts. The Court went on to observe that the opportunity to serve as a volunteer is also important because it provides an individual the satisfaction of making a contribution or giving something back to society. (*Hyland*, supra, at 1135-1 136). Therefore, even though an individual has no right to a valuable government benefit, such as a volunteer appointment, and even though the government may deny him/her the benefit for any number of reasons, there are some reasons upon which the government may not rely. It may not deny a benefit to a person on a basis that infringes his constitutionally protected rights including his/her right to freedom of speech.

Because it is likely that in accordance with the *Hyland* Court analysis an appointment to MAC would be considered a valuable governmental benefit or privilege, any removal of such appointee would be disallowed if it were in retaliation for the exercise of constitutionally protected rights.

In this inquiry it is important to know that not all speech is protected from retaliation by the government acting in its capacity as employer/supervisor. The U.S. Supreme Court formulated the "public concern" test in an effort to find a compromise between the rights of public employees to free speech and of the government to regulate its workplace (*Pickering v. Board of Education*, 391 U.S. 563, 88 S. Ct. 1731, 20 L. Ed. 2d 811 (1968)). A dismissal from employment or other loss of a governmental benefit as a consequence of speech does not run afoul of the First Amendment unless the speech addresses a matter of public concern. Determining whether speech involves a matter of public concern entails an inquiry into the "content, form, and context of a given statement, as revealed by the whole record." (*Hyland*, *infra* at 1137).

Additionally, any constitutional inquiry must include an analysis of whether the speech so severely damaged harmony and working relationships that the government's interest in

promoting an effective workplace outweighs the individual's First Amendment rights. This is a factual question that must be decided on a case-by-case basis (*Hyland at 1139-1140*).

In conclusion, the Board of Directors has broad authority to form groups and committees in the proper administration of Santa Cruz METRO's affairs. The Board retains authority to modify or eliminate these groups at its discretion. As discussed above, appointees to those committees serve at the pleasure of the Board of Directors except that appointees cannot be removed for illegal reasons.

MAC reviewed this matter with METRO staff at its August 2004 meeting and intends to consider possible language regarding this issue at its September 2004 meeting. MAC recognizes the ability of the Board of Directors to remove MAC appointees but wanted the Board and the public to understand that the Board's power to remove is not unlimited, but must adhere to legal mandates.

#### **IV. FINANCIAL CONSIDERATIONS**

None

#### **V. ATTACHMENTS**

- Attachment A:** UTU Chairperson Bonnie Morr's April 19, 2004 Letter
- Attachment B:** Letter to MAC including proposed language to amend Santa Cruz METRO's Bylaws re removal of MAC appointees.

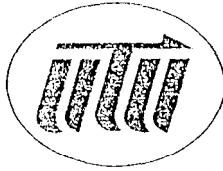

Attachment **A**

*united transportation union*

Board of Directors  
Santa Cruz Metro Transit District

April 19, 2004

Attention Chairperson Reilly,

United Transportation Union Local 23 is writing this letter due to concerns that have arisen around the charter and bylaws being discussed for the Metro Advisory Committee (MAC).

An area that has come to light, and has not been currently addressed by Staff or the Board is the issue around the appointees and their code of behavior. We, the members of the UTU, as the primary public service providers for the district, have concerns about appointee's accountability to the public they serve and the Board that appointed them.

We feel that an area that needs introduction, discussion and procedural language created is for the "Removal of an Appointee". Should the individual's behavior not be conducive nor display a commitment that will support the Santa Cruz Metropolitan District and/or its policies, rider ship, service or employees; what is to be done to rectify the issue?

What is acceptable behavior? What about issues around felonies or convictions for certain crimes? Will these appointees be briefed and held to the standards of current District Policies, such as; the Sexual Harassment and Workplace Violence Policies? Will these appointees be made to complete Disclosure forms for tax purposes as other Public Commissions currently do? How will you protect your employees from disgruntled members who do not get their way or object to differing courses of action taken by the Transit District?

We realize that the Board of Directors must be tired of discussing this issue with so many pressing issues at hand. However, UTU feels that these are areas that need discussion and would like to see this added to the agenda and responded to by District's Legal Counsel.

I would like to remind you of a situation that occurred several years ago, in whereas a Board Member was having difficulties in public, on our coaches and with bus operators. At that time, the Board of Directors was powerless to effectually deal with the situation. It took quite a bit of time and money to rectify that situation. We do not want to see a repeat of those circumstances.

Respectfully,

*Bonnie Morr* (Signature)

Bonnie Morr  
chairperson UTU Local 23

12A.a1



*Santa Cruz Metropolitan  
Transit District*



**Attachment b**

August 23, 2004

Metro Advisory Committee (MAC)  
c/o Santa Cruz Metropolitan Transit District  
370 Encinal Street, Suite 100  
Santa Cruz, CA 95060

Re: Removal of Appointees to MAC's Board of Directors

Dear Members of MAC:

It was a pleasure attending the MAC August meeting. I was impressed with your thoughtful and respectful approach to issues.

At the meeting, we discussed my staff report regarding the removal of MAC appointees. I am providing you with language for your review and consideration that could be used by the Board of Directors to modify its Bylaws on this issue:

1. Appointees serve at the pleasure of the Board of Directors;
2. Appointees serve at the pleasure of the Board of Directors, except that no appointee will be removed from office for an illegal reason including the exercise of his/her right to speak about matters of public concern"

I look forward to your meeting on September 15, 2004 when we will have the opportunity to discuss this matter in greater detail. Thank you for your attention to this matter.

Very truly yours,

Margaret Gallagher  
District Counsel

MG/rjd  
cc: Leslie White, General Manager

12A.b1

# SANTA CRUZ METROPOLITAN TRANSIT DISTRICT

## STAFF REPORT

**DATE:** September 24, 2004

**TO:** Board of Directors

**FROM:** Margaret Gallagher, District Counsel

**SUBJECT:** **CONSIDERATION OF MODIFICATIONS TO SANTA CRUZ METRO'S BYLAWS INCLUDING ADDING RULES OF PROCEDURE FOR BOARD MEETINGS, SELECTING REPRESENTATIVES TO THE SANTA CRUZ COUNTY REGIONAL TRANSPORTATION COMMISSION, SETTING RULES FOR PUBLIC TESTIMONY ON AGENDA ITEMS AND OTHER CHANGES**

### I. RECOMMENDED ACTION

**Approve the attached Resolution which includes modification to the Santa Cruz METRO's Bylaws and discontinue use by the Board of Directors of the previously adopted SCMTD Rules of Order (Attachment B)**

### II. SUMMARY OF ISSUES

- Generally, on an annual basis, the Board of Directors of Santa Cruz METRO reviews its bylaws to determine if modifications are warranted.
- Santa Cruz METRO's enabling statute provides that the Board of Directors shall make its own rules of procedure and determine the place and time of its meetings (Public Utilities Code Section 98 105).
- In March, the Board of Directors reviewed the Bylaws and suggested minor word changes to correct grammar errors, to have the Chair of the Board nominate the representatives and the alternates to the Santa Cruz County Regional Transportation Commission (SCCRTC), and to include Rules of Procedures for Board of Director meetings.
- At the April 2004 Board Meetings, the Board of Directors closely reviewed the method used to nominate representatives and alternates to the SCCRTC.
- At the May 28, 2004 meeting, this matter and the staff report regarding public testimony rights were continued to the June Board meeting due to time constraints.
- At the July 2004 meeting, the Board of Directors inquired regarding the development of language allowing the chair of the board to set time limits on public testimony as needed.
- Director Pat Spence inquired whether the annual appointments to the SCCRTC should be made in February rather than January.

### III. DISCUSSION

Generally, on an annual basis, the Board of Directors of Santa Cruz METRO reviews its Bylaws to determine if modifications are warranted. Santa Cruz METRO's enabling statute provides that the Board of Directors shall make its own rules of procedure and determine the place and time of its meetings (Public Utilities Code Section 98 105). Additionally, Public Utilities Code Section 98 132 provides that the Board shall establish rules for its proceedings.

During the March 26, 2004, Board of Directors' regular meeting, the Board of Directors reviewed the Bylaws and individual Board Members suggested that certain grammatical errors be corrected, that Section 3.01 be divided into sub-parts for easier reading, that Section 14.02(a) be amended to specifically authorize that the Chair nominate the alternates as well as the METRO representatives to the SCCRTC and that Rules of Procedure be incorporated into the By-laws. These changes were incorporated into the proposed By-laws and reviewed at the April 2004 meetings. Attachment A contains the proposed Bylaws Resolution with the proposed modifications set forth in bolded letters or with strike-outs. Revised Rules of Procedure are attached to the Bylaws in order to facilitate the meetings.

Additionally, at the March Board meeting, Director Rotkin informed the Board of Directors that sometime during the 1980s, the Board of Directors adopted specific Rules of Procedure. Director Rotkin provided these rules and they are incorporated as Attachment B.

At the April 2004, meetings various nomination methods for the selection of the representatives and alternates to the SCCRTC were reviewed and discussed.

At the May 28, 2004, regular meeting, the Board of Directors did not have sufficient time to discuss the staff report that addressed public testimony rights and so the matter was continued to the July meetings.

At this time, the Board of Directors is considering modifications to Section 11 .01 of the Bylaws, which addresses public testimony. The current language allows individuals addressing the Board to limit their remarks to 5 minutes and if more than 5 people wish to speak on an item than the limit is reduced to 3 minutes. The Brown Act allows the Board of Directors to adopt reasonable regulations limiting the total amount of time allocated for public testimony on a particular issue and for each individual speaker. At the July 23, 2004 meeting, the Board of Directors asked that language be developed which would allow the Chair of the Board to set time limitations for public testimony during a meeting depending on the circumstances. The Board wished to have this issue studied so as to avoid any possible public testimony rights violations.

Government Code Section 54954.3 provides that METRO's regular meeting agendas must include an opportunity for members of the public to directly address the legislative body on any item of interest to the public, before or during the consideration of an item,

that is within METRO's subject matter jurisdiction. At all special meetings, the public must have the opportunity to speak to the matter under consideration before or during any consideration of the matter. Government Code Section 54954.3 goes on to authorize the METRO Board of Directors to adopt reasonable regulations to ensure that the intent of requiring public testimony rights on an agenda is carried out, including but not limited to adoption of reasonable regulations limiting the total amount of time allocated for public testimony on particular issues and for each individual speaker. The Public Utility Code sections cited above and Government Code Section 54954.3(b) vest wide discretion in METRO's Board of Directors to adopt rules concerning the conduct of its proceedings so long as such discretion is exercised reasonably and not in an arbitrary or capricious manner (*Nevens v. City of Chino* (1965) 233 Cal. App. 2d 775). The California Attorney General has opined that the legislative body of a local public agency must maintain control over the allotted time that is given to particular matters on its meeting agendas. ". . . A single item or several items may not unreasonably be permitted to monopolize the time necessary to consider all agenda items. (5 Ops. Cal. Atty. Gen. 89). In *White v. City of Norwalk* (9<sup>th</sup> Cir. 2990) 900 F. 2d 1421, the Court concluded that even though citizens have First Amendment Rights in presenting their views at a public agency public meeting, the meeting is still a governmental process with a governmental purpose. The Court pointed out that even though a speaker at a public meeting could not be stopped because of a disagreement with his/her views, a speaker can be prevented from continuing because the content of his/her remarks has become irrelevant or repetitious. The California Attorney General maintains that a public agency can validly set a time limit of 5 minutes or less for each item on its agenda, depending on the circumstances. According to the Attorney General, the time allocated for the meeting, the number of agenda items, the complexity of each item, and the number of persons wishing to address the legislative body on each item would require consideration in setting the time limitations. (75 Ops. Cal. Atty. Gen. 89). Such regulations on public comment must be reasonable, viewpoint neutral and not exercised in an arbitrary and capricious manner. Attachment E contains language to consider on the Public Addressing the Board.

In a recent e-mail to the Board of Directors (Attachment F), Director Pat Spence inquired whether the Board of Directors wanted to make its appointments to the SCCRTC in February rather than January of each year. Director Spence commented that because of the turnover of Board members it may enable greater participation if the appointments are made in February. To effectuate a change in the SCCRTC appointment process, the Board of Directors would need to amend Bylaws Section 14.02 (a).

Depending on the results of the discussion on the removal of Board appointments to the METRO Advisory Committee, the Board may wish to incorporate new language into the Bylaws on this issue. Rather than limit the language to MAC, the Board may wish to incorporate language regarding removal into Section 14.01.

#### IV. FINANCIAL CONSIDERATIONS

None

**V. ATTACHMENTS**

- Attachment A:** Santa Cruz METRO's Bylaws with proposed amendments
- Attachment B:** Previously adopted SCMTD Rules of Order (Director Rotkin)
- Attachment C:** Alternative methods for the nomination and selections process for representatives and alternates to the SCCRTC
- Attachment D:** Proposed Language for Public Addressing the Board
- Attachment E:** E-mail from Director Pat Spence re Appointment of METRO's SCCRTC Representatives

RESOLUTION NO. 69-2-1  
Amended 1-21-83, 6-16-89, 8-21-92,  
4-15-94, 4-21-95, 4-27-97, 9-1 8-98,  
4-16-99, 11-19-99, 6-16-00, 6-08-01,  
6-15-01, 9-21-01, 02-15-02, 06-21-02,  
09-27-02, 10-10-03, 12-19-03, 09-24-04  
On the Motion of Director:  
Duly Seconded by Director:  
Is Hereby Amended:

**A RESOLUTION OF THE  
SANTA CRUZ METROPOLITAN TRANSIT DISTRICT BOARD OF DIRECTORS  
ESTABLISHING RULES, REGULATIONS, AND PROCEDURES FOR,  
AND THE TIME AND PLACE OF MEETINGS OF THE BOARD; AND  
CREATION OF OTHER OFFICES**

**I. REGULAR MEETINGS**

**1.01 Regular Meetings; Time**

- (a) Regular meetings of the Board of Directors shall be held on the second Friday of each month from 9:00 a.m. to not later than 11:00 a.m. and on the fourth Friday of each month from 9:00 a.m. to not later than noon. The Board of Directors may extend the meeting times as necessary through Board action. Notwithstanding the foregoing, if a regular meeting falls within 5 working days of a recognized District holiday, i.e., Thanksgiving, Christmas or New Year's Day, the Board of Directors shall reschedule the meeting to a more convenient date. The regular meeting schedule shall be published for the upcoming year and approved by the Board of Directors during October of each year.
- (b) The regular meeting on the second Friday of the month shall primarily be in a workshop format to review matters that may be agendized for the Regular Board Meeting scheduled for the fourth Friday of the month. However, the Board of Directors may take action at either regular Board meeting pursuant to the agenda prepared in accordance with California law and these Bylaws.

**1.02 Regular Meetings; Place**

- (a) The Regular meeting of the Board of Directors on the second Friday of the month shall be convened in the Encinal Conference Room at Santa

Cruz Metropolitan Transit District, 370 Encinal Street, Suite 100, Santa Cruz, CA 95060. The Regular meetings of the Board of Directors on the fourth Friday of the month shall be convened in the Santa Cruz City Council Chambers, City Hall, 809 Center Street, Santa Cruz, California, except that in the following months the meetings will be held at the specified locations: May: Capitola City Council Chambers located at 420 Capitola Avenue, Capitola, California; November: Watsonville City Council Chambers located at 250 Union Street, Watsonville, California.

- (b) If, by reason of fire, flood, earthquake or other emergency, it shall be unsafe to meet in the place designated above, the meeting shall be held for the duration of the emergency or unsafe condition at the place designated by the Chair of the Board of Directors in a notice to the local media that have requested notice in writing, by the most rapid means of communication available at the time. A notification advising the public of the changed meeting location during the emergency or unsafe condition shall be posted on the door of the regular meeting room by the Secretary/General Manager, unless circumstances prevent her/him from doing so.
- (c) The Board of Directors shall not conduct any meeting in any facility that prohibits the admittance of any person, or persons, on the basis of race, religious creed, color, national origin, ancestry, sex, age, marital status, sexual orientation, veteran status, or which is inaccessible to disabled persons, or where members of the public may not be present without making a payment or purchase.

**1.03 Regular Meetings; Open to the Public**

- (a) Meetings of the Board of Directors shall be open and public and all persons shall be permitted to attend except as otherwise allowed by law or when a closed session is authorized pursuant to applicable state law and properly noticed in accordance therewith.
- (b) A Spanish-bilingual interpreter shall be present and available for translations at the Regular Board Meeting held on the fourth Friday of the month.

12B.a2

**1.04 Closed Sessions: State Reasons and Legal Authority; Scope of Coverage; Notice; Reporting Out**

- (a) Prior to holding any closed session, the Board of Directors shall disclose, in an open meeting, the item or items to be discussed in the closed session. The disclosures may take the form of a reference to the item or items as they are listed by number or letter on the agenda. In the closed session, the Board of Directors may consider only those matters covered in its statement. Nothing in this section shall require or authorize a disclosure of information prohibited by state or federal law.
- (b) After any closed session, the Board of Directors shall convene into open session prior to adjournment and shall make any disclosures required by state law of action taken in the closed session.

**II. AGENDA**

**2.01 Agenda; Notification, and Post&**

- (a) In order to facilitate the orderly conduct of the business of the Board of Directors, all reports, communications, resolutions, or other matters to be submitted to the Board of Directors shall be submitted to the Secretary/General Manager not later than 12:00 noon on the Friday two weeks prior to the date of the regular Board of Director's meeting scheduled for the second Friday of the month.
- (b) The Chair, in consultation with the Secretary/General Manager, shall arrange the agenda and shall furnish a copy of it to each member of the Board, to the District Counsel, to the County Administrative Officer, and to the City Manager of Santa Cruz, Capitola, Watsonville and Scotts Valley not later than the Tuesday in the week of a Regular Board meeting; the agenda shall be posted on the Official Bulletin Board for the public at the Administrative Office of the Santa Cruz Metropolitan Transit District at least 72 hours preceding each regular Board meeting.
- (c) The agenda shall contain a brief description of each item of business to be transacted or discussed at the meeting, including items to be discussed in closed session. The agenda shall specify the time and location of the regular meeting and shall be posted in a location that is freely accessible to members of the public.

12B.a3



**2.02 Agenda; Public Input**

Every agenda for regular open meetings shall provide an opportunity for members of the public to directly address the Board of Directors on items of interest to the public, before or during the Board's consideration of the item, that is within the subject matter jurisdiction of Santa Cruz Metropolitan Transit District, provided that no action shall be taken on any item not appearing on the agenda unless the Board complies with Section 2.03 below.

**2.03 Agenda; Action Taken Not on Agenda**

- (a) No action or discussion shall be taken on any item not appearing on the posted agenda except that members of the Board of Directors present at the meeting or District staff may briefly respond to statements made or questions posed by persons exercising their public testimony rights. In addition, on their own initiative, or in response to questions posed by the public, Directors or District staff may ask a question for clarification, make a brief announcement, or make a brief report on his or her own activities. Furthermore, a Director or the Board itself may, subject to the District's rules and regulations, provide a reference to staff or other resources for factual information, request staff to report back to the body at a subsequent meeting concerning any matter, or, take action to direct staff to place a matter of business on a future agenda.
- (b) Notwithstanding subdivision (a) above, the Board of Directors may take action on items of business not appearing on the posted agenda under any of the conditions stated below. Prior to discussing any item pursuant to this section, the Chair of the Board of Directors shall publicly identify the item.
  - (i) Upon a determination by a majority vote of the Board of Directors that an emergency situation exists, as defined in Section 4.01(b) herein;
  - (ii) Upon a determination by a two-thirds vote of the Directors present at the meeting, or, if less than two-thirds of the members present at the meeting, a unanimous vote of those member present, that there is a need to take immediate action and that the need for action came to the attention of the District subsequent to the agenda being posted; or

12B.a4

- (iii) The item was posted pursuant to a prior meeting of the Board of Directors occurring not more than five calendar days prior to the date action is taken on the item, and at the prior meeting the item was continued to the meeting at which action is being taken.

#### **2.04 Agenda; Other Distributed Writings**

- (a) Agendas and any other writings when distributed to all or a majority of all, the members of the Board of Directors by any person in connection with a matter subject to discussion or consideration at a public meeting are public records and shall be made available without delay unless the writing is exempt from disclosure pursuant to the Public Records Act.
- (b) Writings which are public records as set forth above and which are distributed during a public meeting shall be made available for public inspection at the meeting if prepared by the District or a Director or after the meeting if prepared by some other person.

### **III. SPECIAL MEETINGS**

#### **3.01 Special Meetings; Notice and Purpose**

- (a) A special meeting may be called at any time by the Chair or by a majority of the members of the Board of Directors, by delivering personally or by any other means, at least 24 hours in advance, written notice to each member of the Board of Directors, and to each local newspaper of general circulation, radio or television station requesting notice in writing. The call and written notice shall specify the time and place of the special meeting and the business to be transacted **and discussed**.
- (b) No other business shall be considered at the special meeting. The call and notice shall be posted at least 24 hours prior to the special meeting in a location that is freely accessible to members of the public.
- (c) Every notice for a special meeting at which action is proposed to be taken on an item shall provide an opportunity for members of the public to directly address the Board of Directors concerning that item prior to action on that item.
- (d) The written notice may be dispensed with by any member of the Board

12B.a5

of Directors, who at or prior to the time of the meeting convenes, files with the Secretary/General Manager a written waiver of notice. The waiver may be given by telegram. Written notice may also be dispensed with as to any member who is actually present at the meeting at the time it convenes. Notice shall be required pursuant to this section regardless of whether any action is taken at the special meeting.

#### IV. EMERGENCY MEETINGS

##### 4.01 Emergency Meetings; Notice and Purpose

- (a) In the case of an emergency situation involving matters upon which prompt action is necessary due to the disruption or threatened disruption of public facilities, the Board of Directors may hold an emergency open meeting without complying with either the 24-hour notice requirement or the 24-hour posting requirement of Section 3.01 herein.
- (b) For purposes of this section, “emergency situation” means any of the following:
  - (i) **An Emergency means a** ~~W~~work stoppage, **crippling disaster** or other activity which severely impairs public health, safety, or both, as determined by a majority of the members of the Board of Directors.
  - (ii) **A dire emergency means a** ~~&~~ripping disaster, **mass destruction, terrorist act, or threatened terrorist activity that poses peril so immediate and significant that requiring the Board of Directors to provide one-hour notice before holding an emergency meeting may endanger ~~which severely impairs~~ **the** public health, safety, or both, as determined by a majority of the members of the Board of Directors.**
- (c) Although no notice to the public is required, each local newspaper of general circulation and radio or television station which has requested notice of special meetings shall be notified by the presiding Chair of the Board of Directors, or designee thereof, one hour prior to the emergency meeting by telephone **or in the case of a dire emergency, at or near the time that the Chair or designee notifies the directors of the emergency meeting.** ~~and~~ ~~a~~All telephone numbers provided in the most recent request of such newspaper or station for notification of special meetings

12B.ab

shall be exhausted. In the event that telephone services are not functioning, the notice requirements of this section shall be deemed waived, and the Chairperson of the Board of Directors, or designee thereof, shall notify those newspapers, radio stations, or television stations of the fact of the holding of the emergency meeting, the purpose of the meeting and any action taken at the meeting as soon after the meeting as possible.

#### **4.02 Emergency Meetings; Open to the Public**

Emergency meetings are always open meetings regardless of the subject matter **except that if agreed to by a two-third vote of the Directors present or if less than two-thirds of the Directors are present, by a unanimous vote of those present, the Board of Directors may hold a closed session with the Attorney General, District Attorney, District Counsel or Chief of Police or their respective deputies, or a security consultant or a security operation manager on matters posing a threat to the security of public buildings, a threat to the security of essential public services, or a threat to the public's right of access to public service or public facilities.**

#### **4.03 Emergency Meetings; Requirements**

All special meetings requirements, as prescribed in Section 3.01 herein, shall be applicable to a meeting called pursuant to this section, with the exception of the 24-hour notice requirement.

#### **4.04 Emergency Meetings; Minutes**

The minutes of a meeting called pursuant to this section, a list of persons who the presiding chair of the Board of Directors, or its designee notified or attempted to notify, a copy of the roll call vote and any actions taken at the meeting shall be posted for a minimum of 10 days in a public place as soon after the meeting as possible.

### **V. DIRECTORS**

#### **5.01 The Board of Directors**

The District shall be governed by a Board of Directors of eleven members because such membership is necessary to insure adequate representation to all of the areas in the County of Santa Cruz.

12B.a7

### **5.02 Appointment**

The membership of the Board of Directors shall be composed of one member appointed by each City Council of Santa Cruz, Capitola, Scotts Valley, Watsonville and any other incorporated area of the District to represent the incorporated area and one member appointed by the Board of Supervisors of the County of Santa Cruz to represent the unincorporated area. Other appointments shall be made in accordance with the proportionate population within the District. The apportionment shall be based upon the population distribution within the District and the Board shall reapportion its membership whenever any part of the District is excluded or new territory is added or unincorporated territory within the District incorporates and as a result of the exclusion, annexation, or incorporation, representation on the Board no longer reflects the population distribution within the District. The Board shall also reapportion whenever the County Clerk advises the Board that the latest official census indicates a need for reapportionment.

### **5.03 Term of Office**

- (a) The term of office for each Director shall be four years.
- (b) If the appointee of any legislative body is one of its own members the appointee may serve only as long as the appointee is a member of the legislative body.
- (c) An appointment to fill a vacancy on the Board or an appointment made after the expiration of the preceding term shall be for the unexpired portion of the term.
- (d) The failure of a Board member to attend three consecutive meetings of the Board without good cause shall create **a vacancy** in the office of the Board member.

### **5.04 Directors' Code of Ethics**

A Directors' Code of Ethics is attached as Exhibit A to these Bylaws and shall serve as a guideline for the Directors in the work that they perform on behalf of the District.

### **5.05 Director Compensation**

Each Director shall receive \$50 for attendance at a meeting of the Board of Directors, attendance as a committee member at a committee meeting of the Board of Directors, attendance as a Board member at an Advisory Committee, attendance at an American Public Transit Association meeting, attendance at a California Transit Association meeting or when performing District business in lieu of attendance at any of the above-stated meetings, up to a maximum of \$100 per month.

### **5.06 District Travel And Personal Expenditures**

- (a) A District Director shall obtain Board authorization to perform or participate in District business prior to actual attendance if such involves the expenditure of District funds. A Director shall receive reimbursement for meals, transportation and other expenses incurred on behalf of the District in accordance with the District's expense list which is attached hereto as Exhibit B.
- (b) Invoices shall be submitted to the Chair of the Board of Directors for approval. After approval is obtained from the Chair the reimbursement request shall be forwarded to the Finance Department for reimbursement. Reimbursement shall not be necessary when a District staff member pays directly for a Director's expenses.
- (c) Advances based on internal revenue service rates will be made upon a director's request, however, receipts of expenditures must be provided to the Chair of the Board of Directors for approval. All advanced funds shall be returned to the Administrative Services Coordinator if the trip is cancelled or the funds are not used.
- (d) A complete report of all expenses incurred by the Director while engaging in District business shall be submitted by the Director to the Board of Directors for review. Such report may be prepared by District staff upon request.
- (e) District Directors shall not include any expenditure for spouses, friends, or others as a District expense.
- (f) The District's Administrative Services Coordinator shall schedule all conferences, hotel accommodations and transportation for a Director.

12B.a9

## VI. PRESIDING OFFICERS

### 6.01 Election

- (a) The Directors shall in December nominate members of the Board of Directors to serve as Chair and as Vice-Chair of the Board of Directors. The Board of Directors shall, at their first regular meeting in January of each year, choose one of its members to serve as Chair and one of its members to serve as Vice-Chair to serve for the balance of the calendar year or until the selection of their successors.
- (b) Should the office of Chair or Vice-Chair become vacant during the calendar year, the Board of Directors shall choose a successor to fill the vacancy for the balance of that calendar year, or until the selection of a successor.
- (b) In the event of a vacancy of both the Chair and Vice-Chair positions, the Directors shall meet in order to nominate members of the Board of Directors for the vacant positions.

### 6.02 Chair to Preside

The Chair shall preside at all meetings of the Board of Directors. The Chair shall have authority to preserve order at all meetings and to remove or cause the removal of any person from any meeting of the Board of Directors for disorderly conduct, to enforce the rules of the Board of Directors and to determine the order of business under the rules of the Board of Directors.

### 6.03 Absence of Chair

If the Chair is absent or unable to act, the Vice--Chair shall serve until the Chair returns or is able to act. The Vice-Chair has all of the powers and duties of the Chair while acting as Chair. In the absence of both the Chair and the Vice-Chair, the Directors shall nominate and elect a director to serve as chair pro tempore during such absences.

## VII. CONDUCT OF MEETING

### 7.03 Call to Order

The Chair shall at the hour appointed for the meeting, immediately call the

12B.a10

Board of Directors to order when a quorum is present. The Chair shall preserve strict decorum at all meetings. She/he shall state every question coming before the Board of Directors, call for the vote, announce the 'decisions of the Board of Directors, and decide all questions of order, subject, however, to an appeal to the Board of Directors, in which a majority vote of the Board of Directors shall govern and conclusively determine such question of order.

#### **7.02 Rights of Chair**

The Chair, or such other member of the Board as may be presiding, may second and debate, subject only to such limitation of debates as are by these rules imposed on all members; the Chair shall not be deprived of any' of the rights and privileges of a Director by reason of holding the position of Chair.

#### **7.03 Rules of Debate**

- (a) Every Director desiring to speak shall address the Chair, and upon recognition by the presiding officer, shall be confined to the question under debate, avoiding all references to personalities and indecorous language.
- (b) A Director, once recognized, shall not be interrupted when speaking unless it is to call her/him to order. If a Director, while speaking, is called to order, she/he shall cease speaking until a question of order is determined and, if in order, she/ he shall be permitted to proceed.
- (c) A Director may request, through the presiding officer, the privilege of having an abstract of her/his statement on any subject under consideration by the Board of Directors entered into the minutes. If the Board of Directors consents thereto, such statement shall be entered; provided, however, that any Director, without the Board's consent, shall have the right to have the reasons for her/his dissent from, or protest against, any action of the Board of Directors entered into the minutes.
- (d) The Secretary/General Manager may be directed by the Chair, with the consent of the Board, to enter in the minutes a synopsis of the discussion of any question coming properly before the Board of Directors.

#### **7.04 Rules of Procedure**

**Rules of Procedure, which are attached hereto as Exhibit C and incorporated herein by reference shall be followed by the Board of Directors. A complete**

12B.all



**copy of the Bylaws shall be included in each Director's Board packet and made available for members of the public at Board of Directors' meetings.**

**7.05 Disruption of Meeting; Clearing Room**

In the event that any meeting is willfully interrupted by a group or groups of persons so as to render the orderly conduct of such meeting unfeasible and order cannot be restored by the removal of individuals who are willfully interrupting the meeting, the members of the Board of Directors conducting the meeting may order the meeting room cleared and continue in session. Only matters appearing on the agenda may be considered in such a session. Representatives of the press or other news media, except those participating in the disturbance, shall be allowed to attend any session held pursuant to this section. In order to readmit individuals who were not disruptive, the following procedure shall be used:

- (a) When a meeting is disrupted to the point that it cannot be continued, the Chair shall order those persons causing the disruption to leave the meeting.
- (b) If those causing the disruption fail or refuse to leave the meeting, the Chair shall recess the meeting, order the meeting room cleared and summon law enforcement.
- (c) Upon the arrival of law enforcement, the Chair shall reconvene the meeting.
- (d) District Staff shall be directed to readmit those members of the public who did not engage in the disorderly conduct on an individual and intermittent basis.
- (e) If the meeting is again disrupted, the Chair shall cause the meeting room to be cleared and the meeting will continue with only the press in attendance if they have not engaged in any disruption.

**VIII. QUORUM**

**8.01 Transaction of Business; Quorum**

A six member majority of the regular members of the Board of Directors shall constitute a quorum for the transaction of business.

12B.912

## IX. ADJOURNMENT/CONTINUANCES

### 9.01 Adjournment of Meeting

- (a) The Board of Directors may adjourn any regular, adjourned regular, special or adjourned special meeting to a time and place specified in the order of adjournment.
- (b) Less than a quorum may adjourn any meeting.
- (c) In the absence of all Directors from any meeting, the Secretary/General Manager may declare the meeting adjourned to a stated day and hour. If she/he does, she/he shall then cause written notice of the adjournment to be given in the same manner as provided for Special Meetings set forth herein.
- (d) A copy of the order or notice of adjournment shall be conspicuously posted on or near the door of the place where the regularly adjourned regular, special, or adjourned special meeting was held within 24 hours after the time of adjournment.
- (e) When a regular or adjourned regular meeting is adjourned as provided herein, the resulting adjourned meeting is a regular meeting for all purposes.
- (f) When an order of adjournment of any meeting fails to state the hour that the adjourned meeting is to be held, it shall be held at the hour specified for regular meetings of the Board of Directors.
- (g) Any hearing being held, or noticed or ordered to be held, by the Board of Directors at any meeting may by order or notice of continuance be continued or recontinued to any subsequent meeting of the Board of Directors in the same manner and to the same extent set forth above for the adjournment of meetings; provided that, if the hearing is continued to a time less than 24 hours after the time specified in the order or notice of hearing, a copy of the order or notice of continuance of hearing shall be posted immediately following the meeting at which the order or declaration of continuance was adopted or made.

## **X. MINUTES**

### **10.01 Minute-Book Record of Open Sessions**

- (a) The Secretary/General Manager, or her/his designee, shall attend all open meetings of the Board of Directors and record and maintain a full and true record of all of the proceedings of the Board of Directors in books that shall bear appropriate titles and be devoted to such purpose. Such books shall have a general index sufficiently comprehensive to enable a person readily to ascertain matters contained therein.
- (b) Unless reading of the minutes of a Board of Directors meeting is requested by the Board of Directors by a majority vote, such minutes may be approved without reading if the Secretary/General Manager has previously furnished each member with a synopsis thereof.

### **10.02 Minute Book Record of Closed Sessions**

The Secretary/General Manager shall attend each closed session of the Board of Directors unless otherwise directed by the Board of Directors and shall keep and enter in a minute book a record of topics discussed and decisions made at the meeting. The closed session minute book is not a public record and shall be kept confidential. This minute book shall be available only to members of the Board of Directors of Santa Cruz Metropolitan Transit District or, if a violation of the Ralph M. Brown Act is alleged to have occurred at a closed session, to a court of general jurisdiction.

### **10.03 Protests and Dissents by Directors Entered in Minutes**

Any Director shall have the right to have the reasons for the Director's dissent from, or protest against any action of the Board entered in the minutes.

## **XI. PUBLIC'S ROLE IN MEETINGS/PUBLIC HEARINGS**

### **11.01 Public Addressing the Board**

Each person addressing the Board may but is not required to give his/her name and shall speak in an audible tone of voice for the record, and unless further time is granted by the Board, shall limit his/her address to five minutes; if more than five people wish to address the Board of Directors on any one issues, each individual shall be limited to three minutes. All remarks shall be addressed to

12B.a14

the Board of Directors as a body and not to any member thereof. No person, other than the Chair and the person having the floor, shall be permitted to enter into any discussion, either directly or through a member of the Board, without permission of the Chair. No question shall be asked of a Board member except through the Chair. Additionally, any person may submit written materials to the Board of Directors for its consideration.

#### 11.02 Public Hearings

- a) Requests for public hearings shall be in writing and shall be submitted to the Administrative Services Coordinator no later than five (5) days before the last day permitted for announcing the public hearing. All public hearings shall be noticed in local newspaper(s) of general circulation by the Administrative Services Coordinator at the direction of the Secretary/General Manager.
- b) The department manager requesting the public hearing shall investigate all applicable requirements for posting of public hearing notices and shall communicate such requests to the Administrative Services Coordinator to ensure that all public hearings are noticed sufficiently in advance of the date of consideration by the Board of Directors.
- c) A public hearing will be held before the Board of Directors when required by federal, state, or local laws or regulations or when it is asked to take action on any of the following projects:
  - (i) A change in 25% or more to the service mileage of any route.
  - (ii) A change in District fares.
  - (iii) Adoption of a Resolution authorizing application for federal funds, state or local funds when required by the funding source.
  - (iv) Adoption of any action taken relating to the adoption of any plan, environmental document, property acquisition, resolution, condemnation resolution or other action relating to a project or property where such public hearing is required by state, federal or local law.
  - (v) Adoption of the Annual Budget.
  - (vi) Adoption of the Short Range Transit Plan.
  - (vii) Adoption of an Ordinance.

## **XII. RESOLUTIONS, ORDINANCES AND MOTIONS**

### **'12.01 Acts of Board**

The acts of the Board of Directors shall be expressed by Motion, Resolution or Ordinance. No Ordinance, Resolution or Motion shall have any validity or effect unless passed by the affirmative votes of six directors. The Board of Directors shall not take action by secret ballot, whether preliminary or final in an open or closed session.

### **12.02 Resolution**

No resolution shall be adopted by the Board unless it is presented before the Board in writing or read aloud. Where copies of the resolution have been presented to each Director, the reading of the resolution is automatically waived unless a Director specifically requests that it be read. Resolutions must be adopted by a roll call vote; however, routine resolutions may be placed on the consent agenda. In the event that a Director wishes to dissent or abstain, the resolution will be removed from the consent agenda and be placed on the Regular Agenda. Resolutions may also be passed by unanimous voice vote.

### **12.03 Ordinance**

- (a) No ordinance shall be passed until a public hearing has been held on it, which hearing shall be advertised in a newspaper of general circulation or posted in at least three public places at least 15 days prior to the hearing. No ordinance shall be adopted by the Board of Directors on the day of introduction. Ordinances must be adopted by a roll call vote.
- (b) All ordinances shall be printed after passage, and maintained in the District Administrative Offices.
- (c) The enacting clause of all ordinances shall be as follows:  
  
"Be it enacted by the Board of Directors of the Santa Cruz Metropolitan Transit District:..."
- (d) All ordinances shall be signed by the Chair of the Board or Vice-Chair and attested by the Secretary/General Manager.

12B.a16

### **XIII. METHOD OF VOTING**

#### **13.01 Voice Vote**

Unless a roll call vote is specifically requested by a Director, all matters, except the voting on Resolutions and Ordinances, shall be decided by voice vote. All actions of the Board of Directors shall be approved by affirmative vote of a minimum of six voting members of the Board of Directors unless otherwise specifically required.

#### **13.02 Silence Recorded as Affirmative Vote**

A member's silence shall be recorded as an affirmative vote.

#### **13.03 Duty to Vote**

Each Director has a duty to vote when present at a meeting on matters coming before the Board of Directors or a Board Committee unless he/she has notified the Board of Directors of a legal conflict of interest in accordance with California state law and has made a full public disclosure regarding such conflict of interest. If a conflict of interest is disclosed, the Director shall abstain from voting, unless otherwise required by law to vote.

#### **13.04 Unanimous Voice Votes in Lieu of Roll Call for Resolutions**

A Director can move the passage of a Resolution by a unanimous voice vote in lieu of a roll call. If a dissent is registered then a roll call vote shall be taken.

### **XIV. COMMITTEES AND APPOINTMENTS**

#### **14.01 Creation-of Committees**

The Board of Directors may establish committees for a stated purpose. **If required by California Law,** All-committees and their members shall comply with the Ralph M. Brown Open Meeting Act, ~~and~~ Committees are required to comply with these Rules and Regulations. The Secretary/General Manager shall provide adequate staffing to assist the committees in doing their work. Directors who are not committee members may attend committee meetings as long as they attend only as observers when a majority of the Board of Directors is in attendance at the committee meeting. The committees shall include the following:

12B.a17

- (a) Working committees or subcommittees of the Board of Directors analyze, review, and make recommendations to the Board of Directors on items to be presented to the full Board. The Chair of the Board shall appoint members of the Board to such committees or subcommittees and shall also appoint a Board member to chair the committees or subcommittees. If a vacancy occurs, the Board Chair shall appoint a Director to fill the vacancy. Minutes shall be taken at each committee and shall be prepared and distributed to the Directors at least two days prior to the regular Board meeting.

The Board of Directors may from time to time create advisory committees who shall be charged with giving advice to the Board of Directors regarding an issue relevant to the Transit District's business. Appointments to advisory committees may be made by the Chair, or the Board of Directors. Directors, employees or members of the public may sit on an advisory committee. The following are permanent advisory committees of the Board of Directors:

- (i) Metro Advisory Committee (MAC)

- (a) The Metro Advisory Committee (MAC) is the official advisory committee of the Santa Cruz Metropolitan Transit District: Its purpose is to ~~provide~~ **advise** ~~to~~ the Board of Directors on matters of METRO policy and operations referred to the committee by the Board or the Secretary/General Manager and to perform such additional duties as assigned. **The committee may also address issues which committee members or the public raise with respect to the quantity and quality of services provided by METRO.**
- (b) MAC shall be composed of 11 members appointed by the Board of Directors. Each director shall nominate one individual to serve as members of the MAC.
- (c) The Board of Directors shall approve bylaws to be followed by MAC.

- (ii) Metro Accessible Services Transit Forum (MASTF)

- (a) The Metro Accessible Services Transit Forum (MASTF) is an independent volunteer organization that **provides advice** ~~advises~~ to the Santa Cruz Metropolitan Transit District Board of Directors and District management and staff regarding the best methods and resources for providing accessible transportation services to the public. MASTF reviews Metro programs for compliance with §504 of the Vocational Rehabilitation Act of 1973, Americans with Disabilities Act

12B.a18

of 1990 and all other appropriate local, state and federal laws and regulations.

- (b) The District shall regularly send one staff member to the MASTF meetings and this person shall share information from the District and gather concerns from MASTF. The District shall help in the preparation and distribution of meeting notices and agendas. Information on MASTF will remain in the Headways publication.

#### **14.02 Appointment to Santa Cruz County Regional Transportation Commission**

- a) **The Board of Directors shall each year in January appoint three representatives and three alternates (in order of priority) to the Santa Cruz County Regional Transportation Commission (SCCRTC) who must be members of the Board of Directors. The Board Chair shall submit nominations of three representatives and three alternates for the first Board meeting in January. At that first meeting in January, the Chair shall entertain other nominations for SCCRTC representatives and alternates from the Directors. Thereafter at the second meeting in January, the Board of Directors shall vote on the nominations via a motion and a second. To be appointed a nomination shall receive at least six affirmative votes. A Director may move a slate of three representatives or a slate of three alternates for appointment. If none of the previously nominated directors receive the appointments, then the Chair shall entertain further nominations from the Directors until such time as three representatives and three alternates are approved by the Board of Directors.**
- b) The Board of Directors may provide its SCCRTC transportation -W-representatives with guidance on issues coming before the Commission to assist the director/commissioner in serving the best interests of **the** Transit District.

### **XV. OFFICIAL BULLETIN BOARD**

#### **15.01 Posting of Notices**

For purposes of posting official notices of the Board of Directors, notices of public hearings, and any other official papers of the **Santa** Cruz Metropolitan Transit District where posting is required by the law, the Official Bulletin Board of the Santa Cruz Metropolitan Transit District **shall** be the bulletin board at the entrance of the District Administrative Office. Should **the** Board of Directors

12B.919



hold a public hearing at any location other than its regular place of meeting, then, in addition to the posting of the notice on the Official Bulletin Board above listed, posting shall also be made upon or near the door of the place of meeting.

15.02 All advisory committees created by the Board of Directors are required to post any and all official notices including those notices required by law at the official bulletin board so designated for that purpose at the Santa Cruz Metro Center, 920 Pacific Avenue, Santa Cruz, CA 95060.

## **XVI. OTHER OFFICES**

### **16.01 General Manager; Powers and Duties**

In addition to the powers, duties and obligations of the General Manager, as set forth above, and the applicable Public Utilities Code pertaining to the Santa Cruz Metropolitan Transit District, the powers and duties of the General Manager shall include the following:

- (a) To have charge, subject to the direction and control of the Board of Directors, of the acquisition, construction, maintenance, and operation of the facilities of the District.
- (b) To have charge, subject to the direction and control of the Board of Directors, of the administration of the business affairs of the District.
- (c) To insure that all ordinances of the District are enforced
- (d) To administer the personnel system and collective bargaining agreements adopted by the Board of Directors and, except for officers appointed by the Board, to appoint, discipline or remove all officers and employees subject to the rules and regulations adopted by the Board, and the applicable provisions of any adopted collective bargaining agreement.
- (e) To prepare and submit or cause to be prepared and submitted to the Board of Directors within 90 days after the end of each fiscal year a complete report of the finances and the administrative activities of the District for the preceding year, and the financial status of the District on the last day thereof.
- (f) To keep the Board of Directors advised as to the needs of the District.

12B.a20

- (g) To formulate and present to the Board of Directors all plans and specifications for the construction of the works of the District and the means to finance them.
- (h) To have no business interest which interferes with his/her duties and responsibilities to the District.
- (i) To cause to be installed and maintained a system of auditing and accounting which shall completely and at all times show the financial condition of the District.
- (j) Attend meetings of the Board of Directors as directed by the Board, and act as Secretary to the Board.
- (k) To perform such other and additional duties as the Board may require.

**16.02 General Manager; Qualifications and Experience**

The General Manager shall be chosen on the basis of his/her qualifications with special reference to his/her actual experience in or knowledge of accepted practices and respect to the duties of his/her office as herein above set forth.

**16.03 General Manager; Pro Tempore Appointments**

The Board of Directors may appoint a General Manager pro tempore during any absence or disability of the General Manager.

**16.04 General Manager; Resident Requirement**

The General Manager need not be a resident of this State at the time of his/her appointment, however /he/she shall establish a California residency within 30 days of the commencement of his or her duties with the Transit District.

**16.05 District Counsel; Appointment, Powers and Duties**

The District Counsel shall be admitted to the practice of law in all courts of this State. The District Counsel shall have the power and be required to:

- (a) Represent and advise, if authorized and directed by the Board of Directors, the Board of Directors and all District officers, committees or

12B.a21

- departments in all matters pertaining to their office.
- (b) Represent and appear, if authorized and directed by the Board of Directors, for the District and any officer or employee, in any and all actions and proceedings in which the District or any officer or employee, in or by reason of their official capacity, is concerned or is a party; however, the Board of Directors shall have control of all legal business and proceedings and may employ other attorneys to take charge of any litigation or matter, or to assist the District Counsel therein.
  - (c) Attend all meetings of the Board of Directors as directed by the Board of Directors and give legal advice or opinions in writing whenever requested to do so by the Board of Directors, or by any of the committees or officers of the District.
  - (d) Review all contracts to be made by the District and provide the Board of Directors, its officers and staff with legal advice regarding same.
  - (e) Prepare any and all proposed ordinances or resolutions for the District and amendments thereto.
  - (f) Perform such other acts relating to the office as the Board of Directors shall require; and
  - (g) On vacating the office, surrender all books, papers, files, and documents pertaining to the District's affairs.

**PASSED AND ADOPTED** this 24th day of September 2004, by the following vote:

**AYES:** Directors -

**NOES:** Directors -

**ABSTAIN:** Directors -

**ABSENT:** Directors -

**APPROVED** \_\_\_\_\_

EMILY REILLY  
Chairperson

**A T T**       **E S T**        
LESLIE R. WHITE  
General Manager

12B.a22

**APPROVED AS TO FORM:**

---

MARGARET GALLAGHER, District Counsel

12B.923

Effective Date: April 16, 1999

Pages: 5

**TITLE: Santa Cruz Metropolitan Transit District Director's Code of Ethics**

| REVISION DATE  | SUMMARY OF REVISION | APPROVED  |
|----------------|---------------------|-----------|
| April 16, 1999 | Policy Implemented  | <i>JB</i> |

**I. POLICY**

**1.01** District Directors are public servants and, as such, are expected to be impartial and responsible in fulfilling the public trust placed in them. The public expects the highest standard of ethical conduct from all those in public service. District Directors are expected to demonstrate personal integrity, honesty, and truthfulness in all their public activities in order to inspire public confidence and trust in the District.

**II. APPLICABILITY**

2.01 This policy is applicable to all District Directors.

2.02 Notwithstanding any provision of this Code every District Director shall comply with applicable Federal, State and local laws.

**III. RESPONSIBILITIES OF PUBLIC SERVICE**

**3.01** District Directors are bound to discharge faithfully the duties of their offices, recognizing that the lives, safety, health, and welfare of the general public must be their primary concern. Their conduct in their official and private affairs should be above reproach to assure that their public office is not used for personal gain.

12B.a24

#### IV. CONFLICT OF INTEREST

4.01 District Directors are prohibited from making, participating in, or in any way attempting to use their District offices to influence a District decision in which they know or have reason to know they have a financial interest.

4.02 District Directors shall not engage in outside employment, activities, or enterprises for compensation that are inconsistent with, incompatible to, or in conflict with their duties as District Directors. The outside employment, activities or enterprises inconsistent with, incompatible to, or in conflict with an Director's District duties include those which:

- (1) involve the use for private gain or advantage of (a) a Director's District work, District facilities, District equipment and District supplies; or (b) the influence or prestige of his or her position with the District; or
- (2) involve receipt or acceptance by a District Director of any money or other consideration from anyone other than the District for the performance of an act which the Director would be required or expected to render in the regular course of his or her District obligations as a Director; or
- (3) involve the performance of an act in other than his or her capacity as a District Director which act may later be subject directly or indirectly to control, inspection, review, audit, or enforcement by the District.

4.03 No District Director shall solicit or accept gratuities, favors or anything of monetary value including personal loans, from contractors, subcontractors, consultants, potential contractors, potential consultants, or potential subcontractors, except an unsolicited gift of nominal intrinsic value. "Nominal intrinsic value" for purposes of this section shall mean a value of less than \$250, within a twelve-month period from a single source.

4.04 No current or former District Director shall disclose, permit disclosure or otherwise use confidential information acquired by virtue of his or her position with the District for his or her or another person's private gain or for any purpose except in the performance of his/her official duties and responsibilities for the District or as may be required by law. No District Director shall reveal information received in a lawful closed session of the District's Board of Directors unless such information is required by law to

be disclosed. No District Director shall take any action or provide any information for or on behalf of any prospective contractor or vendor that interferes with free and open competition for District contracts.

- 4.05 No District Director shall engage in or permit the unauthorized use of District-owned property, including but not limited to facilities, vehicles, materials, equipment, licensed software and information. Use of District property for purposes other than District business shall be considered an unauthorized use unless a Director has received prior approval for such use by the Board of Directors. Use of District property for non-District business will only be authorized when the Board of Directors determines it is in the best interest of the District to do so.
- 4.06 District Directors shall immediately report to the Board of Directors the existence of a conflict of interest, including a financial interest in making or participating in making of any governmental decision, so that appropriate action be taken.

## **V. POLITICAL ACTIVITY**

- 5.01 Except as herein otherwise provided, or as necessary to meet requirements of federal or state law, no restriction shall be placed on the political activities of any District Director.
- 5.02 No District Director who holds, or who is seeking election or appointment to, any office or employment in a state or local agency shall, directly or indirectly, use, promise, threaten or attempt to use any office, authority, or influence, whether then possessed or merely anticipated, to confer upon or secure for any person, or to aid, obstruct, or to prevent any person from securing, any position, nomination, confirmation, promotion, or change in compensation or position within the District.
- 5.03 No District Director shall directly or indirectly solicit a political contribution from a District employee, except if such solicitation is part of a solicitation made to a significant segment of the public, which may include District employees.
- 5.04 No District Director who holds, or is seeking election or appointment to, any office shall offer or arrange for any increase in compensation or salary for a District employee in exchange for, or promise of, a contribution or loan for the person who holds, or who is seeking election or appointment to

such office.

5.05 No District Director shall engage in political activity while acting in his/ her capacity as a Director for the District.

## **VI. NONDISCRIMINATION**

6.01 District, Directors shall not, in the performance of their District responsibilities, engage in unlawful discrimination of any sort under any applicable federal, state, county or municipal law or ordinance, including without limitation discrimination against any person on the basis of race, sex, color, national origin, religion, disability, age, marital status, sexual orientation, or veteran status, and they shall make good faith efforts to support and comply with the District's equal opportunity and affirmative action goals and objectives.

## **VII. STATEMENTS OF ECONOMIC INTEREST**

7.01 Directors shall file assuming office statements, annual statements and leaving office statements of economic interests with the District as required by state law. Assuming office statements for Directors shall include disclosure of investments and interests in real property and business but also income, gifts and loans income received during the 12 months prior to the date of assuming office. Upon receipt of these statements the District shall make and retain a copy and forward the original of these statements to the appropriate public agency.

## **VIII. REPORTING OF IMPROPER GOVERNMENT ACTIVITIES**

8.01 District Directors are encouraged to serve the public interest by disclosing to the Board of Directors to the extent not in conflict with the attorney-client privilege or the physician-patient privilege, information concerning District activities where the Director has reasonable cause to believe that the information discloses a violation of state or federal statute, or violation or noncompliance with state or federal regulation. No Director of the District shall use or attempt to use his or her authority to interfere with such disclosure made by another Director or a District employee or to retaliate against a Director or District employee for such disclosure.



## Santa Cruz Metropolitan Transit District Expense List

| Authorized  |
|---|
| <b>Transportation:</b>  |
| Airporter (e.g. shuttle)  |
| Bridge tolls  |
| Cab (to/from hotel)   |
| Cab (to/from meetings & meals)  |
| Parking at airport  |
| Parking at hotel, conference center                                     |
| Personal vehicle mileage to/from airport                                |
| Public transportation (e.g. bus, subway)                                |
| Rental Car with prior approval by General Manager                       |
| Transportation tickets (e.g. airline, train)                            |
| <b>Meals:</b>   |
| Coffee break expenses   |
| Meal beverages (non-alcoholic)  |
| Reasonable cost meals for self  |
| Tips for meals (15% maximum)  |
| <b>Personal Sundries:</b>   |
| Daily newspaper   |
| Personal telephone calls (reasonable and customary, <b>one</b> per day) |
| Required seminar materials  |
| Telephone calls (SCMTD business)  |
| Traveler's check fee on travel advance                                  |
| <b>Lodging:</b>   |
| Self  |
| Not Authorized  |
| <b>Transportation:</b>  |
| Baggage Claims  |
| Cab (personal)  |
| Tips to cabs  |
| Tips for luggage handling   |
| <b>Meals:</b>   |
| Bar expenses  |
| Meals for others (e.g. spouses, personal guests)                        |
| Meals upon return to Santa Cruz County                                  |
| Snacks  |
| Meals prior to departure  |
| <b>Personal Sundries:</b>   |
| Housekeeping tips   |
| Clothes cleaning  |
| Clothing  |
| Entertainment (e.g. in room pay per view, movies, video rentals)        |
| Hair care   |
| Personal items (e.g. toothpaste)  |
| Shoeshine   |
| Souvenirs/Gifts   |
| Trip Insurance  |
| <b>Lodging:</b>   |
| Other than self (e.g. spouse, personal guests)                          |

## SCMTD Board Rules of Order

First, please **note** that these suggested rules are a modification of Robert's Rules of Order. A strict following of Robert's Rules of Order is incredibly cumbersome and inefficient for a small group. The Board needs to use common sense in the application of these rules and may adopt additional modifications as problems become apparent. Nothing in formal rules can substitute for the need to have people stick to the subject at hand, not talk longer than necessary and try to cooperate in moving an agenda forward rather than deliberately use procedural rules to gum things up. That said, here are **the** basic rules:

1. Each meeting shall have an agenda which shall be made available, along with supporting materials, to the Board members and interested members of the public at least 72 hours before each meeting. The first item of business on each agenda shall be an opportunity to accept or change an agenda. The order of items may be changed and items may be deleted for lack of sufficient information to act on them. Items may not be added to an agenda without a 2/3 vote and a finding that there is either a serious emergency or that the item is urgent and only came to the attention of the body after the agenda deadline (which requires public posting a minimum of 72 hours before the meeting) had passed. The Chair, with the support of the SCMTD staff, shall establish the order for agenda items and the order should not be changed capriciously. The agenda should distinguish between items which are purely informational and items which will require action by the Board.

2. When the Board moves to an item for discussion, the Chair or the appropriate staff person usually introduces it, or some other member if that is more appropriate. Whenever possible, items will be introduced with a written recommendation for action. At any time any member other than the Chair may, after being recognized by the Chair, make a motion for action on the item. In many cases, some discussion should take place before a motion is made **so that** the motion adequately addresses the concerns of everyone present, or at least a majority of the Board.

3. It is not helpful to make motions which clearly have little support from the majority of the Board, since they are likely to be defeated and discussion of them is really a diversion. (Note that sometimes, individuals may have a political reason for introducing a motion that they know will fail just to get everyone's vote on the matter on the record, but this should be used sparingly and only on matters of importance, since it is inefficient and does not move the Board toward resolution.) Motions must be seconded for discussion. The lack of a second kills a motion and returns the Board to general discussion or a new motion. The Chair may not make motions but may second them.

4. One of the major responsibilities of the Chair is to move the Board to complete action on an agenda item. If the discussion seems to be going in circles, people are repeating themselves, etc., the Chair may suggest that it is, perhaps, time for a motion to resolve a discussion. Although the Chair may not make motions, he or she may suggest the content of a motion which other members may act on or not as they see fit.

The Chair really runs the meetings. He or she should generally defer to other members, saving comments (other than a brief introduction of an item) for last. Good chairs do manage to get input into a discussion, but their major responsibility is making the meeting run efficiently, calling on people in an even-handed fashion, encouraging people to make their comments brief and to the point, cutting people off when they are really going on too long. All of this must be done politely but firmly when necessary. Good chairing requires having a good sense of what the majority of the Board seems to want in terms of knowing when to cut off debate, encourage more debate, or ask a person to clarify a comment or a motion. The Board should respect its Chair and generally follow his or her advice. When it is clear that a ruling of the Chair does not reflect the majority of the Board's feelings, a motion may be made to overturn a Chair's ruling. This should be done infrequently. If it starts to happen frequently, it is time to think about electing a new Chair.

6. Once a motion is made and seconded, it is usually discussed (unless it is so obviously wonderful that everyone is just prepared to vote on it). Motions may be debated and they may be amended. An amendment must be an attempt to improve a motion. The chair may rule an amendment out of order if it completely undoes the intent of the main motion. (For example, a motion to add the word "not" in front of some proposed action is not acceptable.) The Board may only discuss one amendment at a time. If people don't like the amendment, they may speak against it and vote it down, but they may not amend an amendment. The following are procedures on amendments and motions:

a) The Chair may allow "friendly amendments" in which, if both the maker and seconder of the main motion like an amendment, they may just accept it into the main motion without a separate vote or further discussion. Friendly amendments should not be used as a means of cutting off debate when one or more members strongly oppose an amendment. When in doubt, or if the proposed amendment is highly controversial, the Chair should not allow an amendment to be accepted as "friendly," but should allow the members a chance to vote it up or down.

b) If in discussion of an amendment or a motion it becomes clear that everyone, including the maker and the seconder of the amendment or motion, change their minds and no longer think their amendment or motion makes much sense or believe that a different amendment or motion would be better, they may withdraw the original amendment or motion. Then, any member except the Chair may be recognized and make a different amendment or motion. A huge amount of time can be saved by having the maker and seconder of an amendment or motion recognize that someone else has a better idea, agree to withdraw their amendment or motion, and move the alternative that has been suggested and seems to have general member support.

c) A main motion may be amended as many times as the Board likes but once an amendment is made and seconded, that amendment must be discussed and either passed, rejected, or dropped by the maker and second before moving on to additional amendments or back to discussion on the main motion.

12B.b2

d) After the Board is finished amending a motion, the Board returns to the main motion for any brief final comments and then acts on the main motion. As a courtesy, a main motion may be “divided” into parts if Board members want to indicate their rejection of parts of the motion. But the Chair must be sure that “dividing the question” does not result in an absurdity; for example, allowing Board members to vote in support of the spending half of a motion without also voting for the part of the action that pays for the spending (e.g.. a member votes that they support adding a bus route, but vote against appropriating the funds for the route).

e) After everyone who wants to speak to an amendment or motion has had his or her turn, any member who has been recognized may “call the question” which is a call for a vote on the amendment or motion on the floor. Unlike the formal Robert’s Rules of Order, the Chair should either call the question or explain that they will allow a few more comments. As suggested above, the Board should respect the Chair in this matter. Board members should avoid calling the question simply out of impatience, and members should seek to avoid being redundant in their comments. As in all procedures, the Board has the right to overturn the Chair on the matter of calling the question, either insisting on more discussion or cutting debate off, but this should be used sparingly. A motion to overturn the Chair on any matter should either be taken without discussion or after only a brief comment from the Chair and the maker of the motion to overturn as to their reasons. Long debates about overturning rulings of the Chair are not productive and should be avoided at all costs. A Chair whose rulings are regularly overturned should seriously consider stepping down.

f) As with amendments, main motions may only be discussed one at a time. If members think they have a better motion than the one on the floor, they may say so, argue to defeat the motion on the floor and then if they succeed, offer their alternative. But action on the motion on the floor must be completed before moving on to another motion. (Unlike Robert’s Rules of Order, “substitute motions” should not be accepted until the motion on the floor is defeated.)

g) An amendment, a motion, or even a whole discussion item may be “**tabled.**” To table a motion is to cut off debate. Reasons for doing this might include becoming aware that there is insufficient information for action, that no position seems capable of getting a majority of support, or that the discussion is just bogging down and appears not capable of being rescued at the current meeting. An item may be tabled to a specific time (in which case the time to which is being tabled is debatable, e.g. an argument that a different date would serve the Board better) or an item may be tabled indefinitely. The latter is not debatable. As soon as it is made and seconded it must be voted up or down. An item that is tabled may be re-agendized for a later meeting, but may not be brought up again during the meeting at which it is tabled. Tabling motions should be used sparingly. Confusing and unproductive discussion may be tabled. Bad ideas should generally not be tabled but voted down after a reasonable period of debate.

7. In discussion of an item, a motion, or an amendment there is a hierarchy or priority for recognition of speakers by the Chair. Generally, attempts to be fair, inclusive, and

12B.63

efficient are guiding principles. The Chair may decide on which order to call upon speakers. The following may be helpful hints:

a) Call first on people who have not spoken yet or spoken as much as others (rather than simply who shot their hand in the air first).

b) Generally, the Chair calls upon her or himself last.

c) The highest priority for recognition is called **“a point of personal privilege.”** If a member has been personally insulted or attacked, they should have an immediate opportunity to respond. This should be used very sparingly, and never abused as a cover to make some substantive point, since a person that abuses this right may lose it. If members of the Board are regularly insulting each other, the Chair should try and resolve the issue either immediately or outside of the meeting.

d) The next highest priority for recognition is a process comment or **“point of order.”** Again, this should never be used to slip in a substantive argument, but to clarify a confusing process. For example, if someone starts to make a second amendment to a motion when a prior one is still on the floor, a process comment would be to interrupt the substantive discussion to point out the problem to the Chair. Or an observation that the meeting is running way over time and a solution needs to be found before continuing with substantive discussion of issues would take priority over someone wanting to make another point in the debate.

e) Generally, it's a good idea to start discussion of an item by asking if there are questions before entering into debates, making motions, etc. So a Chair might begin an item by asking if there are any questions and then taking comments and accepting motions. Again, members should refrain from using the question period to slip in substantive comments. Do note, however, that sometimes starting a discussion with a suggested motion clarifies things even better than questions. Members of the Board making motions early in a discussion have a real responsibility to not lead the group down unproductive paths by making motions that have no hope of passing.

8. The Chair must decide when to accept public input on an item and to what extent they need to limit either the total time for comments or the time allowed each member of the public for comment. Sometimes it is best to take public comments right after the agenda item is described. Other times it makes more sense to wait until the issue is clear, at least after some initial debate among members. Sometimes, it even makes sense to wait until there is a motion on the floor, so the public really understands what they are commenting upon. The Chair may, again, be overruled about public input, but this should be done sparingly and only for very good reason.

Finally, please remember that no formal rules can substitute for Board members coming prepared to meetings, having a clear agenda with sufficient information for good decision making, and having members who make their best effort to be cooperative with the Chair and each other, listen to each others' points, who are willing to be flexible about positions, and who attempt to make decisions efficiently, even when they disagree with

12B.64

the outcome. Good participation and full input from members and the public is very important in good decision making, but getting through agendas --getting real things accomplished, making difficult decisions and then moving on -- is equally important. Democracy suffers when groups are overly closed or dictatorial, but it also suffers when people get the perception that the SCMTD is so inefficient that it just doesn't get things done. The Board and its Chair should strive for a balance that respects full input from all participants, but also moves to action in a reasonably efficient manner.

12B.65

## Attachment C Various Alternative Methods for the Selection of METRO's SCCRTC Representatives

### **1. Board Chair Appoints Committee to Nominate Slates of Representatives and Alternates**

The Board of Directors shall each year in January appoint **its** three representatives and three alternates (in order of priority) to the Santa Cruz County Regional Transportation Commission (SCCRTC). The Board Chair shall appoint a 3-member committee **of** Directors who shall nominate three representatives and three alternates to be submitted to the Board **of** Directors at its first meeting in January. **Nominations for representatives and alternates shall also be received by the Chair from other Directors.** Thereafter, at the second meeting in January, the Board of Directors shall vote on the nominations via a motion and a second. To be appointed, a nomination shall receive **at least** six affirmative votes. A Director may move a slate of three representatives and/or a slate of alternates for appointment. If none of the previously nominated directors receive the appointments, then the Chair shall entertain further nomination from the Directors until such time as the Board of Directors approves three representatives and three alternates.

### **2. Individual Directors Nominate Slates of Representatives and Alternates**

The Board of Directors shall each year in January appoint its three representatives and three alternates (in order of priority) to the Santa Cruz County Regional Transportation Commission (SCCRTC). At the first meeting in January, the Board Chair will accept nominations from any Director of representatives and/or nominations of alternates. Each nomination must include a slate of three nominations. Thereafter, at the second meeting in January, the Board of Directors shall vote on the nominated slates via a motion and a second. To be appointed, a nominated slate shall receive at least six affirmative votes. If none of the previously nominated slates receive the appointments, then the Chair shall entertain further nomination from the Directors until such time as a slate of representatives and a slate of alternates has been approved by the Board of Directors.

**11.01 Public Addressing the Board**

- a. Every agenda for regular meetings shall provide an opportunity for members of the public to directly address the Board of Directors on any item of interest to the public, before or during the Board's consideration of the item, that is within the subject matter jurisdiction of District. Every notice for a special meeting shall provide an opportunity for members of the public to directly address the Board of Director's concerning any item that has been described in the notice for the meeting before or during consideration of that item.
- b. **The Chair of the Board of Directors may, depending on the circumstances, limit the total amount of time allocated for public testimony on particular issues and/or for each individual speaker. However, any restrictions placed on public testimony must be reasonable and not an effort to suppress expression merely because of the content of the speaker's view.**
- c. All remarks shall be addressed to the Board of Directors as a body and not to any member thereof. No person, other than the Chair and the person having the floor, shall be permitted to enter into any discussion, either directly or through a member of the Board, without permission of the Chair. No question shall be asked of a Board member except through the Chair. Additionally, any person may submit written materials to the Board of Directors for its consideration.



July 15, 2004

# Attachment E

TO: Board of Directors  
FROM: Pat Spence

Re: 7/23/04 agenda item 14 Consideration of Modification to Santa Cruz Metro's Bylaws.

The following is submitted for consideration of term expirations, the November elections and the importance to sustain time sensitive Metro projects such as Metrobase and in-house paratransit. Each jurisdiction has maybe 3 to 4 seats up for election. The newly elected Supervisor seats and City Council members no doubt will be installed before the last part of November. The appointments to the Metro Board will need to be made in December in order for Metro Board appointments to the RTC to be nominated at the first meeting in January.

Might it be better to have the Metro Boards' RTC Commissioner seats nominated in February (or March) rather than January? The Board of Supervisors and City Councils would then have more time to recruit and appoint their representatives. This would also give newly appointed Directors the opportunity to be nominated as RTC Commissioners.

The table below shows the Board seats that will expire in 12/04. An article published in the Sentinel 7/16/04 stated that Sheryl will "step down" from the Scotts Valley City Council. If this is true, this means her seat will have a replacement. Six of the 11 Board seats will need to be reappointed.

### CURRENT BOARD MEMBERSHIP TERMS

Revised 1/26/04

|   | <b>SEAT #</b> | <b>Appointing Authority</b>                                | <b>Term Began</b> | <b>Term Expires</b> | <b>First Served</b> |
|---|---------------|--|-------------------|---------------------|---------------------|
| Emily Reilly  | 1             | City of Santa Cruz   | 12/00             | <b>12/04</b>        | 12/00               |
| Marcela Tavantzis   | 2             | City of Watsonville<br>(Reapportioned 6102 to Watsonville) | 12/00             | <b>12/04</b>        | 6/02                |
| Mike Rotkin   | 4             | City of Santa Cruz   | 1/01              | <b>12/04</b>        | 1/03                |
| Mark Stone<br>(completing term of Jeff Almquist)                    | 6             | County of Santa Cruz                                       | 1/01              | <b>12/04</b>        | 1/04                |
| Dale Skillicorn<br>(completing term of Rafael Lopez/Ventura Phares) | 10            | City of Watsonville  | 1/01              | <b>12/04</b>        | 1/04                |
| Sheryl Ainsworth  | 11            | City of Scotts Valley                                      | 1/03              | 12/06               | 4/00                |

12B.e1

# SANTA CRUZ METROPOLITAN TRANSIT DISTRICT

**DATE:** September 24, 2004  
**TO:** Board of Directors  
**FROM:** Elisabeth Ross, Finance Manager  
**SUBJECT:** **APPOINTMENT OF DIRECTORS TO SANTA CRUZ CIVIC IMPROVEMENT CORPORATION**

## I. RECOMMENDED ACTION

**Staff recommends that the Board of Directors appoint five members to the Santa Cruz Civic Improvement Corporation (SCCIC) Board of Directors, each for a two-year term.**

## II. SUMMARY OF ISSUES

- The Santa Cruz Civic Improvement Corporation (SCCIC) is an independent non-profit organization established by the Transit District to assist the District in financial transactions.
- The Board of Directors of the Transit District is the appointing authority for the Board of Directors of the SCCIC.
- The two-year terms of the current SCCIC Board members are expiring and appointment of new Directors is required at this time. Current members may be reappointed.
- While SCCIC Board members are not required to be members of the SCMTD Board, the Board has historically appointed its own Directors to serve on the SCCIC Board.
- Staff will make a presentation on the SCCIC and potential future bond financing transactions at the Board workshop meeting on September 10, 2004.

## III. DISCUSSION

The bylaws of the Santa Cruz Civic Improvement Corporation (SCCIC) provide for the Board of Directors of the Santa Cruz Metropolitan Transit District to appoint the Directors to the SCCIC Board. Due to the expiration of the terms of the current Directors, the District Board must now consider the reappointment of current Directors or appointment of new Directors to the SCCIC Board.

The current members of the SCCIC Board are: Sheryl Ainsworth, Jan Beautz, Tim Fitzmaurice, Michelle Hinkle and Pat Spence. While the SCCIC is inactive, Directors are only required to attend the annual meeting of the SCCIC, which falls in October of each year. However, more meetings will be held in the event that the District participates in bond financing as a funding mechanism for MetroBase.

**IV. FINANCIAL CONSIDERATIONS**

None.

**V. ATTACHMENTS**

None.

# SANTA CRUZ METROPOLITAN TRANSIT DISTRICT

**DATE:** September 24, 2004

**TO:** Board of Directors

**FROM:** Frank L. Cheng, Project Manager

**SUBJECT: CONSIDERATION OF AUTHORIZING THE GENERAL MANGER TO EXECUTE AN AMENDMENT TO THE RNL DESIGN CONTRACT FOR ARCHITECTURAL/ENGINEERING SERVICES FOR THE METROBASE PROJECT**

## I. RECOMMENDED ACTION

**That the Board of Directors authorize the General Manager to execute a Change Order to the MetroBase Architectural/Engineering Contract with RNL Design.**

## II. SUMMARY OF ISSUES

- On August 8<sup>th</sup>, 2003, Santa Cruz METRO entered into a contract with RNL Design for Architectural/Engineering Services for the MetroBase Project in the amount of \$2,530,761.
- On July 23<sup>rd</sup>, 2004, METRO amended the contract for services beyond the original scope that required a Change Order in the amount of \$109,080.
- On August 27<sup>th</sup>, 2004, the Board of Director approved a new design option for the Maintenance building.
- As a result of the actions of the Board, METRO staff directed the RNL Design team to proceed to work with the new design of the MetroBase Maintenance Facility.
- The required work is beyond the original scope of work in the contract with RNL Design, requiring a Change Order in the amount of \$398,688.

## III. DISCUSSION

On August 8<sup>th</sup>, 2003 Santa Cruz METRO entered into an Architectural/Engineering Contract with RNL Design from Los Angeles, California in the amount of \$ 2,530,761. In order to improve the MetroBase design, critical items required additional services. Fuel equipment specifications and pile foundation design options were developed. These services pertained to the Operation facility on River Street.

Further decisions were made in respect to the Maintenance facility at 138 Golf Club Drive. The original RNL design kept the existing Maintenance building, and merged it with a new building. This renovation was compared to a demolition of the existing Maintenance building. On August 27<sup>th</sup>, 2004, RNL Design team presented the cost comparison to the Board of Directors. A new building cost less to construct than the renovation of the existing building and resulted in a better, more efficient facility. The savings between construction and the additional services

needed for the new design resulted in a lower cost in comparison to the original design which kept the existing building. The additional services consist of developing conceptual design and preparing construction documents. The fee is broken down to Project Management and Architecture, Maintenance Equipment, Civil and Structural, Mechanical/Electrical and Plumbing, Landscape Architecture, Communications and Security, and Cost Estimates. This change in the design represents an additional cost to the project, requiring a Contract Change Order.

Staff is recommending that the General Manager be authorized to execute a Change Order to the Architectural/Engineering Contract with RNL Design in the amount of \$398,688 to accommodate these revisions to the scope of services.

#### **IV. FINANCIAL CONSIDERATIONS**

This Change Order, in the amount of \$398,688 will increase the total contract with RNL Design to \$3,038,529. Funds are available in the MetroBase Project to cover this Change Order.

#### **V. ATTACHMENTS**

**Attachment A: Letter dated August 12<sup>th</sup>, 2004 from RNL Design**



Strategic Solutions  
by Design

August 12, 2004

Mr Frank Cheng  
MetroBase Project Manager  
Santa Cruz Metropolitan Transit District  
370 Encinal Street, Suite 100  
Santa Cruz, CA 95060

Re MetroBase Phase I  
Additional Services Proposal for Redesign of Maintenance Building

Los Angeles  
800 Wilshire Boulevard  
Suite 400  
Los Angeles CA 90017  
P 213 955 9775  
F 213 955 9885

Patrick M McKelvey AIA  
Katherine Diamond FAIA  
Charles E Boxwell AIA

[www.RNLdesign.com](http://www.RNLdesign.com)

Dear Frank:

SCMTD has requested RNL Design, and members of our consultant team, to provide professional services beyond the scope of our agreement with the District dated 8 August 2003 and the current amendment to the agreement. RNL Design is pleased to be able provide this proposal to redesign and modify the current Maintenance Building to meet the District's needs.

The redesign of the Maintenance Building and Golf Club Road site will provide the District a completely new, standalone facility on the Golf Club Road site. To simplify the building and reduce construction cost, the building structural system will be modified to load bearing "tilt-up" concrete exterior walls with conventional flat roofs. The general building (plan) layout will remain the same as the current design. The new design will provide the District the same number of bays as the previous design with approximately the same building area, but due to the increased building efficiency will meet the Program space requirements much better than re-using the existing Maintenance Building.

The following are descriptions of the tasks included in redesigning the Maintenance Building included in this proposal:

1. Develop Conceptual Design -- from the preliminary sketches and budget approved by the District. Conduct a two day "on site" charrette to refine and confirm the conceptual/operational design with the building users and District representatives. From the outcome of this workshop, revised "base drawings" will be developed for the design team to proceed with Construction Documents.
2. Prepare Construction Documents -- based on the approved concept base drawings. Design Development and Construction Document phase work will be combined for this building to prepare bidding drawings for the new Maintenance Building and revised Golf Club Road site Construction Documents will be prepared for District approval and for submission for Plan Check.

The scope of work for Plan Check, Bidding & Award, and Construction phase services are unchanged by this proposal. The scope of services and professional fee for these services is unchanged.

This added work will take approximately 65 working days, delaying the submission 957, submission the District and Plan Check by about three months. RNL will prepare a revised project schedule to reflect this delay in submission, plan check, bidding, award, and construction.

RNL Design will provide these additional services to SCMTD for the not to-exceed fee of three hundred ninety-eight thousand, six hundred and eighty-eight dollars (\$398,688). The fee is broken down as follows:

|                                     |                 |
|-------------------------------------|-----------------|
| Project Management and Architecture | \$ 157,500      |
| Maintenance Equipment               | \$ 40,732       |
| Civil and Structural                | \$ 123,319      |
| Mechanical/Electrical and Plumbing  | \$ 40,975       |
| Landscape Architecture              | \$ 15,162       |
| Communications and Security         | \$ 15,000       |
| <u>Cost Estimating</u>              | <u>\$ 6,000</u> |
| Total Additional Services Fee       | \$ 398,688      |

Per your direction and the project's need, these services have already commenced and are proceeding toward a submission of the Concept drawings for District approval. Please prepare a contract amendment increasing the scope and fee of our agreement. Provide us with a copy of the contract amendment for our records.

If you have any questions, please do not hesitate to contact me.

Sincerely,

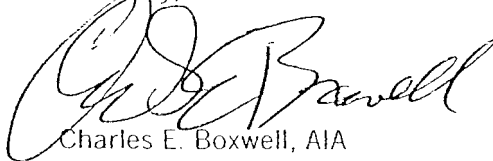

Charles E. Boxwell, AIA  
Associate Principal

CC" Les White  
Mark Dorfman  
Pat McKelvey



# SANTA CRUZ METROPOLITAN TRANSIT DISTRICT

**DATE:** September 24, 2004

**TO:** Board of Directors

**FROM:** Margaret Gallagher, District Counsel

**SUBJECT: CONSIDERATION OF AUTHORIZING THE GENERAL MANAGER TO EXECUTE A LEASE AMENDMENT WITH THE SCOTTS VALLEY TRANSIT CENTER TENANT TO EXTEND THE TERM, INCLUDE JANITORIAL DUTIES AND PROVIDE FOR THE REPAYMENT OF A PG&E BILL**

## 1. RECOMMENDED ACTION

**Authorize the General Manager to execute a Lease Amendment with the Scotts Valley Transit Center Tenant to Extend the Term, Provide for Janitorial Duties and Provide for the Repayment of a PG&E Bill.**

## II. SUMMARY OF ISSUES

- Steve Dymerski and Ok Hyun Cho-Byun dba the Blue Dolphin has been the tenant of the Scotts Valley Transit Center since September 1, 2002.
- The Blue Dolphin's Lease will terminate on September 30, 2004. At this time, Blue Dolphin has requested a Lease Extension through July 31, 2005, as provided for under the terms of the Lease.
- Additionally, the Ark Janitorial Services recently informed METRO that due to recent medical issues, it could no longer provide janitorial services to the Scotts Valley Transit Center effective August 31, 2004. Blue Dolphin has expressed an interest in taking over the janitorial contract at this time.
- Blue Dolphin owes METRO the balance on a utility bill having paid \$2,178.95 towards the total owed of \$4,357.90. Blue Dolphin has requested a payment plan to allow for monthly payments of \$75.00 towards the remaining \$2,178.95 until the balance is paid in full.

## III. DISCUSSION

Steve Dymerski and Ok Hyun Cho-Byun have been operating the Blue Dolphin at the Scotts Valley Transit Center (SVTC) for approximately two years. The Blue Dolphin is a café providing Internet connections for its customers. Blue Dolphin's Lease will terminate on September 30, 2004. At this time, Blue Dolphin has requested a Lease Extension through July 31, 2005, as provided for under the terms of the Lease.

On March 1, 2004, METRO issued a Request for Proposals for the janitorial duties at the SVTC. Ark Property Maintenance was the lowest bidder with a bid of \$1,500.00 per



month. The Blue Dolphin also bid on the project with a bid of \$1,600.00. METRO entered into a contract with Ark to provide janitorial services to the Scotts Valley Transit Center. The owner of the Ark recently informed METRO that due to medical issues, the Ark would no longer be able to provide services and was canceling its contract effective August 31, 2004. At this time, the Blue Dolphin has requested that the janitorial contract be awarded to it, for the same compensation METRO was paying the Ark. Because the Blue Dolphin was the second lowest bidder and the initial contract is less than 6 months old METRO is able to authorize the Blue Dolphin to contract for these services. Attachment B contains the specifications for Janitorial Services for the Scotts Valley Transit Center.

METRO mistakenly paid Blue Dolphin's utilities at the Scotts Valley Center for the past two years. The Lease requires Blue Dolphin to pay its own utilities at the Center. Blue Dolphin paid \$2,178.95 on July 9, 2004 towards the \$4,357.90 owed. They have requested a payment plan to allow for monthly payments of \$75.00 towards the remaining \$2,178.95 until the balance is paid in full.

#### **IV. FINANCIAL CONSIDERATIONS**

The Janitorial Contract will cost METRO \$15,000.00 for the next 10 months.

#### **V. ATTACHMENTS**

- Attachment A:** Proposed Lease Amendment  
**Attachment B:** Specifications for Janitorial Services At the Scots Valley Transit Center

**SANTA CRUZ METROPOLITAN TRANSIT DISTRICT  
FIRST AMENDMENT TO LEASE AGREEMENT**

THIS FIRST AMENDMENT TO LEASE AGREEMENT is made effective September 1, 2004, between the SANTA CRUZ METROPOLITAN TRANSIT DISTRICT, a political subdivision of the State of California, hereinafter called "District", and Steve Dymerski and Ok Hyun Cho-Byun ("Tenant") dba **The Blue Dolphin**, who agree as follows:

I. RECITALS

- 1.1 On September 1, 2002, Tenant leased from District the certain real property commonly known as the Scotts Valley Transit Center (hereinafter "Center") for the purposes of operating a Snackshop and Newsstand business. The Lease included the provision that Tenant would be responsible for its own utility costs.
- 1.2 On September 1, 2003, Tenant and District agreed to a Lease extension extending the lease for one year, to expire on July 31, 2004.
- 1.3 Thereafter, Tenant and District agreed to extend the Lease to September 30, 2004.
- 1.4 The multi-purposes of this First Amendment is to provide for the following:
  - a. Extension of the current Lease for an additional year, beginning October 1, 2004 and terminating on July 31, 2005;
  - b. Award of the current janitorial contract for the Scotts Valley Transit Center to Tenant; and
  - c. Reimbursement of monies paid by District on Tenant's behalf for utilities.
- 1.5 Article 20.1.18 of the Lease requires that any amendment to the Agreement be in writing and signed by the duly authorized representatives of both parties.
- 1.6 This Lease Amendment constitutes the First Amendment under the Lease Agreement dated September 1, 2002.

## II. AGREEMENT OF REIMBURSEMENT OF UTILITIES PAID BY METRO

- 2.1 Tenant agrees that District paid \$4,357.90 in utility costs that should have been paid by Tenant.
- 2.2 Tenant and District agree that Tenant has made a payment of \$2,178.95 on July 9, 2004 and currently owes District \$2,178.95.
- 2.3 Tenant and District further agree that Tenant will pay \$75.00 per month beginning October 1, 2004 and on the first day of each and every month thereafter until the debt has been paid in full. This provision shall survive the expiration of this amendment until the debt is paid in full.
- 2.4 Tenant and District further agree that Tenant will promptly pay all current and future utility bills directly to Pacific Gas & Electric and will continue to keep the gas and electric account in Tenant's name and bear all responsibility for such billings until the termination of the Lease extension.

## III. EXTENSION OF TERM

- 3.1 Tenant and District agree to extend the Lease term from October 1, 2004 through July 31, 2005.

## IV. JANITORIAL DUTIES

- 4.1 Tenant and District agree that Tenant will execute the janitorial services contract for the Scotts Valley Transit Center effective October 1, 2004, and Tenant will be paid pursuant to that contract \$1,500.00 per month in exchange for all required services.

## V. REMAINING TERMS AND CONDITIONS.

- 5.1 All other provisions of the Agreement that are not affected by this amendment shall remain unchanged and in full force and effect.

## VI. AUTHORITY

- 6.1 Each party has full power and authority to enter into and perform this First Amendment to the Agreement and the person signing this Amendment on behalf of each has been properly authorized and empowered to enter into it. Each party further acknowledges that it has read this Amendment, understands it, and agrees to be bound by it.

IN WITNESS THEREOF, this First Amendment to the Agreement is executed by District and Tenant has affixed his or her signature(s) the day and year first hereinabove written.

DISTRICT - SANTA CRUZ METROPOLITAN TRANSIT DISTRICT

B Y : \_\_\_\_\_ DATE: \_\_\_\_\_  
Leslie White  
General Manager

TENANT - BLUE DOLPHIN

BY: \_\_\_\_\_ - - DATE: \_\_\_\_\_  
Steve Dymerski

BY: - - \_\_\_\_\_ DATE: \_\_\_\_\_  
Ok Hyun Cho-Byun

Approved as to form:

BY: \_\_\_\_\_  
Margaret Gallagher  
District Counsel

## PART III

### SPECIFICATIONS FOR JANITORIAL SERVICES AT THE SCOTTS VALLEY TRANSIT CENTER

#### 1. INTRODUCTION

The specifications described below set forth the minimum requirements for the quantity and quality of work to be provided hereunder. The provision of Janitorial Services at the Scotts Valley Transit Center (SVTC) shall meet or exceed the specifications attached hereto. As used herein, the term “work” refers to the articles, equipment, materials, supplies and labor as specified, designated or otherwise required by the Request for Proposal (RFP). Additional terms, conditions and requirements pertaining to the methods and manner of performing the work are described elsewhere in the RFP. All janitorial services provided as a result of this RFP shall be as per best commercial practices.

#### 2. GENERAL INFORMATION

SVTC is located adjacent to the Scotts Valley Roller Rink on Kings Village Road, Scotts Valley, California. Current SVTC (lobby and restrooms) days and hours of operation are: Monday through Friday: 6:00am to 6:00pm. Building areas will be opened and closed by the District’s lobby tenant.

#### 3. MINIMUM WORK REQUIREMENTS

##### 3.1 RESTROOMS (minimum of four times daily – 8am/11am/4pm/7pm)

- 3.1.1 Clean restrooms. Keep restrooms in an orderly and clean state.
- 3.1.2 Clean and sanitize toilets and sinks.
- 3.1.3 **Provide** and stock restroom supplies as needed.
- 3.1.4 Clean fixtures (e.g., hand dryer, trash receptacles).
- 3.1.5 Empty trash receptacles and women’s sanitary napkin container.
- 3.1.6 Scrub and sanitize walls. Remove mold from tiles.
- 3.1.7 Clean mirrors.
- 3.1.8 Sweep and mop floors.
- 3.1.9 Scrub doors and partitions and polish metal surfaces.
- 3.1.10 Scrub entry doors and adjacent areas.
- 3.1.11 Remove all graffiti immediately. If unable to remove, report to Facilities Maintenance (see item 3.4.3 below).

##### 3.2 TRANSIT CENTER LOBBY (Minimum two times daily – 11am/7pm)

- 3.2.1 Keep public Transit Center lobby in an orderly and clean state
- 3.2.2 Empty trash receptacles.
- 3.2.3 Spot mop floor (use “Wet Floor” signs as necessary).
- 3.2.4 Safety-check auto doors.
- 3.2.5 Remove all graffiti and posters from lobby.
- 3.2.6 Clean interior glass and doors.
- 3.2.7 Clean interior ledges.
- 3.2.8 Clean benches, tables, and chairs.
- 3.2.9 Sanitize public conveniences, e.g., drinking fountains and pay phones.

3.3 **BUS AREAS AND PARKING LOT AREA. (Minimum two times daily – 8am/4pm)**

- 3.3.1 Empty parking lot trashcans and recycling cans.
- 3.3.2 Make sure pedestrian areas are kept clean and safe.
- 3.3.3 Remove trash from landscaping and sidewalk area.
- 3.3.4 Clean sidewalk area around facility (**minimum two times weekly, and as needed to maintain cleanliness – in evenings**). Steam cleaning or pressure washing preferred and in accordance with District’s storm water pollution prevention program.

3.4 **OTHER DUTIES**

Report any problems to the District’s Facilities Maintenance Department at 426-6080 ext. 117. Leave a message if calling when the office is closed.

- 3.4.1 See that all doors to facility, clocks, and lighting are functioning properly. Contact the Facilities Department if there are any problems.
- 3.4.2 Make sure all trash receptacles are clean and in good condition; report all damage.
- 3.4.3 **Report immediately** any vandalism, or any graffiti that cannot be removed from walls, benches, or signage, including the bus and public parking areas of the facility.

4. **ADDITIONAL REQUIREMENTS AND SPECIFICATIONS**

- 4.1 Interested contractors may contact David Konno, Manager of Facilities Maintenance Department to arrange for a pre-proposal walk-through of the job site.
- 4.2 Contractors must specify on their proposal any aspects of the specifications that they do not intend to cover or perform as part of their offer.
- 4.3 Work is to be performed by a fully licensed and insured business owner. Work shall be performed in a manner that complies with all existing federal, state, and local construction and environmental codes, and with the District Hazards Communication Program and Injury Prevention Program. Material Safety Data Sheets (MSDS) shall be provided for all applicable chemicals and materials to be brought on to District property.
- 4.4 The work area shall be cleared of all materials and refuse upon completion of work. All debris and refuse shall be the property of the Contractor, who shall dispose of it properly, in compliance with all federal, state, and local requirements.
- 4.5 Contractor is responsible to return to the District in good condition any equipment, including keys, issued to it by the District. If the contractor fails or refuses to return District-issued equipment within five days of the conclusion of the contract work, the District shall deduct the actual costs to repair or replace the equipment not returned from the final payment owed to contractor, or take other appropriate legal action at the discretion of the District.

5. **PROPOSAL FEE**

Offeror shall submit a firm fixed monthly lump sum fee for janitorial services required. Monthly lump sum fee shall include all costs, including labor, materials, janitorial supplies, freight, applicable taxes, and travel. Offeror shall provide a separate hourly rate schedule for unscheduled additional janitorial maintenance. Rates quoted shall remain firm for a period of one year from the effective date of the contract. At the option of the District, this contract may be renewed for four (4) additional one (1) year terms. Rate increases may be negotiated for the option year terms so long as the increase does not exceed the annual percent change of the Consumer Price Index (CPI) for the San Francisco, Oakland, and San Jose area. CPI increase shall apply to extension years only.

6. **REJECTION OF PROPOSALS**

Failure to meet the requirements for the Request for Proposals will be cause of rejection of the proposal. The District may reject any proposal if it is conditional, incomplete or contains irregularities. The District may waive an immaterial deviation in the proposal. Waiver of an immaterial deviation shall in no way modify the Balance of the

Proposal documents or excuse the offeror from full compliance with the contract documents if the offeror is awarded the contract. The District reserves the right to not award the contract, should it determine that the proposals are not in its best interest.

**7. MINIMUM PROPOSAL REQUIREMENTS**

- 7.1 Description of Work Proposed - Firm shall provide a description of the approach to the tasks outlined in “Part II – Work Requirements and Specifications” and provide a work program, including any support required by the District.
- 7.2 Experience & Qualifications - This section should provide a summary description of the Contractor’s overall qualifications for this contract.
- 7.3 References - Prospective Contractor shall provide a list of other customers for which they have provided similar services within the past twenty-four months, including contact names, addresses and telephone numbers.
- 7.4 Cost Proposal -Proposals should include a monthly rate to provide services specified. This rate shall remain firm for a one-year period.
- 7.5 Insurance - The District requires minimum levels of insurance as specified in the General Conditions of the Contract. Contractor shall provide Certificates of Insurance in accordance with these requirements.
- 7.6 Conflict of Interest - The prospective Contractor shall disclose any financial, business or other relationship with the District or any of its officers or officials that may have an impact upon the outcome of the work. The prospective Contractor shall also list current clients who may have a financial interest in the outcome of the work.

**8. EVALUATION CRITERIA**

Submitted proposals shall be reviewed, evaluated and ranked by an evaluation committee comprised of District staff. Final selection shall be based upon the following considerations:

| <b>Criteria</b>   | <b>Points Possible</b> |
|---|------------------------|
| Qualifications/Experience - an evaluation of the quality of the proposed staff and the skills and availability of substitute staff. | 30                     |
| References.   | 20                     |
| Price – Offerors Price Proposal   | 50                     |
| <b>Total Points Possible</b>  | <b>100</b>             |